



CDMA/FM RECEIVE AGC AMPLIFIER AS3802

Key Features

- Supports dual mode operation.
- 50 to +50db gain control guaranteed.
- Single 3.6V supply.
- Temperature and supply stabilized.
- Power down feature.
- 80MHz to 250MHz operation.
- Silicon BiCMOS process.
- Miniature surface mount 16 pin, 150 mil SSOP package.

Compatibility

The AS3802 is designed to be functionally or/and pin compatible to the following products:

- RF9907 (RF Micro Devices), pin compat.
- Q5500 (Qualcomm), pin compat.
- CXA3001N (Sony)

General Description

The AS3802 is a gain controlled amplifier designed for the receive section of dual mode CDMA/FDM, TDMA/FDM or FM/FDM cellular phones.

Key specifications like gain range noise figure, IP3, temperature range and other specifications are designed to be in line with the IS-95 Standard for CDMA cellular communications.

The circuit is designed for narrow band IF applications but can also be used in wideband applications.

Applications

- Digital cellular systems with receiving methods: CDMA/FDM, TDMA/FDM, FM/FDM and TDMA/TDD.
- Examples: IS-95 CDMA, IS-54 DAMPS, AMPS, PWT.
- Cordless phones analog/digital.
- General purpose linear IF amp's.
- WLL / WLAN

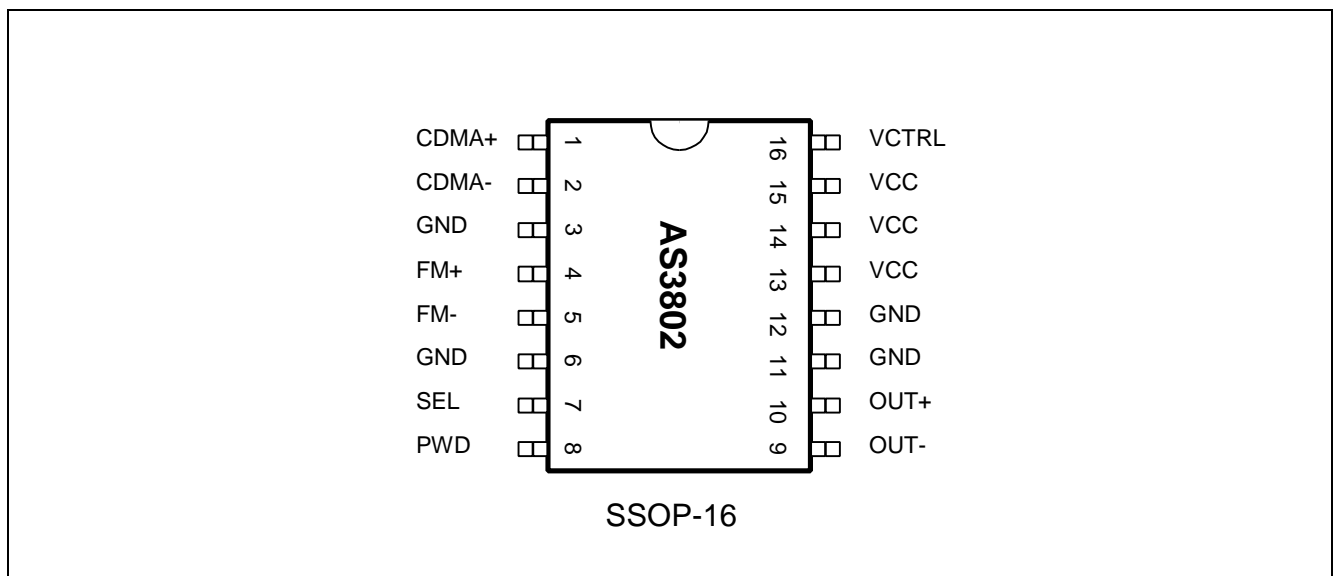

This document contains information on products under development. Austria Mikro Systeme Intl. AG reserves the right to change or discontinue this product without notice.

Absolut Maximum Ratings (non operating)

Symbol	Parameter	min	max	Unit	Note
VDD	Positive Supply Voltage	-0.5	7	V	
GND	Analog Ground	0	0	V	
Vin	Voltage at every Input Pin)	Gnd-0.5	VDD+0.5	V	
Iin	Input Current (into any pin except supply pins and except low leakage pin)	-40	40	mA	
Iin_15	Input Current into Low Leakage Pin	-25	25	mA	
H	Humidity Noncondensing				1)
ESD	Electrostatic Discharge		1000	V	2)
Tstg	Storage Temperature	-55	125	deg C	
Tlead	Lead Temperature		260	deg C	3)

Notes:

- 1) Defined DIN 40040 cond. F.
- 2) HBM: R=1.5kOhm, C=100pF.
Open collector outputs have less ESD protection because the protection diode to the positive supply cannot be implemented (The output swing is higher than Vpos.+0.7V).
- 3) 260 deg C for 10 sec (Reflow and wave soldering), 360 deg C for 3 sec (Manual soldering).

The above figures conform to CMOS standard for low leakage application.

Recommended Operating Conditions

Symbol	Parameter	min	typ	max	Unit	Note
VDD	Positive Supply Voltage		3.6		V	1)
GND	Analog Ground	0	0	0	V	
Idd	Supply Current		10	14	mA	2)
Tamb	Ambient Temperature Range, Operating Range	-30		+80	deg C	

Notes:

- 1) 3.6V ± 5%.
- 2) Measured at pin VDD, see test schematic, no signal.

RX AGC Electrical Characteristics

Parameter	min	typ	max	Unit	Note
Frequency Range		80-250		MHz	$f_{-3dB}=250\text{MHz}$
Maximum Gain	50			dB	$V_G=3\text{V}$
Minimum Gain			-50	dB	$V_G=0.2\text{V}$
Noise Figure		6.5		dB	max Gain
Input IP3		-7 -14		dBm dBm	min Gain FM min Gain CDMA 1)
Output CP1		-25		dBm	
Gain Var. in +/-630 kHz bandwidth centered at 85MHz		+/-0.05		dB	
Gain Slope Linearity (over any 6dB segment)		+/- 3		dB	-32 to +72 deg.C
Gain Control Voltage Range		0.2-3		V	0.2V min Gain 3.0V max Gain ref. To GND
Gain Control Input Impedance		16		k Ω	
Current Consumption		10	14	mA	
Input Resistance		1k diff. 850 sing.		Ω Ω	CDMA FM
Output Impedance		500		Ω	500 Ω differential outside (Reff. =250 Ω)
CDMA to FM Isolation		30		dB	
Power Down Mode					2)

Notes:

Measurements referred to 85MHz.

1) Two tone measurement is used.

$f_1=86\text{MHz}$; $f_2=87\text{MHz}$; SEL=High for CDMA mode, SEL=Low for FM mode.

2) High=Active, Low=Power save, Input impedance $\geq 16\text{k}\Omega$.

Pin Description

Pin#	Symbol	Function
1	CDMA+	CDMA Positive Differential Input
2	CDMA-	CDMA Negative Differential Input
3	GND	Analog Ground
4	FM+	Single Ended Analog Input
5	FM-	Analog Ground Connection (RX FM Input Reference)
6	GND	Analog Ground
7	SEL	Select, CMOS Input $V_{\text{SELECT}} \geq 3.4\text{V}$, CDMA Mode Select $V_{\text{SELECT}} \leq 0.5\text{V}$, FM Mode Select
8	PWD	Power down, CMOS Input $V_{\text{PWD-RX}} \geq 3.4\text{V}$, RX-AGC Active $V_{\text{PWD-RX}} \leq 0.5\text{V}$, RX-AGC Off
9	OUT-	Analog Differential Output
10	OUT+	Analog Differential Output
11	GND	Analog Ground
12	GND	Analog Ground
13	VCC	VCC Power Supply
14	VCC	VCC Power Supply
15	VCC	VCC Power Supply
16	VCTRL	Analog Control Input $V_{\text{CTRL}} = 0.2\text{V}$, Low Gain Rail; $V_{\text{CTRL}} = 3\text{V}$, High Gain Rail

Definition of CDMA Source Impedance, Z_S , and AS3802 Input Impedance Z_{IN}

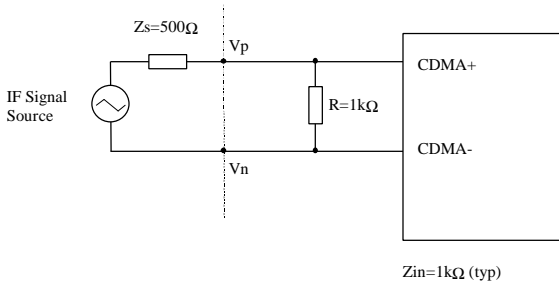

The value of the $1k\Omega$ resistor is calculated in the matching network between the filter and the input of the RX-APM.

Definition of FM Source Impedance, Z_S , and AS3802 Input Impedance Z_{IN}

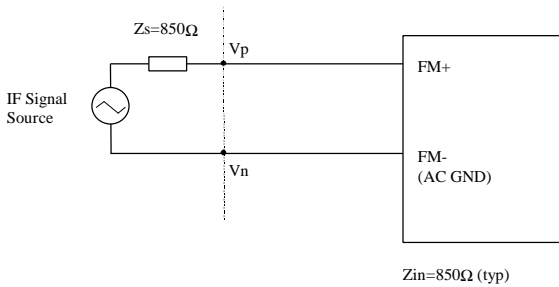

AC GND is defined as FM- in the package pin definition.

Definition of Load Impedance, Z_L , and AS3802 Output Impedance Z_O

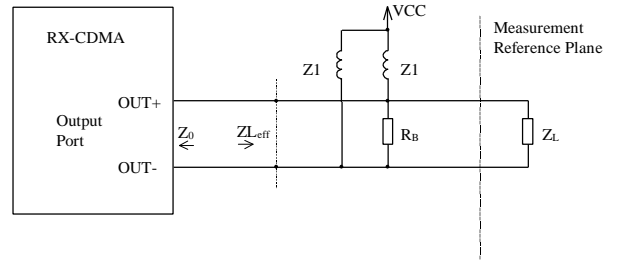

- | | |
|-------------------------------|---|
| RX-CDMA Output Port Impedance | $Z_O > 5k\Omega$ |
| Load Impedance | $Z_L = 500\Omega$ |
| Bias Resistor | $R_B = 500\Omega$ * |
| Bias Inductors | $L = \text{Choke},$
$\omega.L \gg R_B$ * |
| Effective Load | $Z_{Leff} = 250\Omega$ |

*Note:

Z_1 can be a resistor or a choke.
 If it is a resistor $Z_1 = R_1 = 250\Omega$ then R_B is not used.
 If it is a choke, $\omega.L \gg R_B$ and $R_B = 500\Omega$.

Transfer Characteristic

FM RX AGC

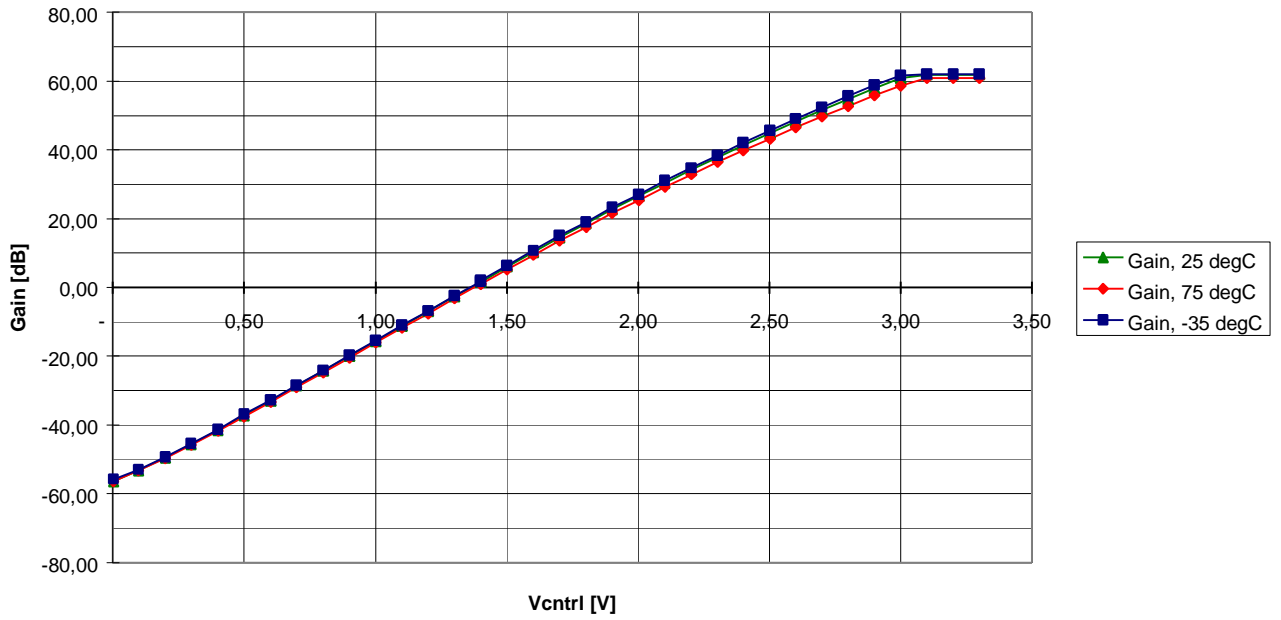

CDMA RX AGC

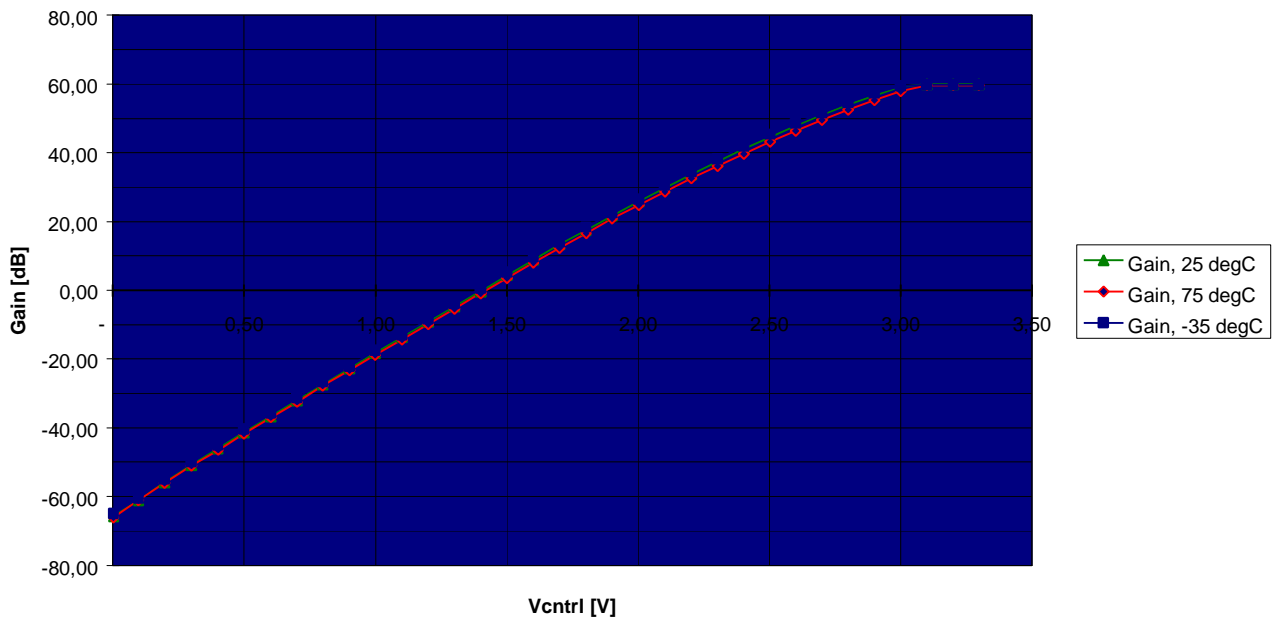

Intermodulation Performance

RX CDMA IIP3

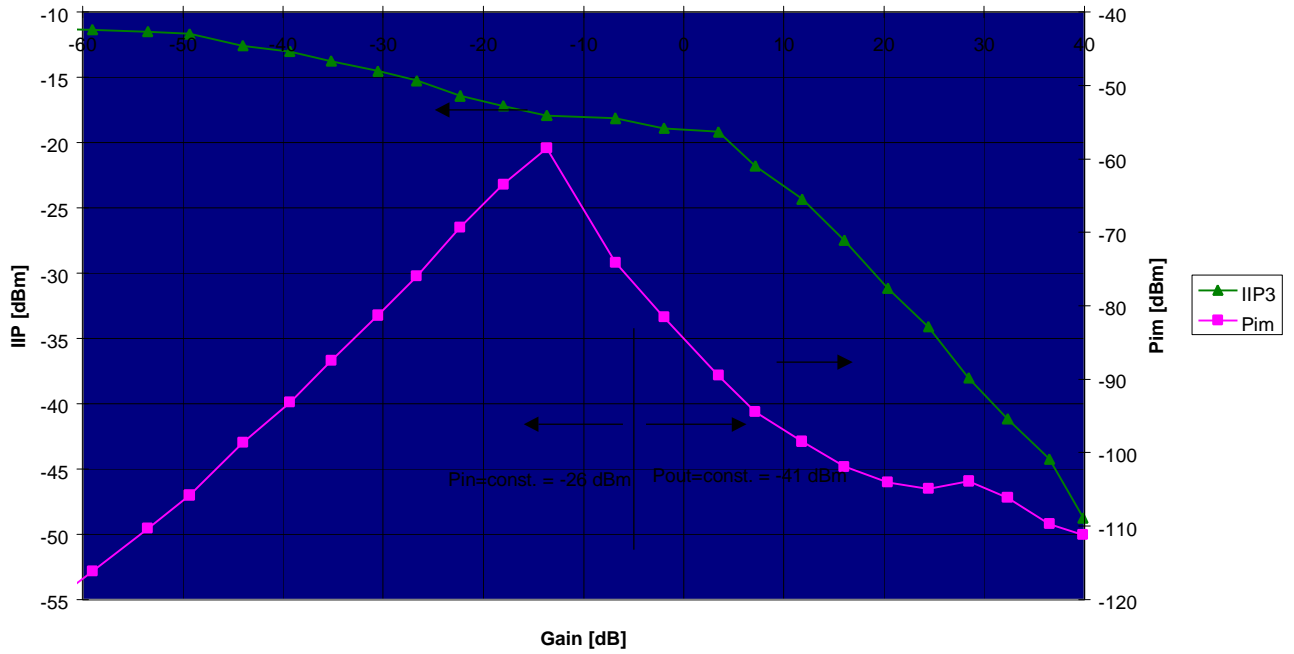

RX FM IIP3

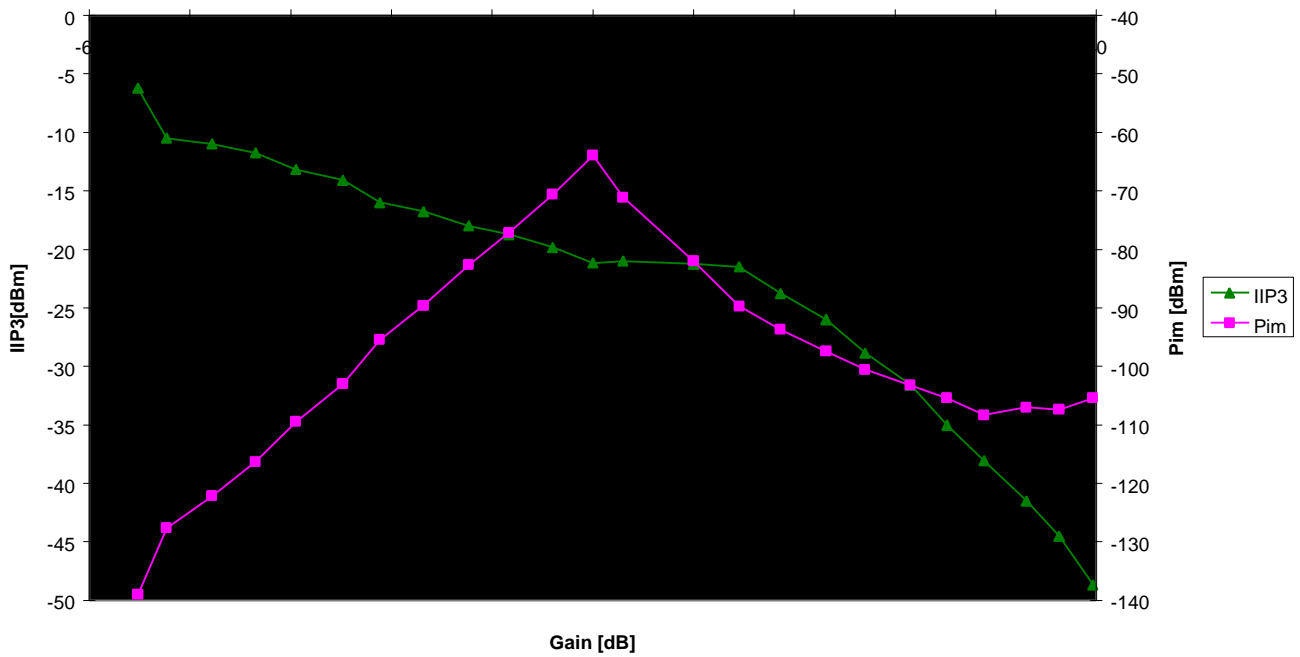

Compression Behaviour

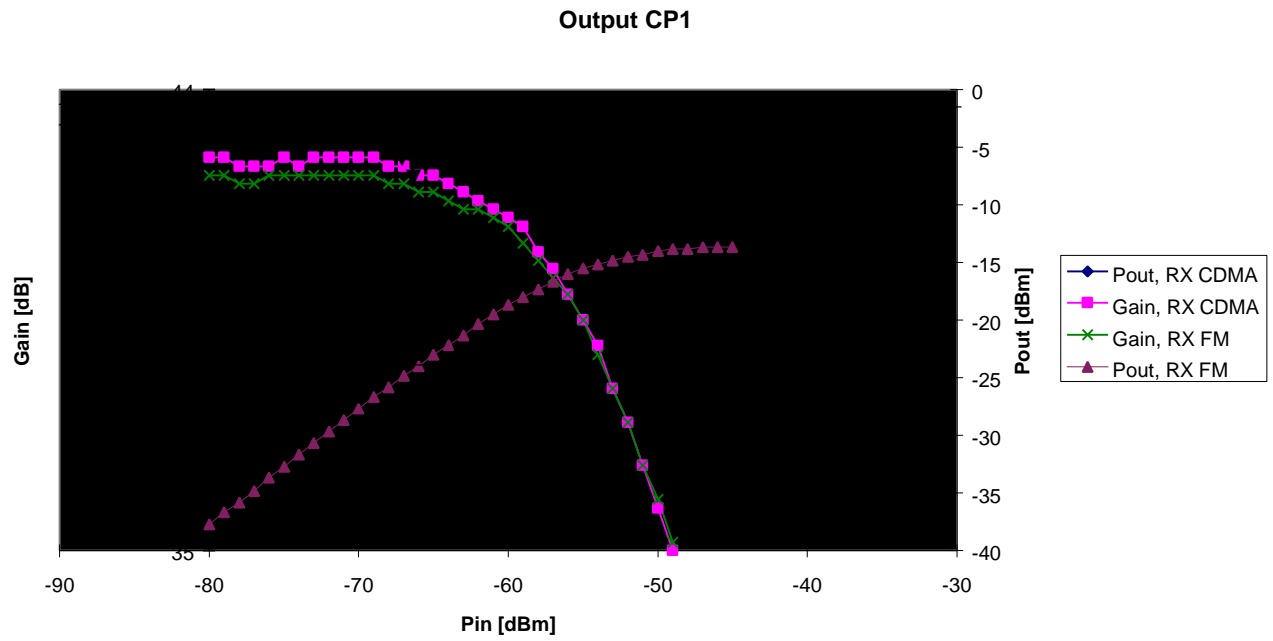

Typical Application @ 85MHz

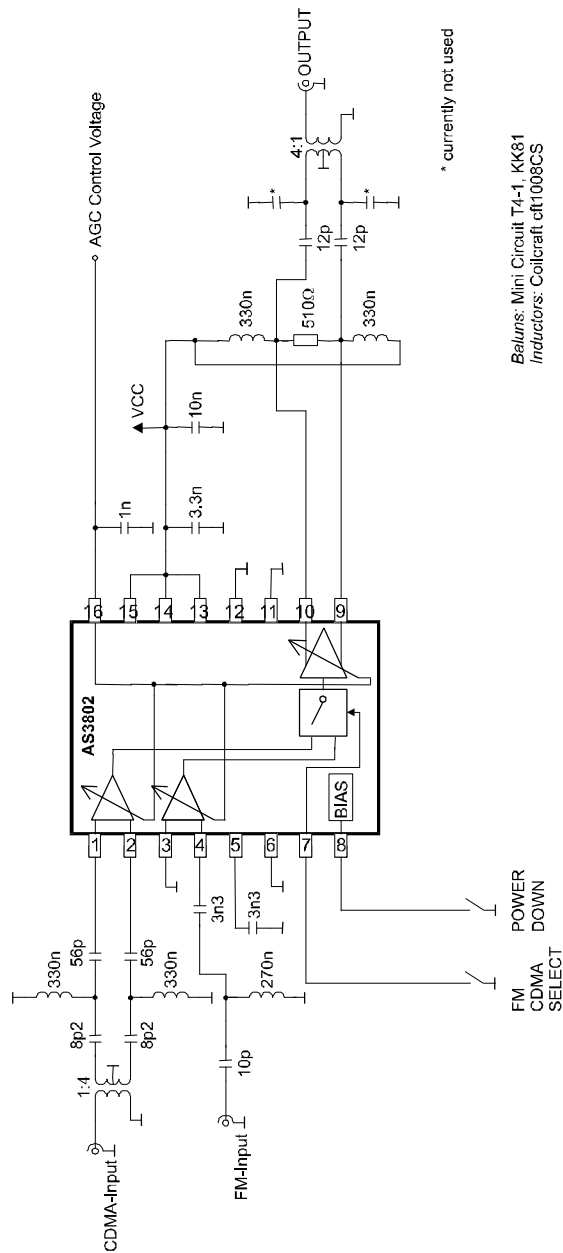

The information furnished herein by Austria Mikro Systeme International is substantially correct and accurate. However, Austria Mikro Systeme International shall not be liable to licensee or any third party for any damages, including but not limited to personal injury, property damage, loss of profits, loss of use, interrupt of business or indirect, special incidental or consequential damages, of any kind, in connection with or arising out of the furnishing, performance or use of the technical data. No obligation or liability to licensee or any third party shall arise or flow out of Austria Mikro Systeme International's rendering of technical or other services.

Austria Mikro Systeme International makes no warranty, express, statutory, implied, or by description regarding the information set forth herein or regarding the freedom of the described devices from patent infringement. Austria Mikro Systeme International reserves the right to change specifications and prices at any time and without notice. Therefore, prior to designing this product into a system, it is necessary to check with Austria Mikro Systeme International for current information. This product is intended for use in normal commercial applications. Applications requiring extended temperature range, unusual environmental requirements, or high reliability applications, such as military, medical life-support or life-sustaining equipment are specifically *not* recommended without additional processing by Austria Mikro Systeme International for each application.

Copyright © 1998, Austria Mikro Systeme International AG, Schloß Premstätten, 8141 Unterpremstätten, Austria. All rights reserved. The material herein may not be reproduced, adapted, merged, translated, stored, or used without the prior written consent of the copyright owner.