

HF105F-1 (JQX-105F-1)

MINIATURE HIGH POWER RELAY



File No.:E134517



File No.:R50050266



File No.:CQC02001001955



Features

- 30A switching capability
- 4kV dielectric strength (between coil and contacts)
- Heavy load up to 7,200VA
- PCB coil terminals, ideal for heavy duty load
- Unenclosed, Wash tight and dust protected types available
- Class F insulation available
- Environmental friendly product (RoHS compliant)
- Outline Dimensions: (32.2 x 27.0 x 20.1) mm

CONTACT DATA

Contact arrangement	1A	1B	1C(NO)	1C (NC)
Contact resistance	50mΩ (at 1A 24VDC)			
Contact material	AgSnO ₂ , AgCdO			
Max. switching capacity	7200VA/560W	3600VA/280W	4800VA/560W	2400VA/280W
Max. switching voltage	277VAC / 28VDC			
Max. switching current	40A	15A	20A	10A
JQX-105F-1 rating	30A 240VAC 20A 28VDC	15A 240VAC 10A 28VDC	20A 240VAC 20A 28VDC	10A 240VAC 10A 28VDC
JQX-105F-1L rating	25A 240VAC 20A 28VDC	15A 240VAC 10A 28VDC	20A 240VAC 20A 28VDC	10A 240VAC 10A 28VDC
Mechanical endurance	1 x 10 ⁷ OPS			
Electrical endurance	1 x 10 ⁵ OPS			

CHARACTERISTICS

Insulation resistance	1000MΩ (at 500VDC)	
Dielectric strength	Between coil & contacts	2500/4000VAC 1min
	Between open contacts	1500VAC 1min
Operate time (at nomi. volt.)	15ms max.	
Release time (at nomi. volt.)	10ms max.	
Ambient temperature	Class B	DC:-55°C to 85°C AC:-55°C to 60°C
	Class F	DC:-55°C to 105°C AC:-55°C to 85°C
Shock resistance	Functional	100m/s ² (10g)
	Destructive	1000m/s ² (100g)
Vibration resistance	10Hz to 55Hz 1.5mm DA	
Humidity	98% RH, 40°C	
Termination	PCB	
Unit weight	Approx. 36g	
Construction	Unenclosed (Only for DC coil), Wash tight, Dust protected	

- Notes:** 1) The data shown above are initial values.
2) Please find coil temperature curve in the characteristic curves below.

COIL

Coil power	DC type: 900mW; AC type: 2VA
------------	------------------------------

SAFETY APPROVAL RATINGS

UL & CUR	1 Form A	30A 277VAC 30A 28VDC 2HP 250VAC 1HP 125VAC 277VAC(FLA=20)(LRA=60)	
		1 Form B (NC)	15A 277VAC 10A 28VDC 1/2HP 250VAC 1/4HP 125VAC 277VAC(FLA=10)(LRA=33)
	1 Form C	NO	30A 277VAC 20A 277VAC 10A 28VDC 2HP 250VAC 1HP 125VAC 277VAC(FLA=20)(LRA=60)
		NC	20A 277VAC 10A 277VAC 10A 28VDC 1/2HP 250VAC 1/4HP 125VAC 277VAC(FLA=10)(LRA=33)
	TÜV	15A 250VAC COSφ=0.4	

Notes: Only some typical ratings are listed above. If more details are required, please contact us.



HONGFA RELAY

ISO9001、ISO/TS16949、ISO14001、OHSAS18001 CERTIFIED

2007 Rev. 2.00

COIL DATA

at 23°C

Nominal Voltage VDC	Pick-up Voltage VDC	Drop-out Voltage VDC	Max. Allowable Voltage VDC	Coil Resistance Ω
5	3.75	0.5	6.5	27 x (1±10%)
6	4.50	0.6	7.8	40 x (1±10%)
9	6.75	0.9	11.7	97 x (1±10%)
12	9.00	1.2	15.6	155 x (1±10%)
15	11.25	1.5	19.5	256 x (1±10%)
18	13.50	1.8	23.4	380 x (1±10%)
24	18.00	2.4	31.2	660 x (1±10%)
48	36.00	4.8	62.4	2560 x (1±10%)
70	52.50	7.0	91	5500 x (1±10%)
110	82.50	11	143	13450 x (1±10%)

Nominal Voltage VAC	Pick-up Voltage VAC	Drop-out Voltage VAC	Max. Allowable Voltage VDC	Coil Resistance Ω
12	9.6	2.4	15.6	25 x (1±10%)
24	19.2	4.8	31.2	100 x (1±10%)
120	96.0	24.0	156	2500 x (1±10%)
208	166.4	41	270.4	11000 x (1±10%)
220/240	192	48	286	13490 x (1±10%)
277	220	54	360.1	15000 x (1±10%)

Notes: When requiring pick-up voltage < 80% of nominal voltage, special order allowed.

ORDERING INFORMATION

HF105F-1 /		018	D	T	-1H	S	T	F	(XXX)
Type¹⁾	HF105-1: 30A (Unenclosed, only for DC coil) HF105-1L: 25A (Unenclosed, only for DC coil)								
	HF105F-1: 30A HF105F-1L: 25A JQX-105-1/JQX-105-1L (Old type) JQX-105F-1/JQX-105F-1L (Old type)								
Coil voltage DC: 5 to 110VDC AC: 12 to 277VAC									
Coil voltage form D: DC A: AC									
Termination	6 : With Pin NO.6, Dielectric Strength Between Coil and Contact: 2500VAC								
	T : Without Pin NO.6, Dielectric Strength Between Coil and Contact: 4000VAC								
	Nil: Without Pin NO.6, Dielectric Strength Between Coil and Contact: 2500VAC								
Contact arrangement 1H: 1 Form A 1D: 1 Form B 1Z: 1 Form C									
Construction²⁾	S: Wash tight								
	Nil: Dust protected (For HF105F-1, HF105F-1L) Unenclosed (For HF105-1, HF105-1L)								
Contact material		T: AgSnO ₂			Nil: AgCdO				
Insulation standard		F: Class F			Nil: Class B				
Customer special code³⁾ e.g. (551) stands for RoHS compliant (Cadmium containing contacts) (Only for special requirements) (555) stands for RoHS compliant (Cadmium-free contacts)									

Notes: 1) We have now gradually updated our ordering information. We suggest new type should be selected. If necessary, old type can be kept for some period for the old customers.

2) Under the ambience with dangerous gas like H₂S, SO₂ or NO₂, wash tight type is recommended; please test the relay in real applications. If the ambience allows, dust protected is preferentially recommended.

3) HF105F-1 is an environmental friendly product. Please mark a special code (555) or (551) when ordering. (551) stands RoHS compliant with Cadmium contact; (555) stands for RoHS compliant with Cadmium-free contact.

HF105F-1

1 Form A

Outline Dimensions

Wiring Diagram
(Bottom view)

PCB Layout
(Bottom view)

With 6# terminal

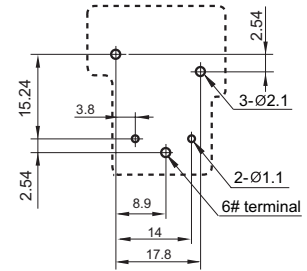
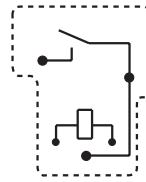
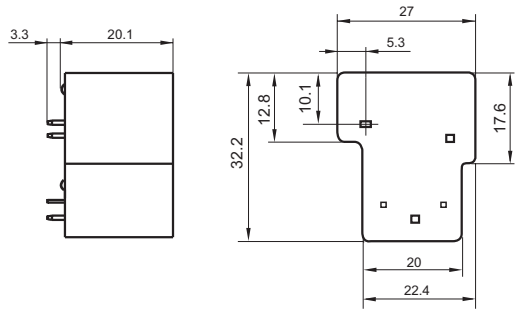

Without 6# terminal

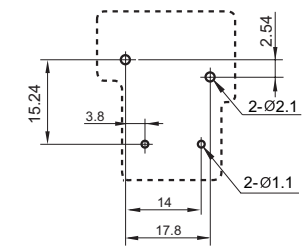
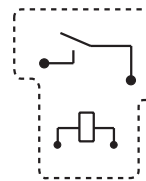
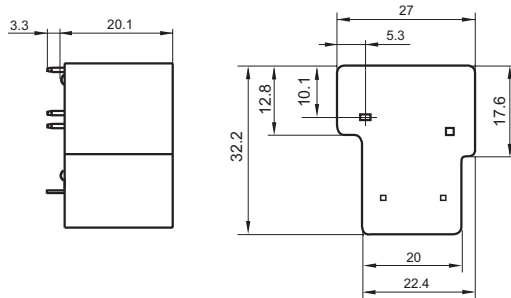

1 Form B

With 6# terminal

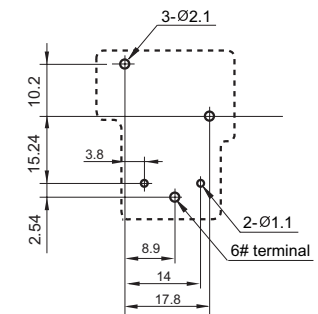
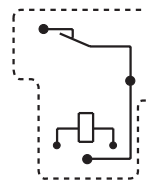
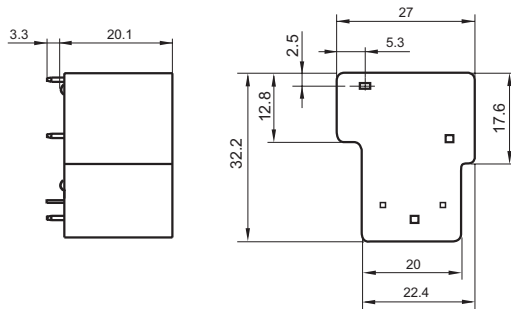

Without 6# terminal

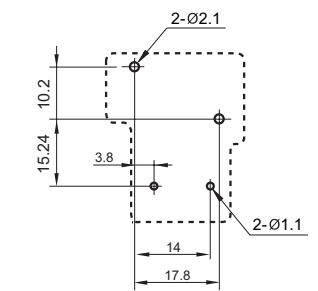
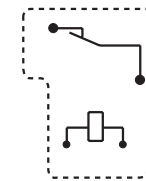
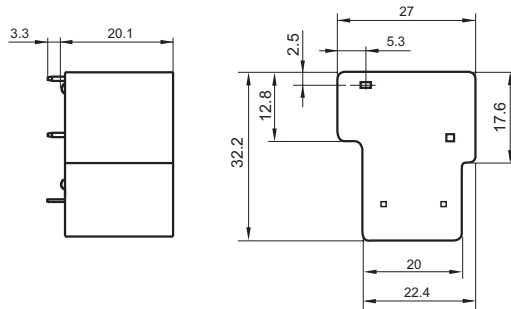

OUTLINE DIMENSIONS, WIRING DIAGRAM AND PC BOARD LAYOUT

Unit: mm

1 Form C

Outline Dimensions

Wiring Diagram (Bottom view)

PCB Layout (Bottom view)

With 6# terminal

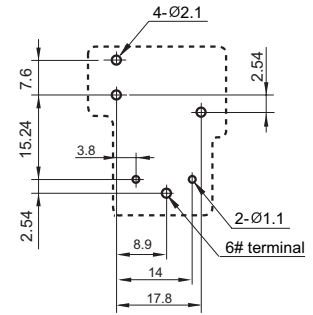
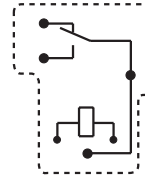
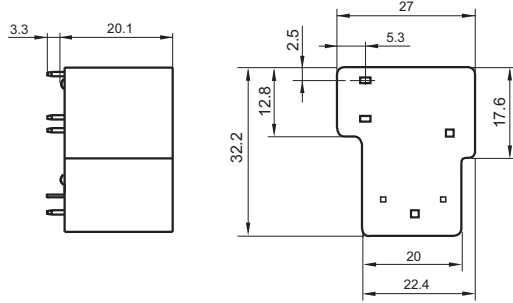

Without 6# terminal

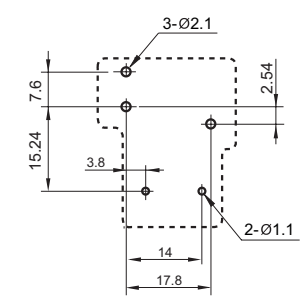
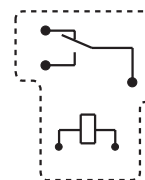
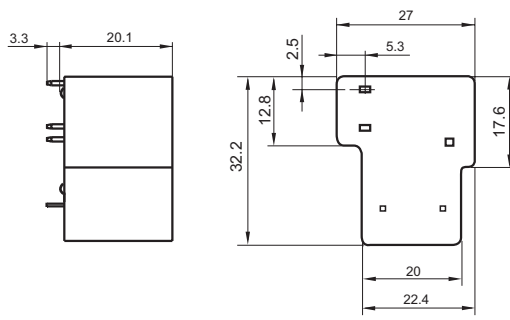

HF105-1

1 Form A

With 6# terminal

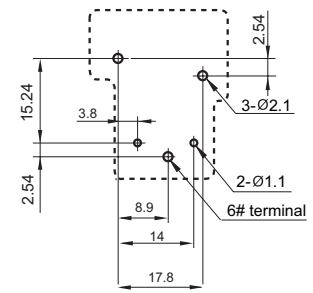
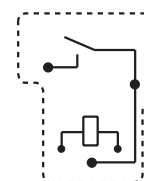
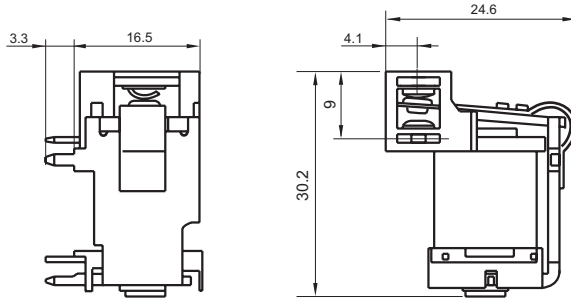

Without 6# terminal

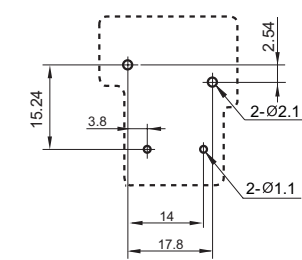
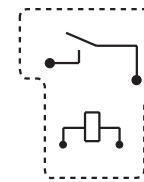
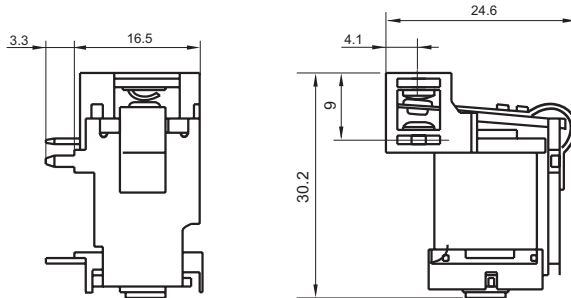

OUTLINE DIMENSIONS, WIRING DIAGRAM AND PC BOARD LAYOUT

Unit: mm

1 Form B

Outline Dimensions

With 6# terminal

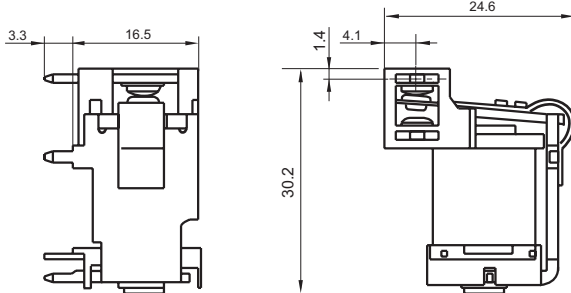

Wiring Diagram (Bottom view)

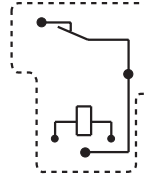

PCB Layout (Bottom view)

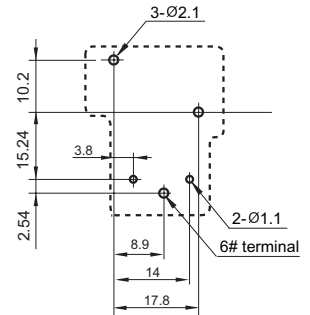

Without 6# terminal

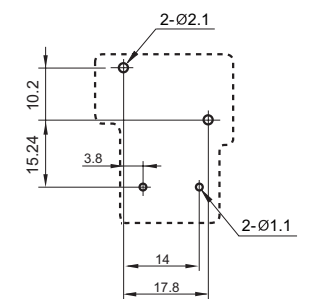
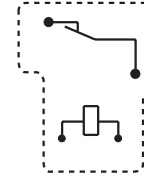
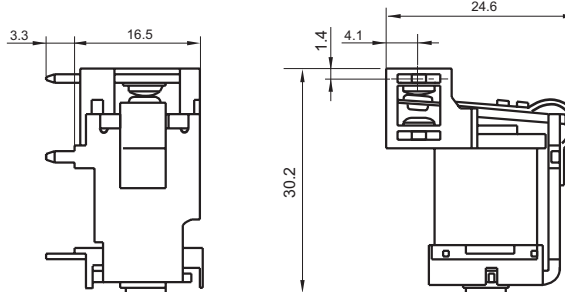

1 Form C

With 6# terminal

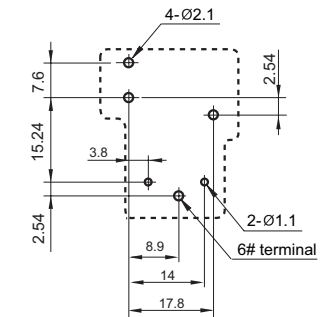
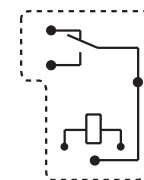
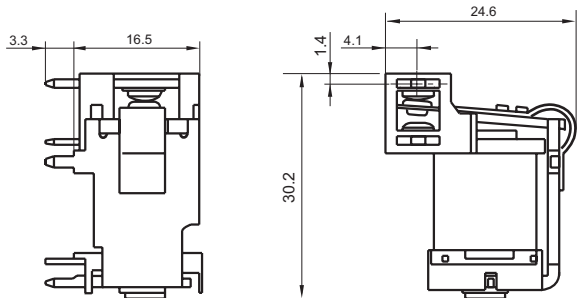

Without 6# terminal

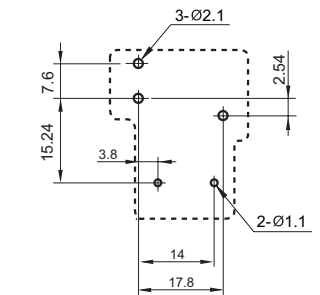
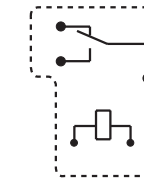
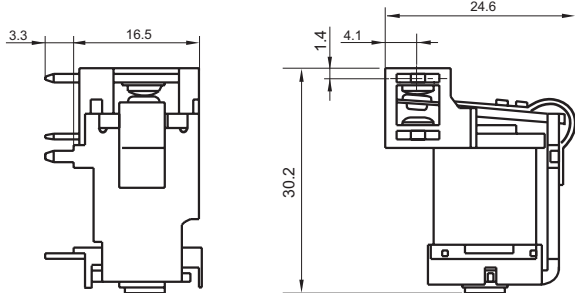

Remark: 1) In case of no tolerance shown in outline dimension: outline dimension $\leq 1\text{mm}$, tolerance should be $\pm 0.2\text{mm}$; outline dimension $> 1\text{mm}$ and $\leq 5\text{mm}$, tolerance should be $\pm 0.3\text{mm}$; outline dimension $> 5\text{mm}$, tolerance should be $\pm 0.4\text{mm}$.
2) The tolerance without indicating for PCB layout is always $\pm 0.1\text{mm}$.

CHARACTERISTIC CURVES

COIL TEMPERATURE RISE

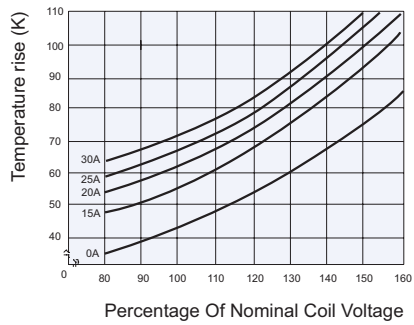

MAXIMUM SWITCHING POWER

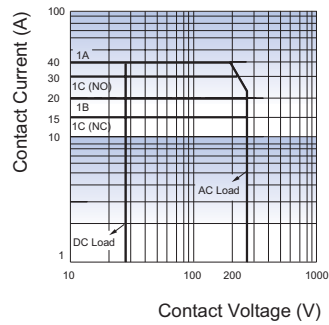

ENDURANCE CURVE

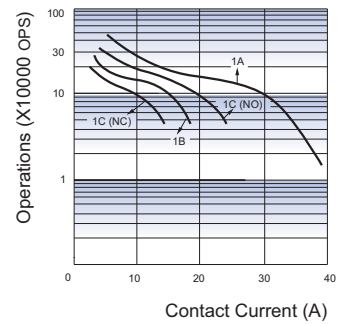

Disclaimer

This datasheet is for the customers' reference. All the specifications are subject to change without notice.

We could not evaluate all the performance and all the parameters for every possible application. Thus the user should be in a right position to choose the suitable product for their own application. If there is any query, please contact Hongfa for the technical service. However, it is the user's responsibility to determine which product should be used only.