

SPECIFICATION

Part No. : **GW26.0151**

Product Name : 2.4GHz Miniature Screw mount Monopole Antenna

Feature : RP-SMA(M) Connector
IP65
Peak Gain Max 1.8dBi
Height 30.3mm Diameter 7.9mm
ROHS Compliant



1 Introduction

The GW.26 2.4 GHz Monopole RP-SMA(M) mount antenna is ideal for 2.4 GHz wireless applications such as Bluetooth and Wireless LAN. Connector mount is fully customizable.

2 Specification

Wi-Fi 2.4GHz	
Frequency	2400~2500MHz
Bandwidth	1000MHz
Peak Gain	Max 1.8dBi
Radiation Efficiency	> 40%
Radiation	Omni-directional
Polarization	Vertical
Power Handling 1W Max	Power Handling 1W Max
Electrical Wave	1/2 Monopole
Impedance	50Ω
Operating Temperature	-40°C ~ +85°C
Storage Temperature	-40°C ~ +85°C

3 Mechanical Properties

Mechanical Properties	
Colour	Black and Green
IP rating	IP-65
Connector	RP-SMA(M)

4 Antenna Characteristics

4.1 Antenna S11

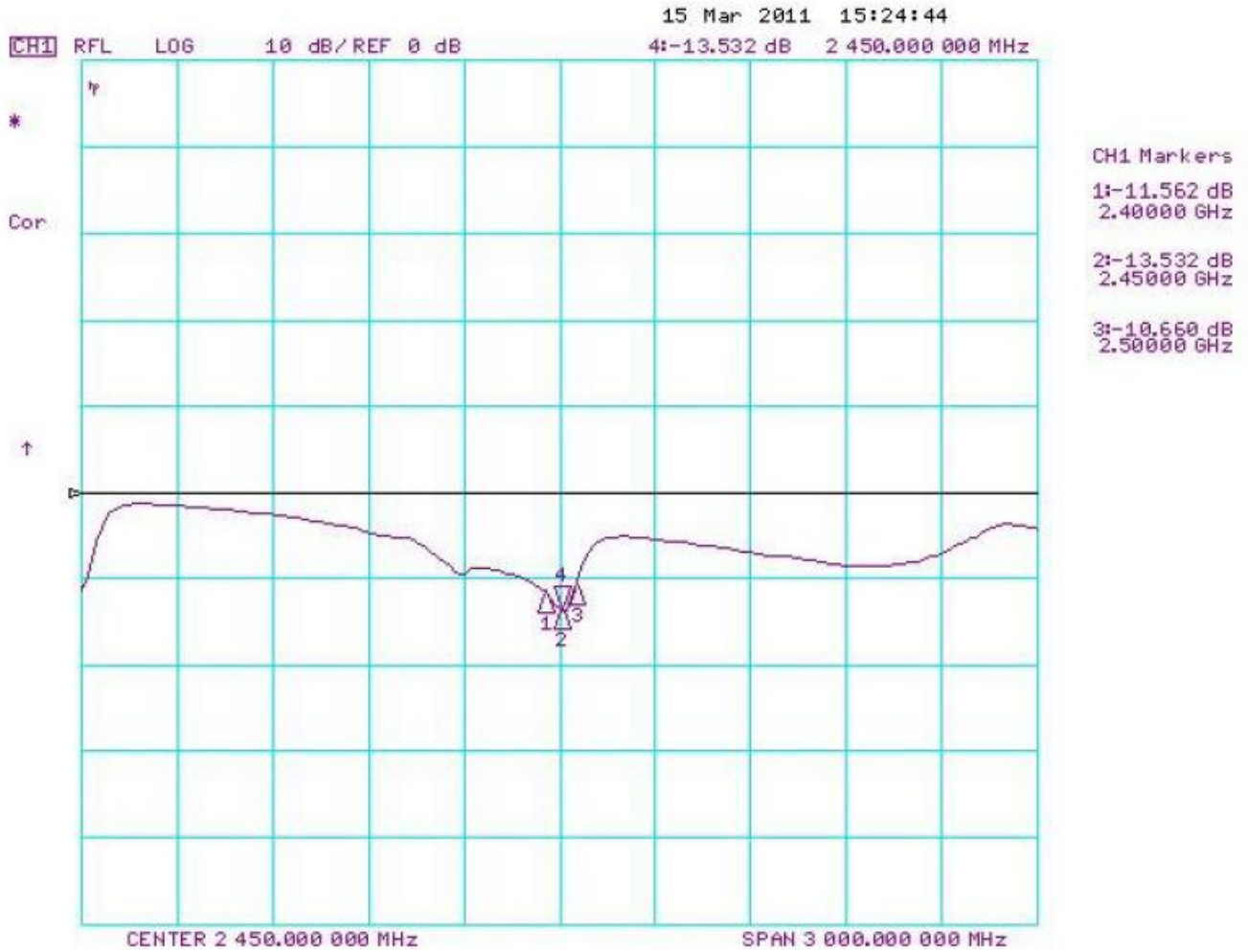

4.2 Antenna Peak Gain

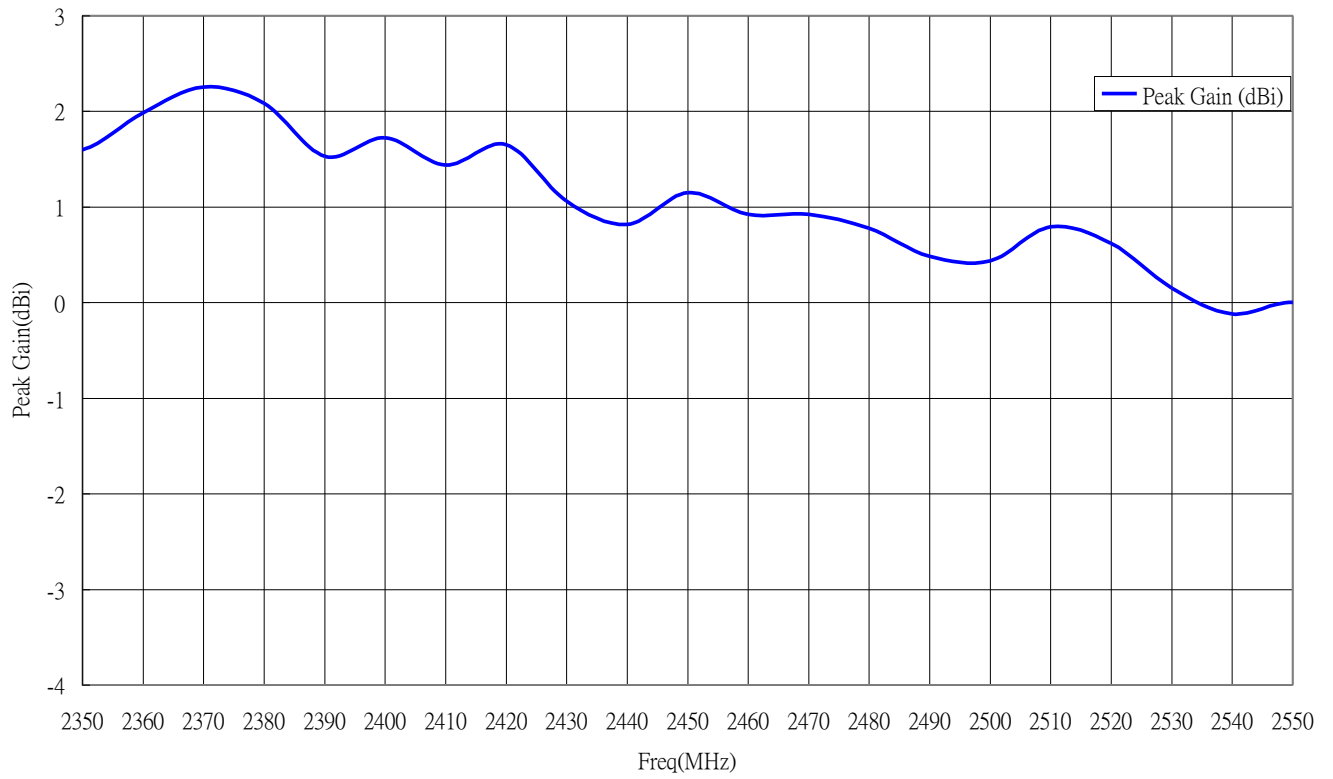

4.3 Antenna Efficiency

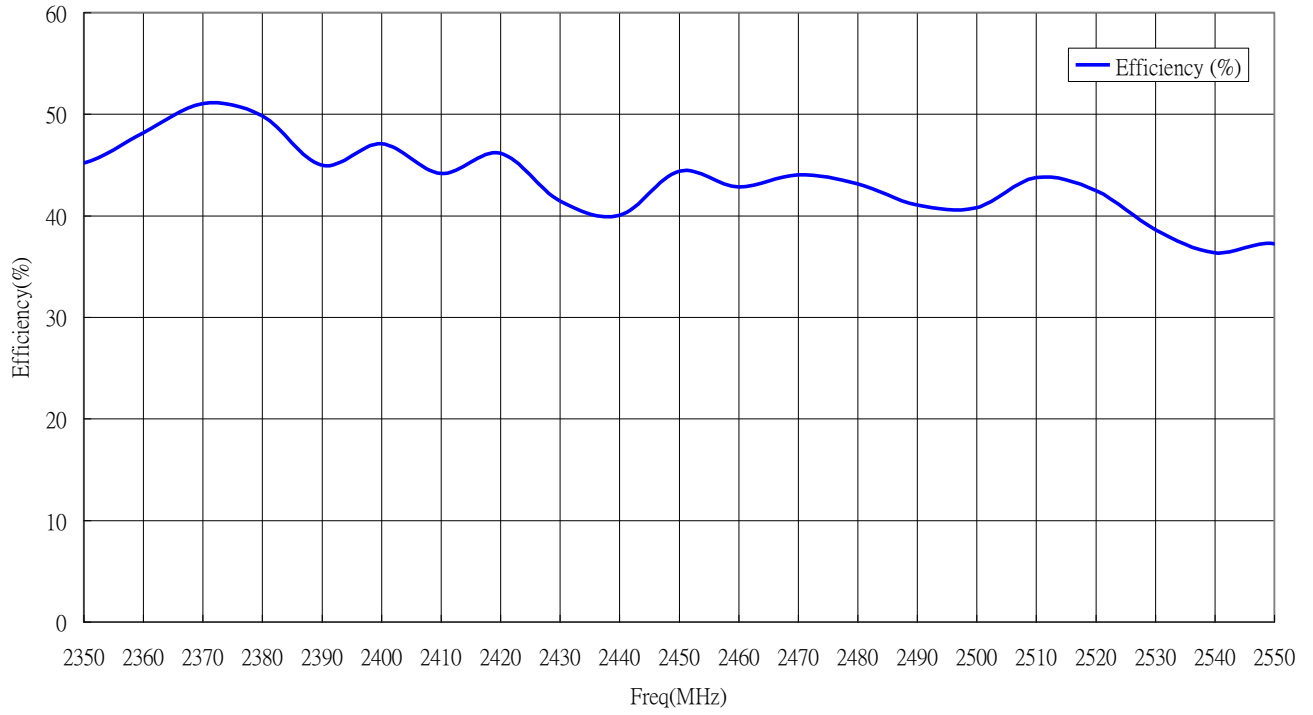

4.4 Antenna pattern (XY plane)

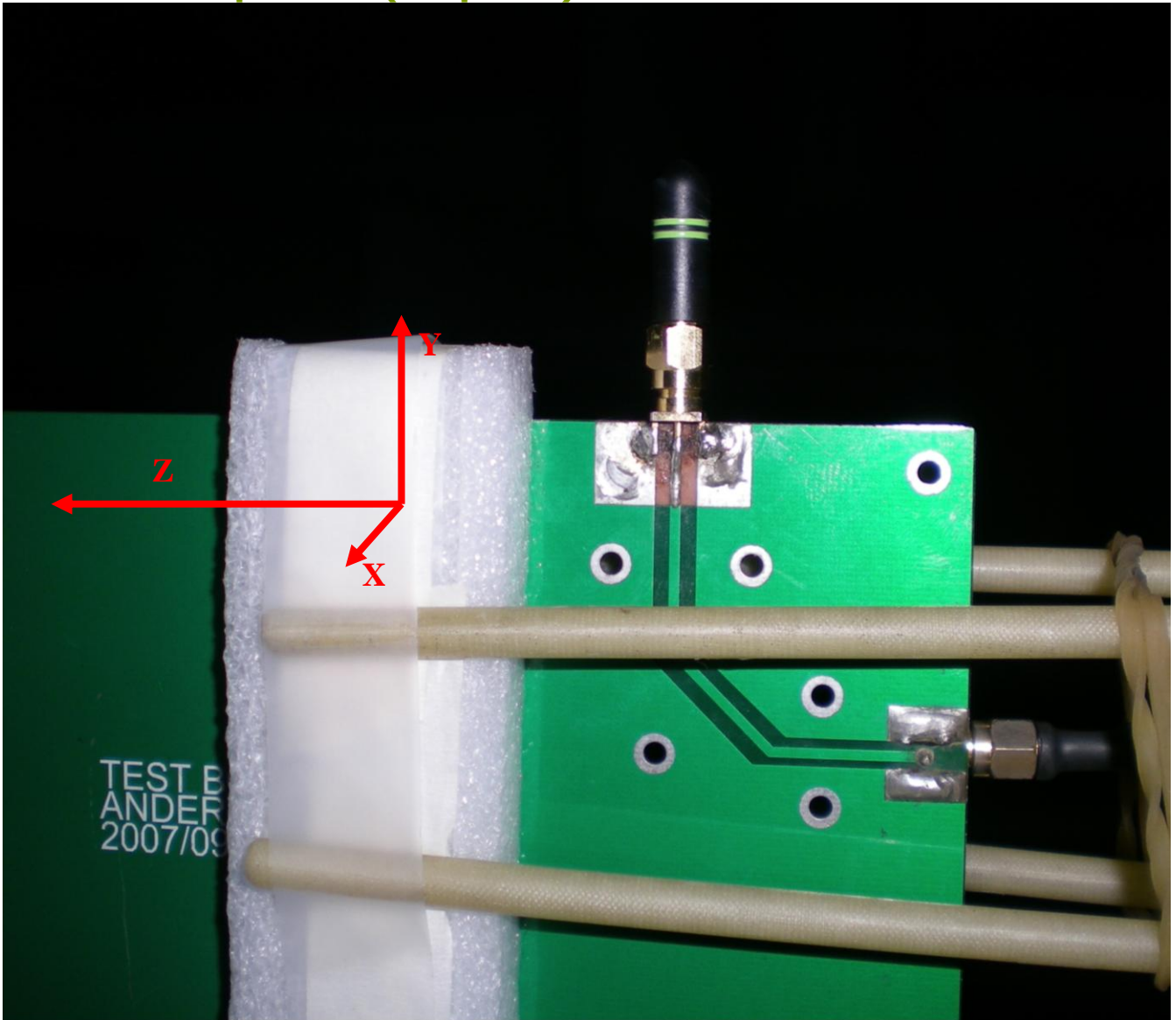

4.5 Antenna pattern (XY plane)

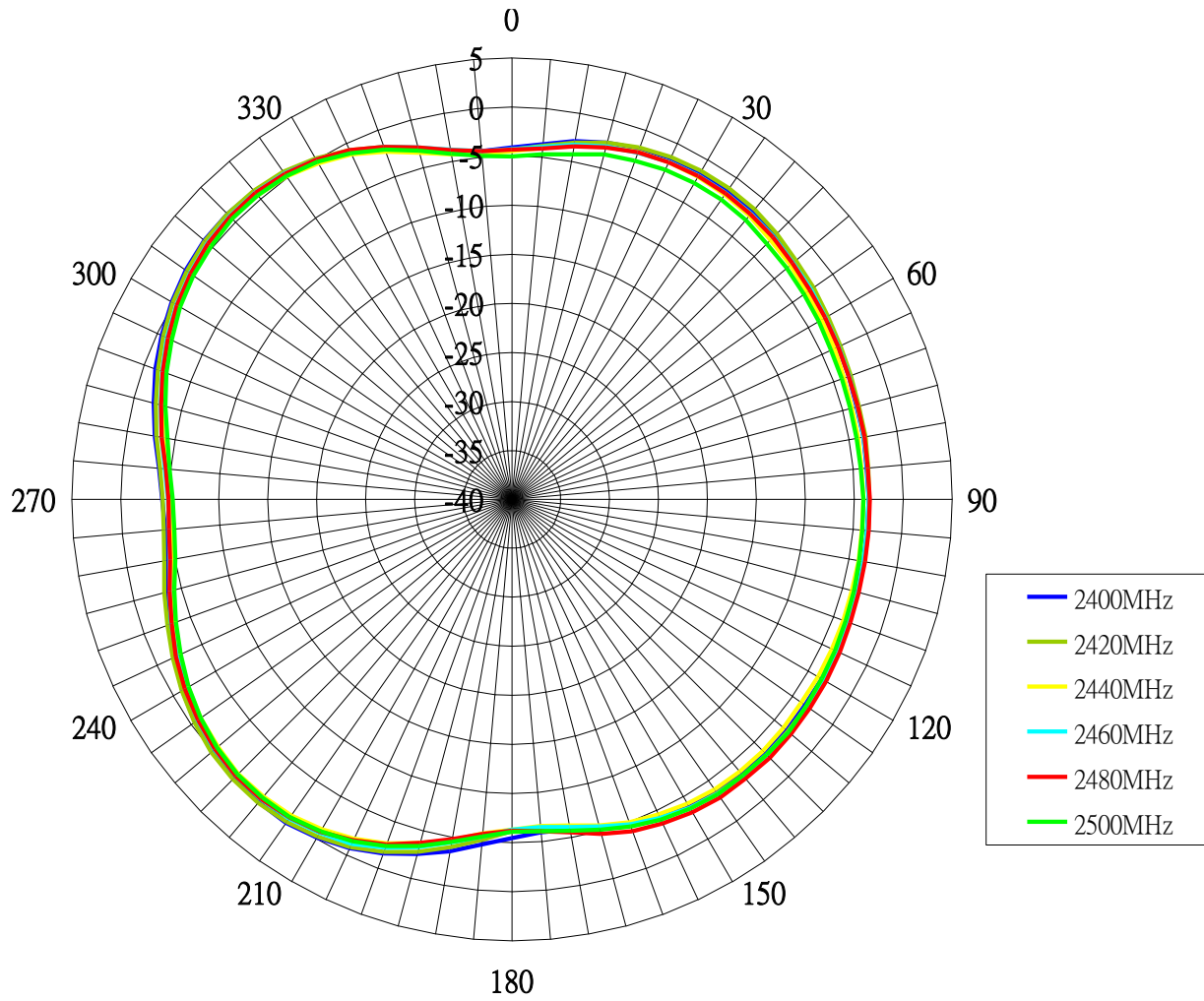

4.6 Antenna pattern (XZ plane)

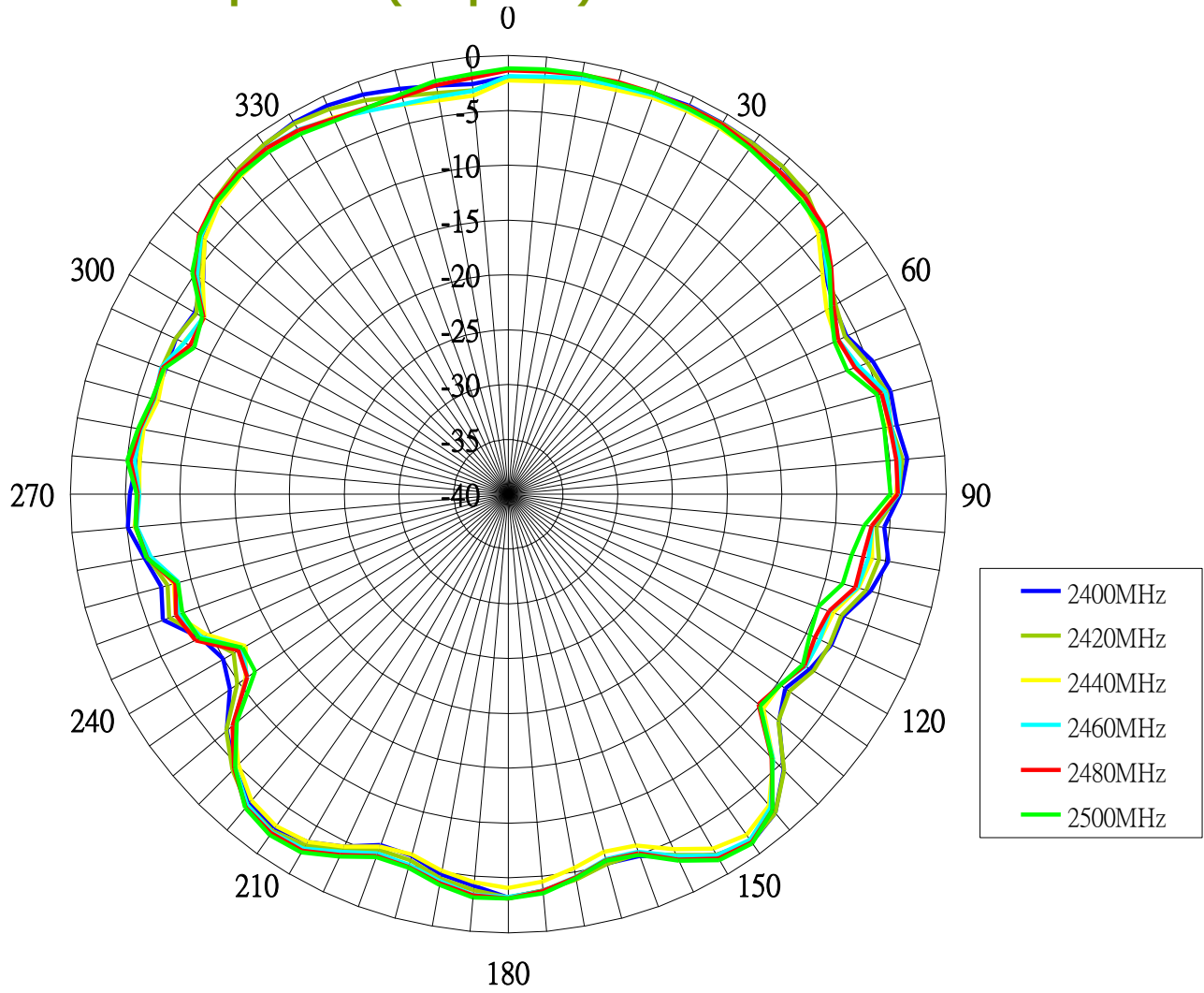

4.7 Antenna pattern (YZ plane)

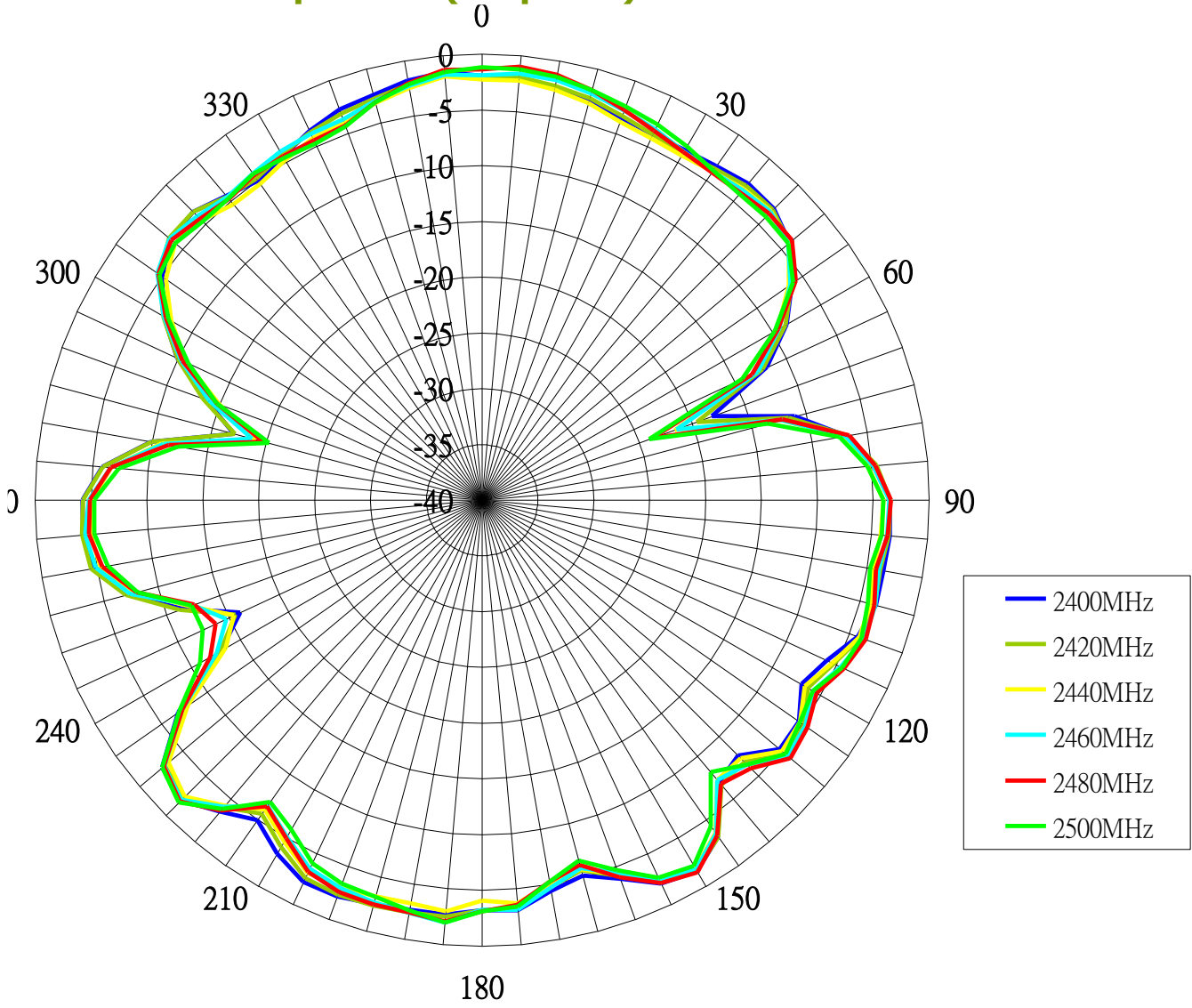

5. Outline Drawings and Structure

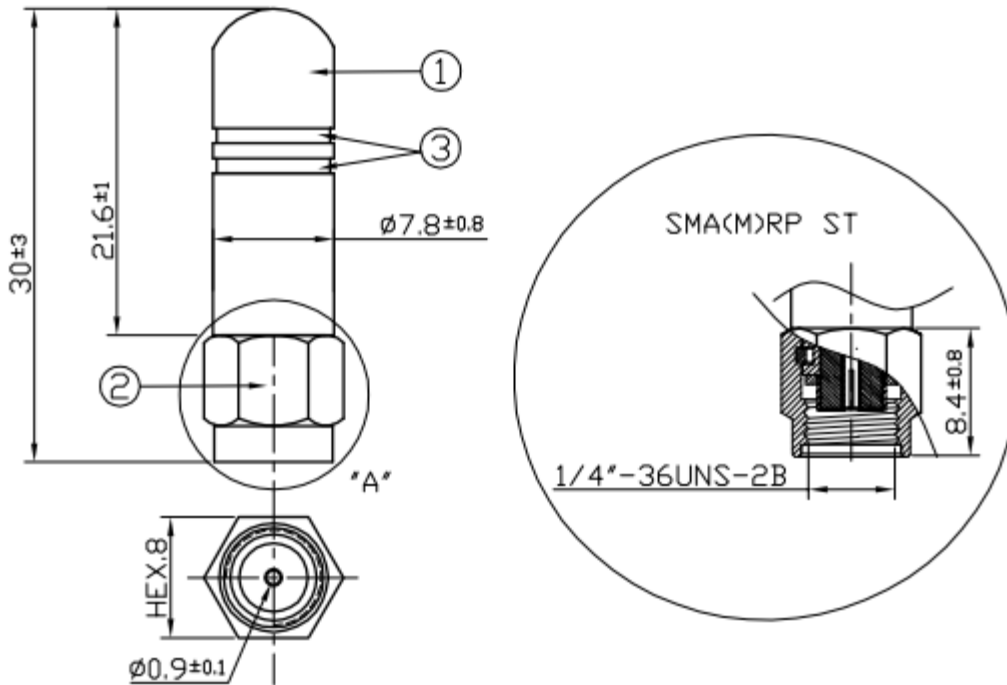

	Name	Material	Finish	QTY
①	Antenna Housing	TPEE	Black	1
②	SMA(M)RP ST	Brass	Gold	1
③	Colour Stripes	Acrylic Paint	Green	1

Mouser Electronics

Authorized Distributor

Click to View Pricing, Inventory, Delivery & Lifecycle Information:

[Taoglas:](#)

[GW.26.0151](#)