

PROTECTION PRODUCTS - RailClamp®

Description

RailClamp is an ultra low capacitance Transient Voltage Suppressor (TVS) designed to protect high speed data interfaces. This device has been specifically designed to protect sensitive components which are connected to high-speed data and transmission lines from over-voltage caused by **ESD** (electrostatic discharge), **CDE** (Cable Discharge Events), and **EFT** (electrical fast transients).

The RClamp™0531TQ has a maximum capacitance of only 0.80pF. This allows it to be used on circuits operating in excess of 2.5GHz without signal attenuation. They may be used to meet the ESD immunity requirements of IEC 61000-4-2.

The RClamp0531TQ is in a 2-pin SLP1006P2T package measuring 1.0 x 0.6 x 0.4mm. The leads are spaced at a pitch of 0.65mm and feature a lead-free finish. Each device will protect one high-speed line operating at 5 volts. It gives the designer the flexibility to protect single lines in applications where arrays are not practical. The combination of small size, low capacitance, and high ESD surge capability makes them ideal for use in applications such as cellular phones and digital video interfaces.

The RClamp0531TQ is AEC-Q100 Grade 1 qualified for Automotive use.

Package Dimensions

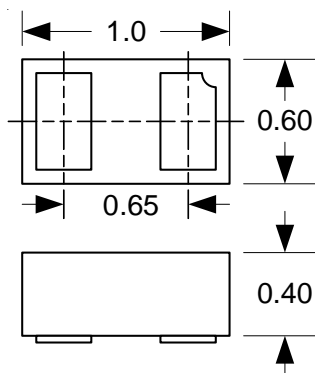

Maximum Dimensions (mm)

Features

- ◆ Transient protection for data lines to **IEC 61000-4-2 (ESD) ±20kV (air), ±12kV (contact)**
IEC 61000-4-4 (EFT) 40A (tp = 5/50ns)
Cable Discharge Event (CDE)
- ◆ Ultra-small package (1.0 x 0.6 x 0.4mm)
- ◆ Protects one I/O line
- ◆ Low capacitance: **0.8pF**
- ◆ Low clamping voltage
- ◆ Solid-state silicon-avalanche technology
- ◆ AEC-Q100 Grade 1 qualified.

Mechanical Characteristics

- ◆ SLP1006P2T package
- ◆ Molding compound flammability rating: UL 94V-0
- ◆ Marking: Marking code + date code
- ◆ Packaging : Tape and Reel
- ◆ Lead Finish: NiPdAu
- ◆ Pb-Free, Halogen Free, RoHS/WEEE Compliant

Applications

- ◆ Cellular Handsets & Accessories
- ◆ Digital Visual Interface (DVI)
- ◆ FM Antenna
- ◆ MDDI Ports
- ◆ USB Ports
- ◆ PCI Express
- ◆ Serial ATA
- ◆ Automotive Applications

Schematic & Pin Configuration

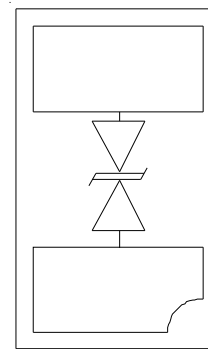

SLP1006P2T (Bottom View)

PROTECTION PRODUCTS
Absolute Maximum Ratings

Rating	Symbol	Value	Units
Peak Pulse Power (tp = 8/20μs)	P_{pk}	80	Watts
Peak Pulse Current (tp = 8/20μs)	I_{PP}	4	A
ESD per IEC 61000-4-2 (Air) ESD per IEC 61000-4-2 (Contact)	V_{ESD}	+/- 20 +/- 12	kV
Operating Temperature	T_J	-40 to +125	°C
Storage Temperature	T_{STG}	-55 to +150	°C

Electrical Characteristics (T=25°C unless otherwise specified)

Parameter	Symbol	Conditions	Minimum	Typical	Maximum	Units
Reverse Stand-Off Voltage	V_{RWM}				5	V
Reverse Breakdown Voltage	V_{BR}	$I_t = 1mA$	6	9.3	11	V
Reverse Leakage Current	I_R	$V_{RWM} = 5V, T=25^\circ C$		0.010	0.100	μA
		$V_{RWM} = 5V, T=125^\circ C$		0.020	0.200	
Clamping Voltage	V_C	$I_{PP} = 1A, tp = 8/20\mu s$			12	V
Clamping Voltage	V_C	$I_{PP} = 4A, tp = 8/20\mu s$			20	V
Junction Capacitance	C_J	$V_R = 0V, f = 1MHz, T=25^\circ C$		0.50	0.80	pF
		$V_R = 0V, f = 1MHz, T=125^\circ C$		0.85	1.5	

PROTECTION PRODUCTS

Typical Characteristics

Non-Repetitive Peak Pulse Power vs. Pulse Time

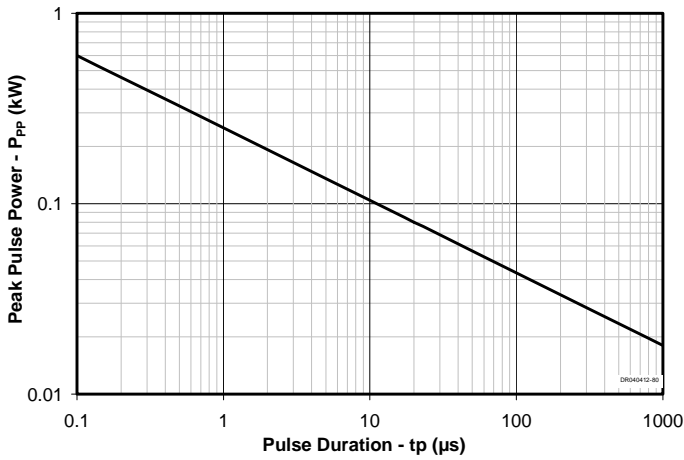

Power Derating Curve

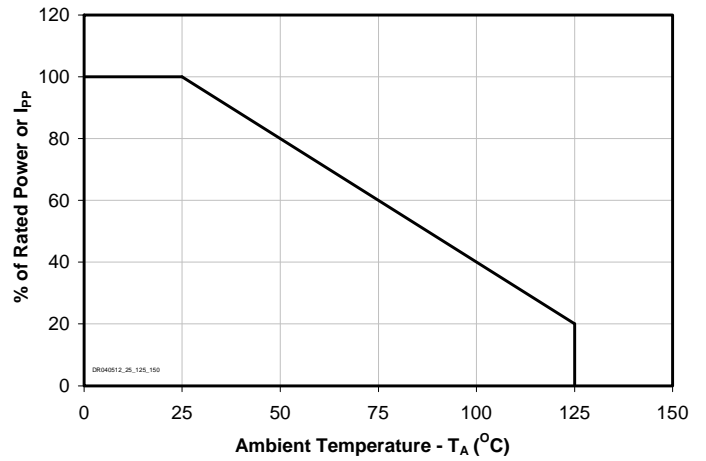

Clamping Voltage vs. Peak Pulse Current

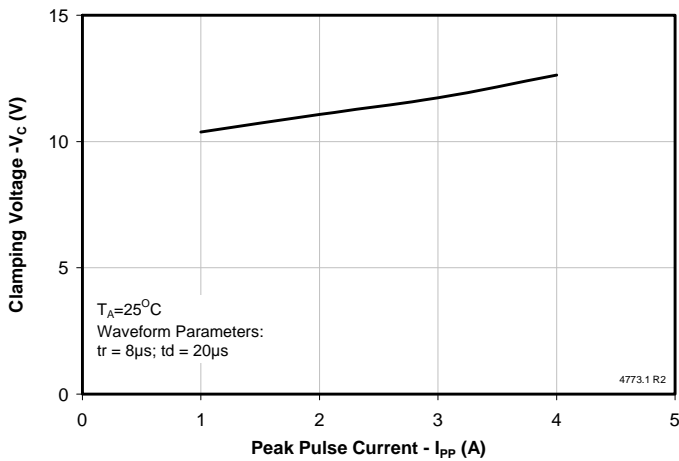

Typical Capacitance vs. Reverse Voltage

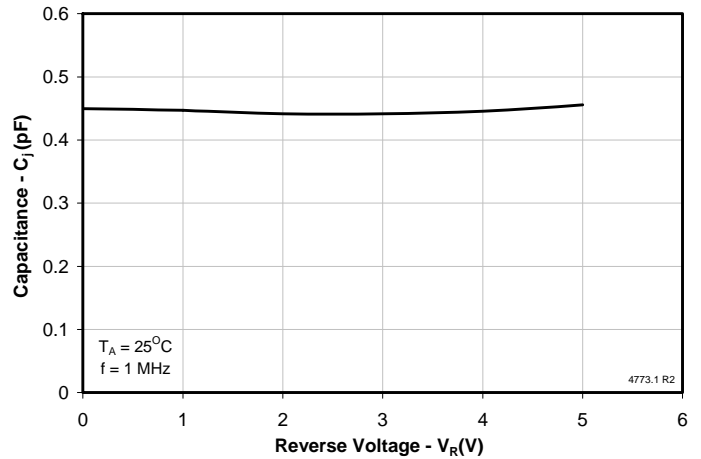

Insertion Loss S21

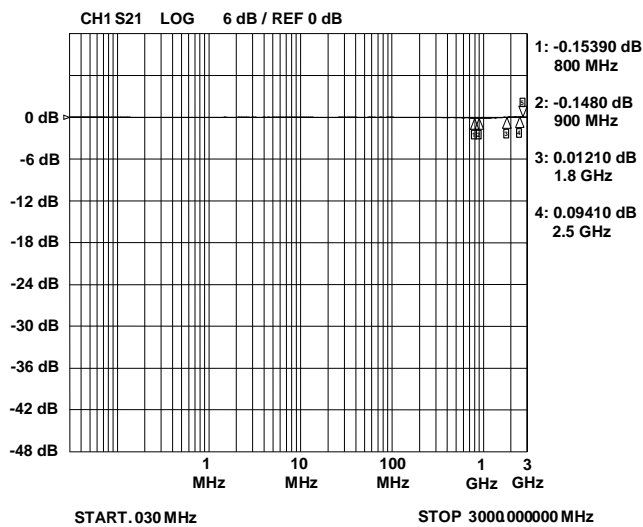

USB 2.0 Eye Pattern with RClamp0531TQ

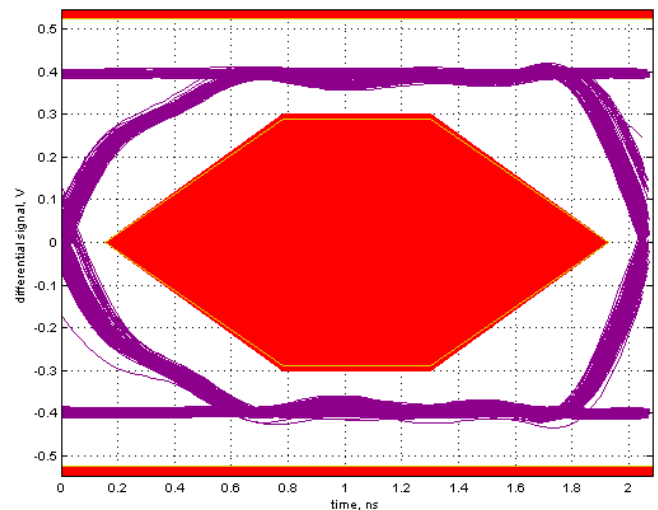

ESD Clamping per IEC 61000-4-2
Positive clamping voltage at first peak

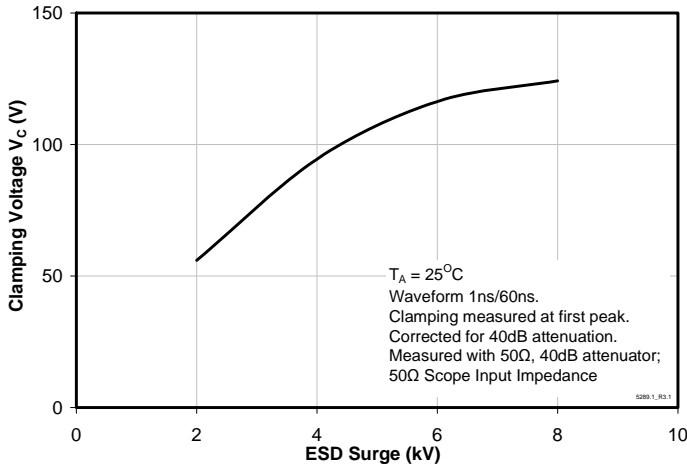

ESD Clamping per IEC 61000-4-2
Negative clamping voltage at first peak

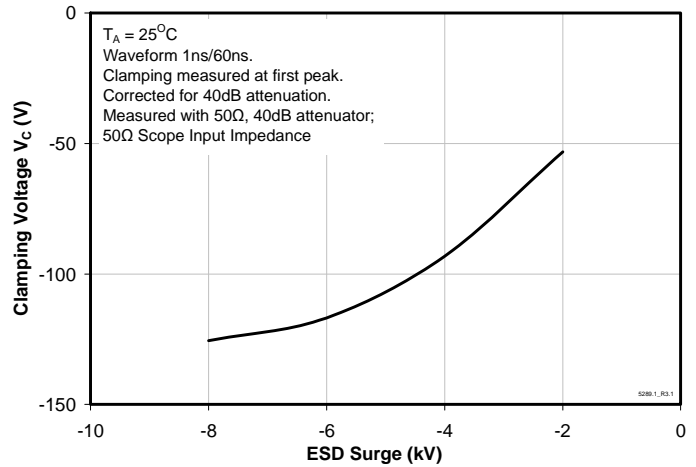

ESD Clamping per IEC 61000-4-2
Positive clamping voltage at 30ns

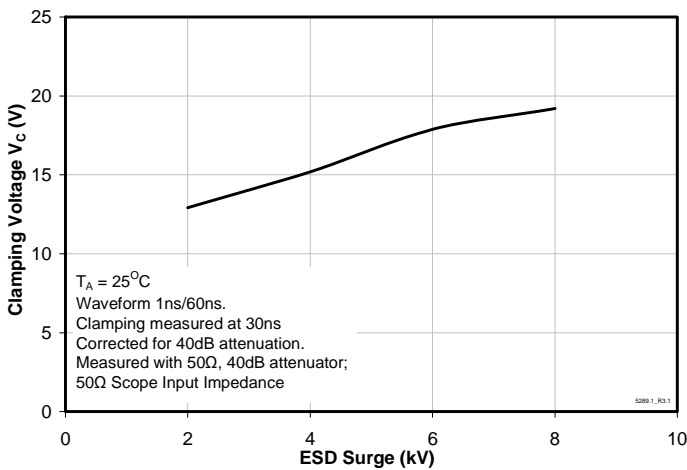

ESD Clamping per IEC 61000-4-2
Negative clamping voltage at 30ns

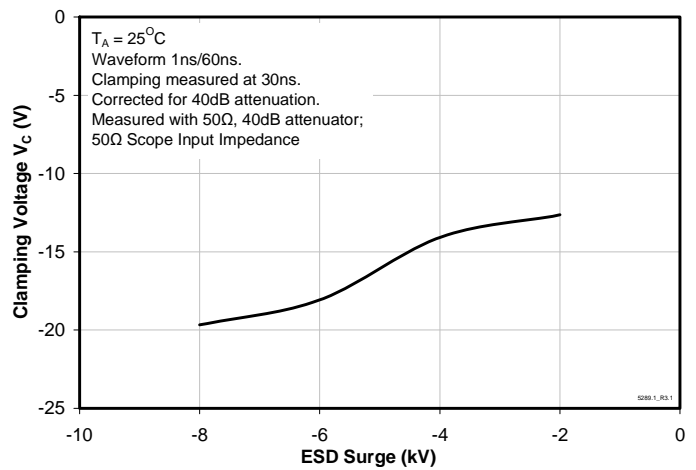

Typical TLP Characteristics

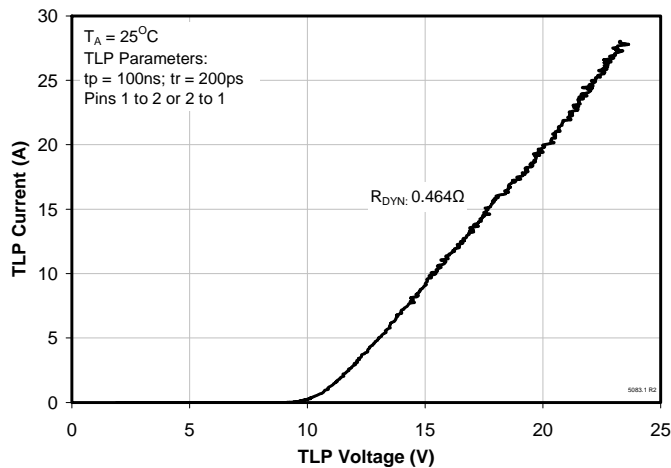

PROTECTION PRODUCTS

Typical Characteristics

Typical Capacitance v Temperature

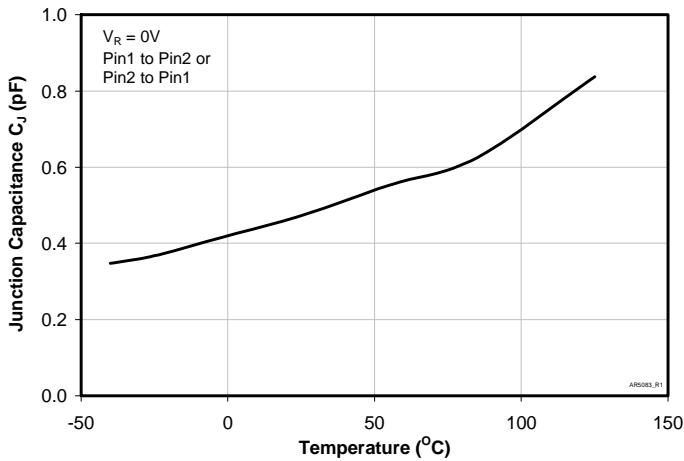

Typical Breakdown Voltage v Temperature

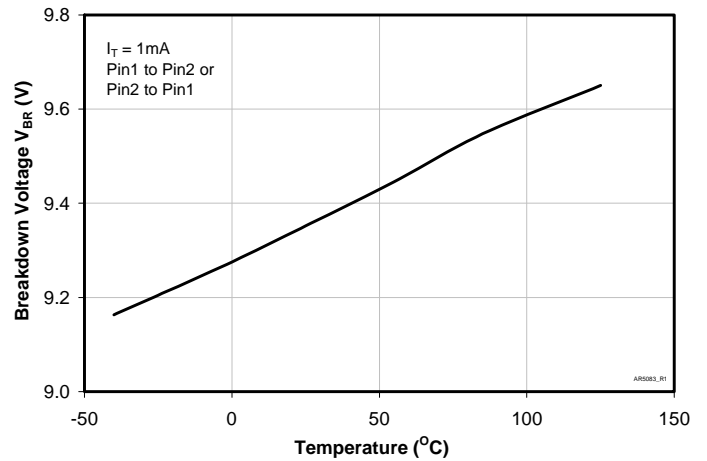

Typical Leakage Current v Temperature

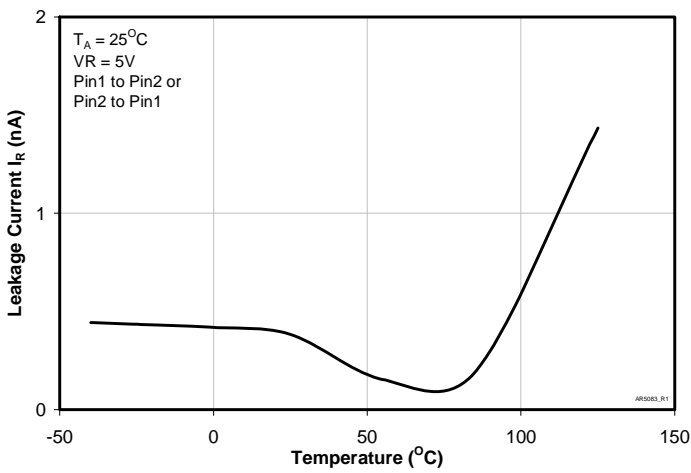

Typical Leakage Current v Reverse Voltage

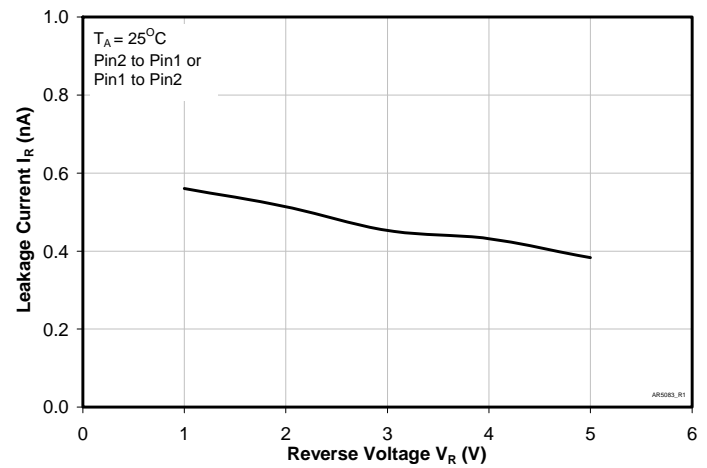

PROTECTION PRODUCTS**Applications Information****Device Connection Options**

These low capacitance TVS diodes are designed to provide common mode protection for one high-speed line or differential protection for one line pair. The device is bidirectional and may be used on lines where the signal polarity is positive and negative.

Circuit Board Layout Recommendations for Suppression of ESD.

Good circuit board layout is critical for the suppression of ESD induced transients. The following guidelines are recommended:

- Place the TVS near the input terminals or connectors to restrict transient coupling.
- Minimize the path length between the TVS and the protected line.
- Minimize all conductive loops including power and ground loops.
- The ESD transient return path to ground should be kept as short as possible.
- Never run critical signals near board edges.
- Use ground planes whenever possible.

Equivalent Circuit Diagram

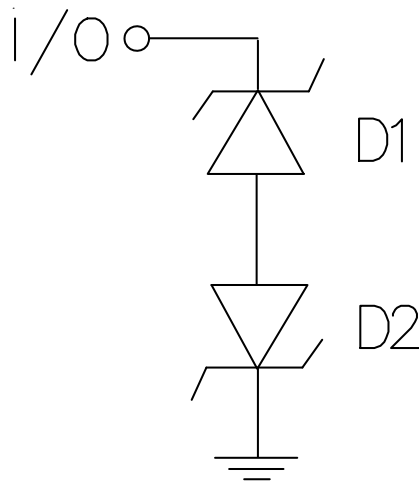

RClamp0531TQ Spice Model

RClamp0531TQ Spice Parameters			
Parameter	Unit	D1 (TVS)	D2 (TVS)
IS	Amp	2.11E-14	2.11E-14
BV	Volt	8.6	8.6
VJ	Volt	0.7	0.7
RS	Ohm	0.4	0.4
IBV	Amp	1E-3	1E-3
CJO	Farad	0.8E-12	0.8E-12
TT	sec	2.541E-9	2.541E-9
M	--	0.02	0.02
N	--	1.1	1.1
EG	eV	1.11	1.11

Note: Spice model is for simulating transient response only.

PROTECTION PRODUCTS

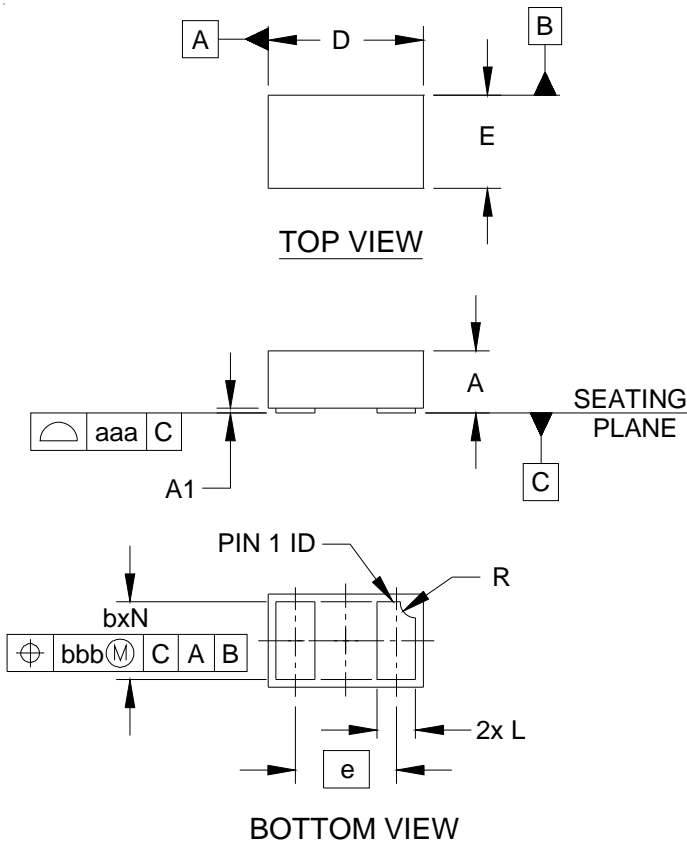
Outline Drawing - SLP1006P2T



DIM	INCHES			MILLIMETERS		
	MIN	NOM	MAX	MIN	NOM	MAX
A	.015	.016	.017	0.37	0.40	0.43
A1	.000	.001	.002	0.00	0.03	0.05
b	.018	.020	.022	0.45	0.50	0.55
D	.035	.039	.043	0.90	1.00	1.10
E	.020	.024	.028	0.50	0.60	0.70
e	.026 BSC			0.65 BSC		
L	.008	.010	.012	0.20	0.25	0.30
R	.002	.004	.006	0.05	0.10	0.15
N	2			2		
aaa	.003			0.08		
bbb	.004			0.10		

NOTES:

1. CONTROLLING DIMENSIONS ARE IN MILLIMETERS (ANGLES IN DEGREES).

Land Pattern - SLP1006P2T

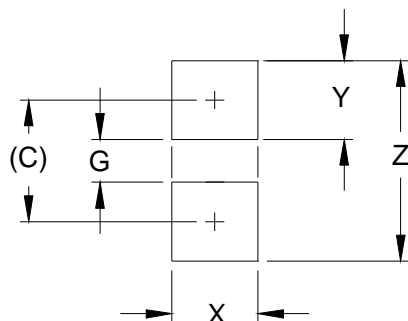

DIM	DIMENSIONS	
	INCHES	MILLIMETERS
C	(.033)	(0.85)
G	.012	0.30
X	.024	0.60
Y	.022	0.55
Z	.055	1.40

NOTES:

1. CONTROLLING DIMENSIONS ARE IN MILLIMETERS (ANGLES IN DEGREES).
2. THIS LAND PATTERN IS FOR REFERENCE PURPOSES ONLY.
CONSULT YOUR MANUFACTURING GROUP TO ENSURE YOUR COMPANY'S MANUFACTURING GUIDELINES ARE MET.

PROTECTION PRODUCTS

Marking

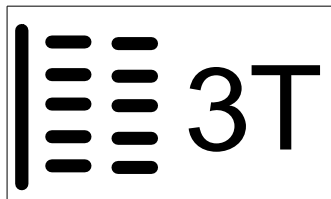

Notes:

- 1) Marking will also include line matrix date code
- 2) Device is electrically symmetrical

Ordering Information

Part Number	Working Voltage	Qty per Reel	Reel Size
RClamp0531TQTCT	5V	3,000	7 Inch

Note: Lead finish is lead-free NiPdAu.

RailClamp and RClamp are marks of Semtech Corporation.

Tape and Reel Specification

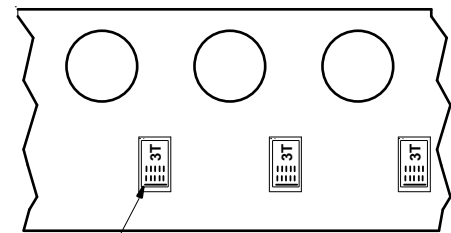
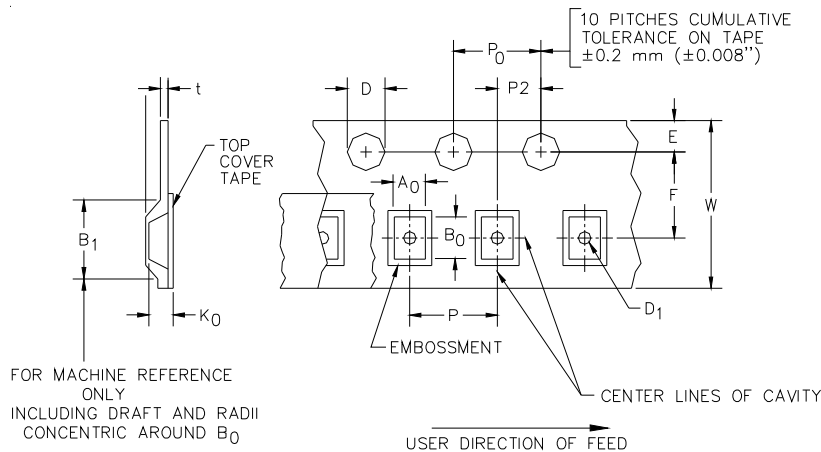

Band Location
(Opposite Sprocket Holes)

Device Orientation in Tape

A0	B0	K0
0.69 +/-0.10 mm	1.19 +/-0.10 mm	0.66 +/-0.10 mm

Tape Width	B, (Max)	D	D1	E	F	K (Max)	P	P0	P2	T (Max)	W
8 mm	4.2 mm (.165)	1.5 + 0.1 mm - 0.0 mm (0.59 +.005 - .000)	0.8 mm ±0.25 (.031)	1.750±0.1 mm (.069±.004)	3.5±0.05 mm (.138±.002)	2.4 mm (.094)	4.0±0.10 mm (.157±.004)	4.0±0.1 mm (.157±.004)	2.0±0.05 mm (.079±.002)	0.4mm (.016)	8.0 mm + 0.3 mm - 0.1 mm (.312±.012)

Contact Information

Semtech Corporation
 Protection Products Division
 200 Flynn Rd., Camarillo, CA 93012
 Phone: (805)498-2111 FAX (805)498-3804