

Photologic[®] Sensors

Types OPL560, OPL561, OPL562, OPL563 Series

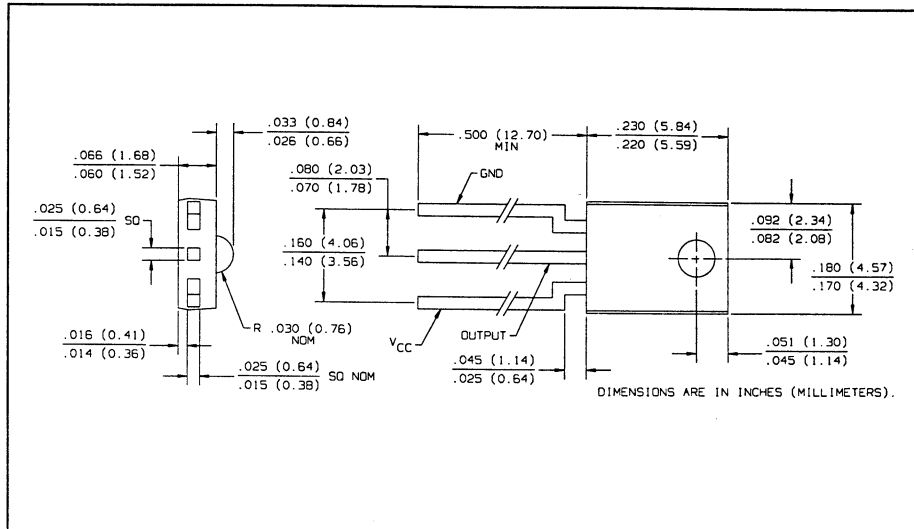
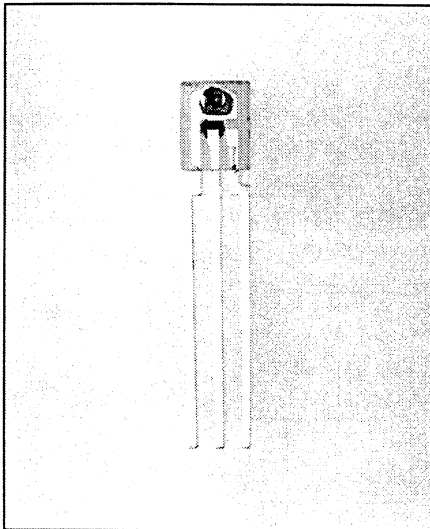

Features

- Four output options
- High noise immunity
- Direct TTL/LSTTL interface
- Low cost plastic side-looking package
- Mechanically and spectrally matched to the OP140 and OP240 series LED's
- Data rates to 200 kBaud
- Two sensitivity options

Description

The OPL560, OPL560-OC, OPL561, OPL561-OC, OPL562, OPL562-OC, OPL563, and OPL563-OC contain a monolithic integrated circuit which incorporates a photodiode, a linear amplifier, voltage regulator, and a Schmitt trigger on a single silicon chip. The devices feature TTL/LSTTL compatible logic level output which can drive up to 10 TTL loads over supply voltages ranging from 4.5 V to 16 V. The Photologic[®] chip is encapsulated in a molded plastic package which has an integral lens for enhanced optical coupling.

Absolute Maximum Ratings (T_A = 25° C unless otherwise noted)

Supply Voltage, V _{CC}	18 V
Storage Temperature Range	-40° C to +100° C
Operating Temperature Range	-40° C to +85° C
Lead Soldering Temperature Range [1/16 inch (1.6 mm) from case for 5 sec. with soldering iron]	240° C
Power Dissipation	200 mW ⁽¹⁾
Duration of Output Short to V _{CC} (OPL560, OPL561, OPL562, OPL563)	1.00 sec.
Duration of Output Short to V _{CC} (OPL560-OC, OPL561-OC, OPL562-OC, OPL563-OC)	1.00 sec.
Voltage at Output Lead (OPL560-OC, OPL561-OC, OPL562-OC, OPL563-OC)	35 V
Sinking Current	50 mA
Sourcing Current (OPL560, OPL561, OPL562, OPL563)	10 mA
Irradiance (OPL560, OPL560-OC, OPL561, OPL561-OC)	9 mW/cm ²
Irradiance (OPL562, OPL562-OC, OPL563, OPL563-OC)	3 mW/cm ²

Notes:

- (1) Derate linearly 2.50 mW/° C above 25° C.
- (2) RMA flux is recommended. Duration can be extended to 10 sec. maximum when flow soldering. Max 20 grams force may be applied to the leads when soldering.
- (3) Irradiance measurements are made with λ_i = 953 nm.

Schematics

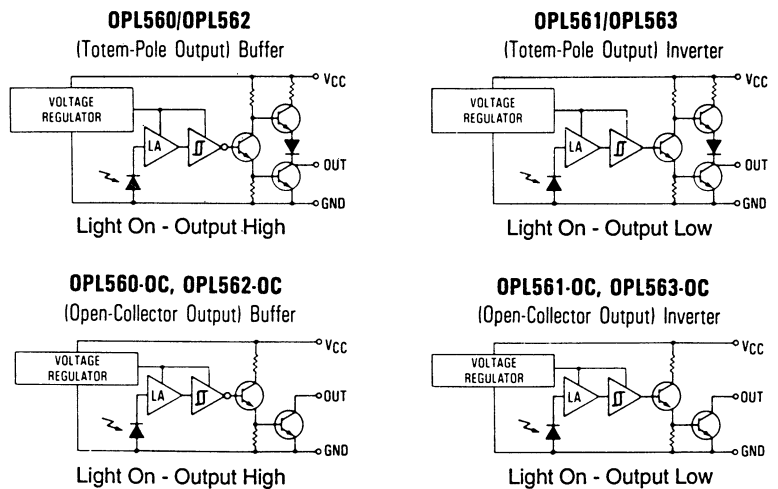

Types OPL560, OPL561 Series

Electrical Characteristics (-40° C to +85° C unless otherwise noted) $V_{CC} = 4.5 \text{ V to } 16 \text{ V}$

SYMBOL	PARAMETER	MIN	TYP	MAX	UNITS	TEST CONDITIONS
V_{CC}	Operating Supply Voltage	4.5		16.0	V	
	Peak-to-Peak V_{CC} Ripple Necessary to Cause False Triggering of Output			2	V	$f = \text{DC to } 50 \text{ MHz}$
$E_{eT(+)}$	Positive-Going Threshold Irradiance ⁽³⁾ OPL560, OPL560-OC, OPL561, OPL561-OC OPL560A, OPL560-OCA, OPL561A, OPL561-OCA	0.09 0.09		0.55 0.36	mW/cm^2 mW/cm^2	$T_A = 25^\circ \text{ C}$ $T_A = 25^\circ \text{ C}$
$E_{eT(+)} / E_{eT(-)}$	Hysteresis Ratio	1.20	1.55	2.00		
I_{CC}	Supply Current		8.0	12.0	mA	$E_e = 0 \text{ or } 1 \text{ mW/cm}^2$
OPL560 (Buffer, Totem-Pole)						
V_{OH}	High Level Output Voltage	$V_{CC}-2.1$			V	$I_{OH} = -1 \mu\text{A}$, $E_e = 1 \text{ mW/cm}^2$
V_{OL}	Low Level Output Voltage			0.40	V	$I_{OL} = 16 \text{ mA}$, $E_e = 0$
OPL560-OC (Buffer, Open-Collector)						
I_{OH}	High Level Output Current			100	μA	$V_{OH} = 30 \text{ V}$, $E_e = 1 \text{ mW/cm}^2$
V_{OL}	Low Level Output Voltage			0.40	V	$I_{OL} = 16 \text{ mA}$, $E_e = 0$
OPL561 (Inverter, Totem-Pole)						
V_{OH}	High Level Output Voltage	$V_{CC}-2.1$			V	$I_{OH} = -1 \text{ mA}$, $E_e = 0$
V_{OL}	Low Level Output Voltage			0.40	V	$I_{OL} = 16 \text{ mA}$, $E_e = 1 \text{ mW/cm}^2$
OPL561-OC (Inverter, Open-Collector)						
I_{OH}	High Level Output Current			100	μA	$V_{OH} = 30 \text{ V}$, $E_e = 0$
V_{OL}	Low Level Output Voltage			0.40	V	$I_{OL} = 16 \text{ mA}$, $E_e = 1 \text{ mW/cm}^2$
OPL560, OPL561						
t_r, t_f	Output Rise Time, Output Fall Time			70	ns	$T_A = 25^\circ \text{ C}$, $E_e = 0$ or 1 mW/cm^2 , $f = 10 \text{ kHz}$
t_{PHL}, t_{PLH}	Propagation Delay, Low-High, High-Low		5.0		μs	DC = 50%, $R_L = 10 \text{ TTL Loads}$
OPL560-OC, OPL561-OC						
t_r, t_f	Output Rise Time, Output Fall Time			100	ns	$T_A = 25^\circ \text{ C}$, $E_e = 0$ or 1 mW/cm^2 , $f = 10 \text{ kHz}$
t_{PLH}, t_{PLH}	Propagation Delay, Low-High, High-Low		5.0		μs	DC = 50%, $R_L = 300 \Omega$

PHOTOLOGIC
SENSORS

Typical Performance Curves

OPL560, OPL561, OPL562, OPL563
Output Voltage vs. Ambient Temp.

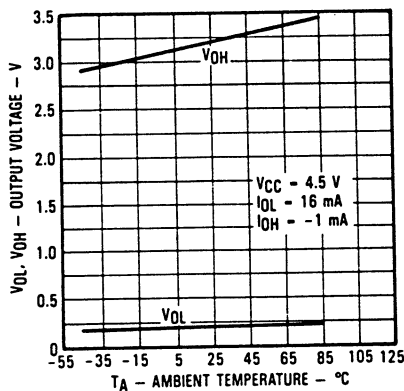

OPL560-OC, OPL561-OC, OPL562-OC, OPL563-OC
High Output Current vs. Ambient Temp.

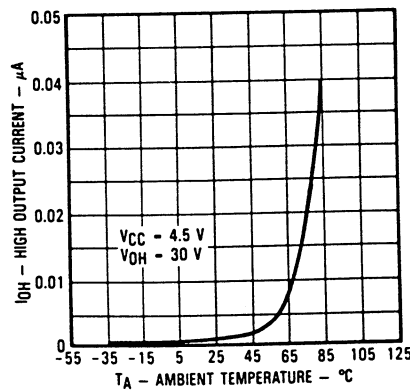

OPL560, OPL560-OC, OPL561, OPL561-OC
Normalized Threshold Irradiance vs. T_A

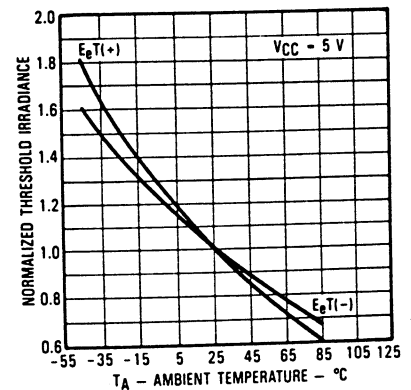

Optek reserves the right to make changes at any time in order to improve design and to supply the best product possible.
Optek Technology, Inc. 1215 W. Crosby Road Carrollton, Texas 75006 (972)323-2200 Fax (972)323-2396

Types OPL562, OPL563 Series



Electrical Characteristics (-40° C to +85° C unless otherwise noted) $V_{CC} = 4.5 \text{ V to } 16 \text{ V}$

SYMBOL	PARAMETER	MIN	TYP	MAX	UNITS	TEST CONDITIONS
V_{CC}	Operating Supply Voltage	4.5		16.0	V	
	Peak-to-Peak V_{CC} Ripple Necessary to Cause False Triggering of Output			2	V	$f = \text{DC to } 50 \text{ MHz}$
$E_{eT(+)}$	Positive-Going Threshold Irradiance ⁽³⁾ OPL562, OPL562-OC, OPL563, OPL563-OC OPL562A, OPL562-OCA, OPL563A, OPL563-OCA	0.025 0.025		0.230 0.140	mW/cm^2 mW/cm^2	$T_A = 25^\circ \text{ C}$ $T_A = 25^\circ \text{ C}$
$E_{eT(+)} / E_{eT(-)}$	Hysteresis Ratio	1.20	1.55	2.00		
I_{CC}	Supply Current		8.0	12.0	mA	$E_e = 0 \text{ or } 0.3 \text{ mW/cm}^2$
OPL562 (Buffer, Totem-Pole)						
V_{OH}	High Level Output Voltage	$V_{CC}-2.1$			V	$I_{OH} = -1 \mu\text{A}$, $E_e = 0.3 \text{ mW/cm}^2$
V_{OL}	Low Level Output Voltage			0.40	V	$I_{OL} = 16 \text{ mA}$, $E_e = 0$
OPL562-OC (Buffer, Open-Collector)						
I_{OH}	High Level Output Current			100	μA	$V_{OH} = 30 \text{ V}$, $E_e = 0.3 \text{ mW/cm}^2$
V_{OL}	Low Level Output Voltage			0.40	V	$I_{OL} = 16 \text{ mA}$, $E_e = 0$
OPL563 (Inverter, Totem-Pole)						
V_{OH}	High Level Output Voltage	$V_{CC}-2.1$			V	$I_{OH} = -1 \text{ mA}$, $E_e = 0$
V_{OL}	Low Level Output voltage			0.40	V	$I_{OL} = 16 \text{ mA}$, $E_e = 0.3 \text{ mW/cm}^2$
OPL563-OC (Inverter, Open-Collector)						
I_{OH}	High Level Output Current			100	μA	$V_{OH} = 30 \text{ V}$, $E_e = 0$
V_{OL}	Low Level Output Voltage			0.40	V	$I_{OL} = 16 \text{ mA}$, $E_e = 0.3 \text{ mW/cm}^2$
OPL562, OPL563						
t_r, t_f	Output Rise Time, Output Fall Time			70	ns	$T_A = 25^\circ \text{ C}$, $E_e = 0$ or 0.3 mW/cm^2 , $f = 10 \text{ kHz}$, DC = 50%, $R_L = 10 \text{ TTL Loads}$
t_{PLH}, t_{PHL}	Propagation Delay, Low-High, High-Low		6.0		μs	
OPL562-OC, OPL563-OC						
t_r, t_f	Output Rise Time, Output Fall Time			100	ns	$T_A = 25^\circ \text{ C}$, $E_e = 0$ or 0.3 mW/cm^2 , $f = 10 \text{ kHz}$, DC = 50%, $R_L = 300 \Omega$
t_{PLH}, t_{PHL}	Propagation Delay, Low-High, High-Low		6.0		μs	

Typical Performance Curves

OPL562, OPL562-OC, OPL563, OPL563-OC
Normalized Threshold Irradiance vs. Amb. Temp.

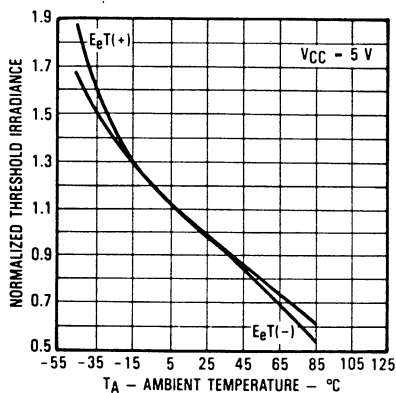

Normalized Spectral Response

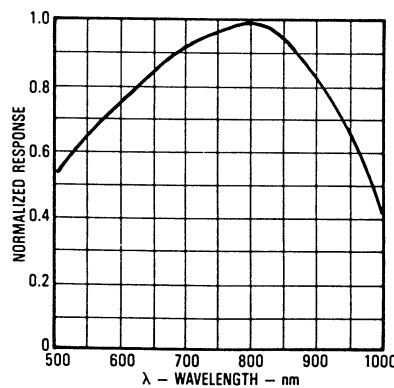

Angular Displacement from Package Mechanical Axis

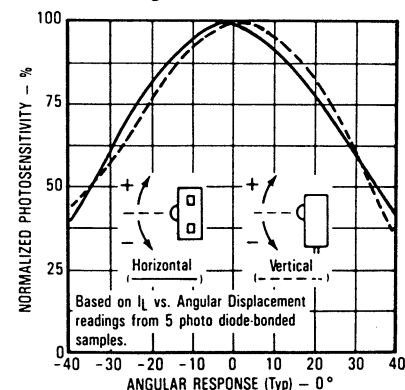

Types OPL562, OPL563 Series

Typical Performance Curves

Normalized Supply Current vs. Ambient Temperature

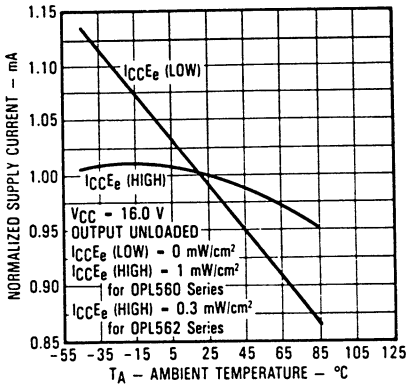

OPL560, OPL560-OC, OPL561, OPL561-OC Propagation Time vs. Amb. Temp.

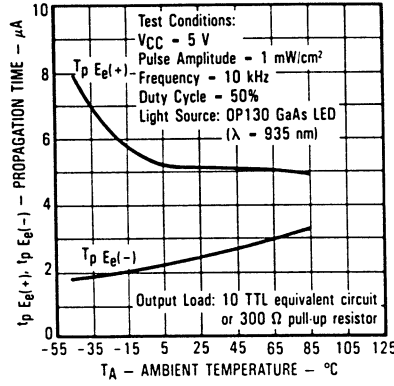

OPL562, OPL562-OC, OPL563, OPL563-OC Propagation Time vs. Amb. Temp.

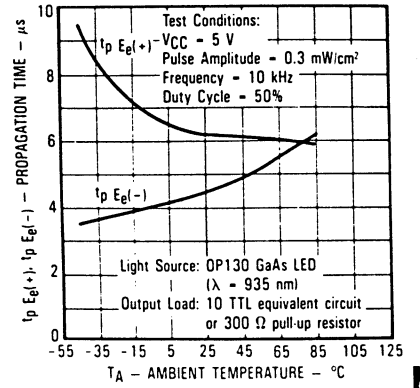

OPL560, OPL561, OPL562, OPL563 Rise Time & Fall Time vs. TA

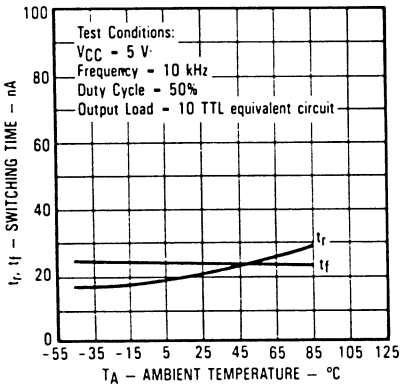

OPL560-OC, OPL561-OC, OPL562-OC, OPL563-OC Rise Time & Fall Time vs. TA vs. Output Load

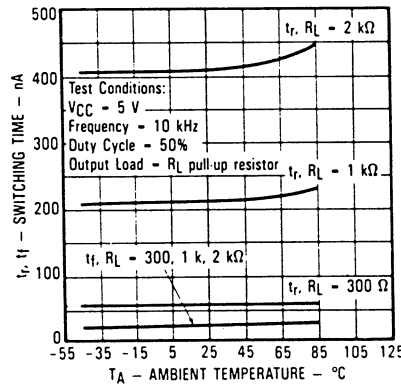

Switching Test Curves

Switching Test Curve for Inverters

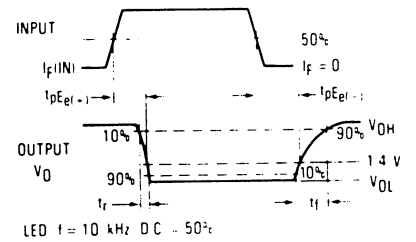

Switching Test Curve for Buffers

