

Round Through-Hole LED Lamp (3 mm)

OVLBx4C7 Series

- High brightness with well-defined spatial radiation patterns
- UV-resistant epoxy lens
- Lead-frame material is iron alloy with tin plated leads
- No stand-offs

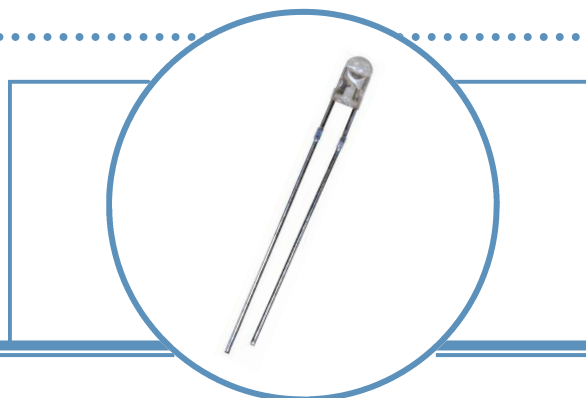

Each **OVLBx4C7** series device is a high-intensity LED mounted in a clear plastic T-1 package. The LED provides a well-defined and even emission pattern. Its UV-resistant epoxy lens makes this device an optimal solution for outdoor applications.

Applications

- Pedestrian signals
- Signage and architectural lighting
- Backlighting
- Automotive
- Outdoor/indoor displays

Part Number	Material	Emitted Color	Intensity Typ. mcd	Lens Color
OVLBB4C7	InGaN	Blue	1800	Clear
OVLBG4C7		Green	8400	Clear
OVLBR4C7	AlInGaP	Red	3700	Clear
OVLBY4C7		Yellow	3700	Clear

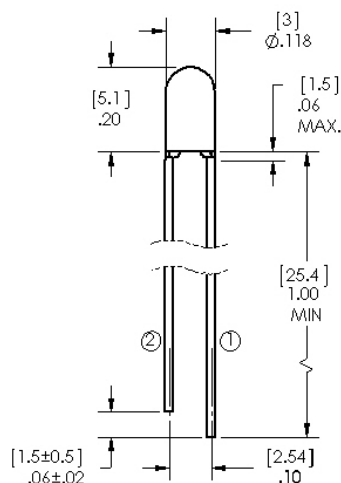

RoHS
ATTENTION
OBSERVE PRECAUTIONS
ELECTROSTATIC
SENSITIVE DEVICES

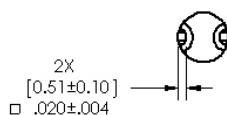

General tolerance +/- .25mm unless specified

- ① ANODE
- ② CATHODE

Dimensions are in Inches [MM]

**DO NOT LOOK DIRECTLY
AT LED WITH UNSHIELDED
EYES OR DAMAGE TO
RETINA MAY OCCUR.**

OPTEK reserves the right to make changes at any time in order to improve design and to supply the best product possible.

Round Through-Hole LED (3 mm)

OVLBx4C7 Series



Absolute Maximum Ratings (T_A = 25° C unless otherwise noted)

Storage Temperature Range		-40 ~ +100 °C
Operating Temperature Range		-40 ~ +100 °C
Reverse Voltage (Device not designed for reverse voltage applications)		5 V Max
Continuous Forward Current (Design of heat dissipation should be considered)	Blue, Green	25 mA
	Red, Yellow	50 mA
Peak Forward Current (10% Duty Cycle, 1 kHz)	Blue, Green	100 mA
	Red, Yellow	100 mA
Power Dissipation	Blue, Green	100 mW
	Red, Yellow	120 mW
Current Linearity vs Ambient Temperature	Blue, Green	-0.29 mA/°C
	Red, Yellow	-0.72 mA/°C
LED Junction Temperature		125° C
Electrostatic Discharge Classification (JEDEC-JESD22-A114F)		Class 1C
Lead Soldering Temperature (4 mm away from the base of the epoxy bulb)		260° C / 3 seconds

Electrical Characteristics (T_A = 25° C unless otherwise noted)

SYMBOL	PARAMETER	COLOR	MIN	TYP	MAX	UNITS	CONDITIONS
I _V	Luminous Intensity	Blue	1135	1800	----	mcd	I _F = 20 mA
		Green	4360	8400	----		
		Red	2225	3700	----		
		Yellow	2225	3700	----		
V _F	Forward Voltage	Blue	2.6	3.2	4.0	V	I _F = 20 mA
		Green					
		Red	1.8	2.0	2.4		
		Yellow					
I _R	Reverse Current	Blue	----	----	10	μA	V _R = 5 V
		Green	----	----			
		Red	----	----			
		Yellow	----	----			
λ _D	Dominant Wavelength	Blue	460	470	475	nm	I _F = 20 mA
		Green	519	525	531		
		Red	620	623	630		
		Yellow	585	589	595		
2Θ _½ H-H	50% Power Angle		----	45	----	deg	I _F = 20 mA

OPTEK reserves the right to make changes at any time in order to improve design and to supply the best product possible.

Round Through-Hole LED (3 mm)

OVLBx4C7 Series



Standard Bins

LEDs are sorted to luminous intensity (I_V), forward voltage (V_F) and dominant wavelength (nm) bins listed below. Each bag consists of a single intensity bin, single voltage bin and a single color bin. Orders are filled using all intensity and color bins listed in the following tables. Optek will not accept orders for single intensity bins, single voltage bins or single color bins.

Luminous Intensity (I_V) @ 20mA

Blue: OVLBB4C7		
IV Code	Min (mcd)	Max (mcd)
0S	1,135	1,590
0T	1,590	2,225
0U	2,225	3,115
0V	3,115	4,360
Green: OVLBG4C7		
IV Code	Min (mcd)	Max (mcd)
0W	4,360	6,105
0X	6,105	8,550
0Y	8,550	11,970
0Z	11,970	16,758

Forward Voltage (V_F)

Blue: OVLBB4C7 & Green: OVLBG4C7		
VF Code	Min	Max
A	2.6	2.8
B	2.8	3.0
C	3.0	3.2
D	3.2	3.4
E	3.4	3.6
F	3.6	3.8
G	3.8	4.0

Dominant Wavelength (nm)

Blue: OVLBB4C7		
nm Code	Min	Max
BC	460	465
BD	465	470
BE	470	475
Green: OVLBG4C7		
nm Code	Min	Max
FB	519	523
FC	523	527
FD	527	531

Luminous Intensity (I_V) @ 20mA

Red: OVLBR4C7		
IV Code	Min (mcd)	Max (mcd)
0U	2,225	3,115
0V	3,115	4,360
0W	4,360	6,105
Yellow: OVLBY4C7		
IV Code	Min (mcd)	Max (mcd)
0U	2,225	3,115
0V	3,115	4,360
0W	4,360	6,105

Forward Voltage (V_F)

Red: OVLBR4C7 & Yellow: OVLBY4C7		
VF Code	Min	Max
A	1.8	2.0
B	2.0	2.2
C	2.2	2.4

Dominant Wavelength (nm)

Red: OVLBR4C7		
nm Code	Min	Max
RA	620	625
RB	625	630
Yellow: OVLBY4C7		
nm Code	Min	Max
YC	585	587
YD	587	589
YE	589	591
YF	591	593
YG	593	595

OPTEK reserves the right to make changes at any time in order to improve design and to supply the best product possible.

Typical Electro-Optical Characteristics Curves (BLUE)

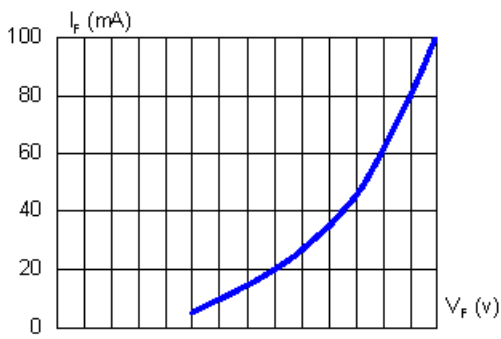

Fig.1 Forward Current vs. Forward Voltage

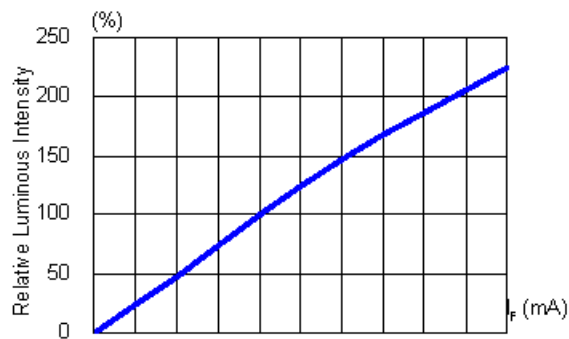

Fig.2 Luminous Intensity vs. Forward Current

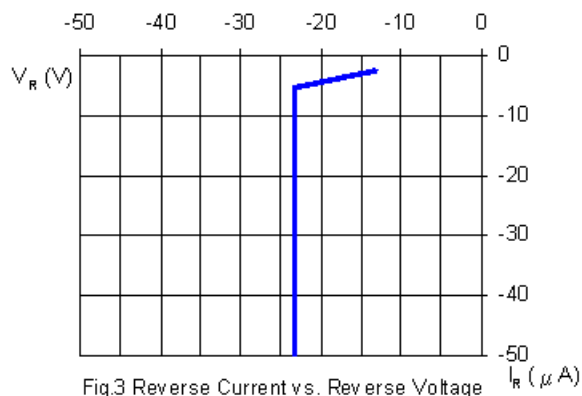

Fig.3 Reverse Current vs. Reverse Voltage

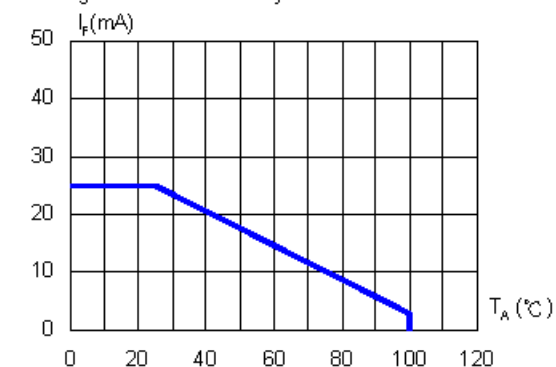

Fig.4 Allowable Forward Current vs. Ambient Temperature

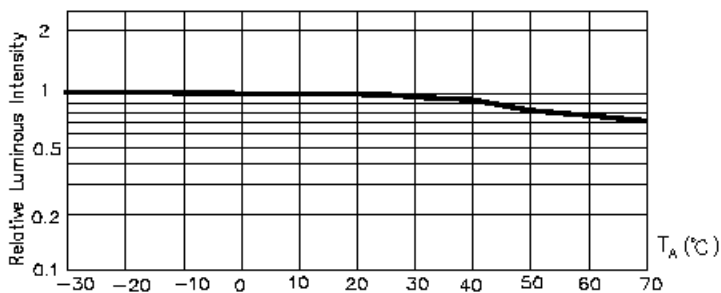

Fig.5 Luminous Intensity at $I_F=20mA$ vs. Ambient Temperature

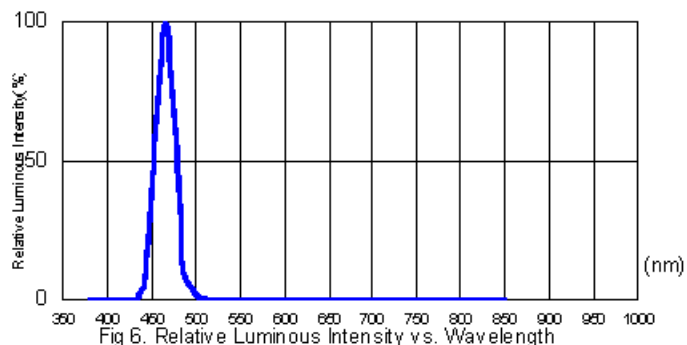

Fig.6. Relative Luminous Intensity vs. Wavelength

OPTEK reserves the right to make changes at any time in order to improve design and to supply the best product possible.

Typical Electro-Optical Characteristics Curves (GREEN)

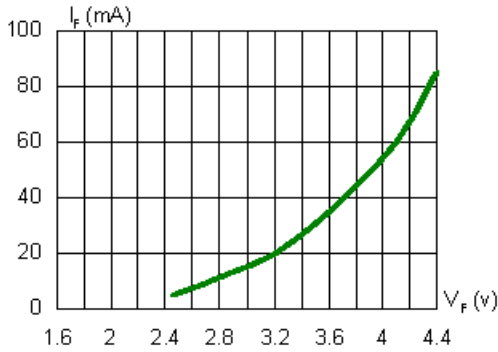

Fig.1 Forward Current vs. Forward Voltage

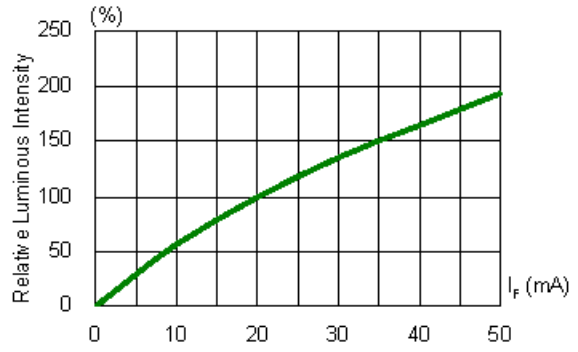

Fig.2 Luminous Intensity vs. Forward Current

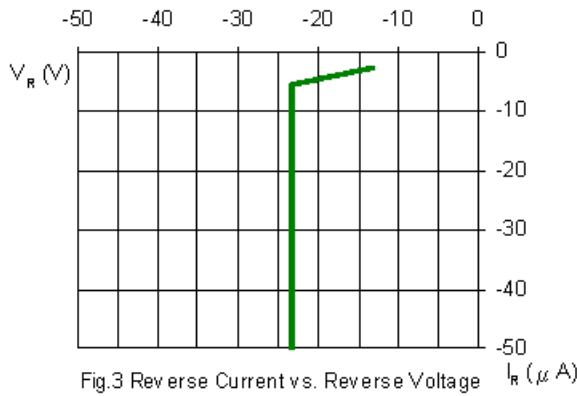

Fig.3 Reverse Current vs. Reverse Voltage

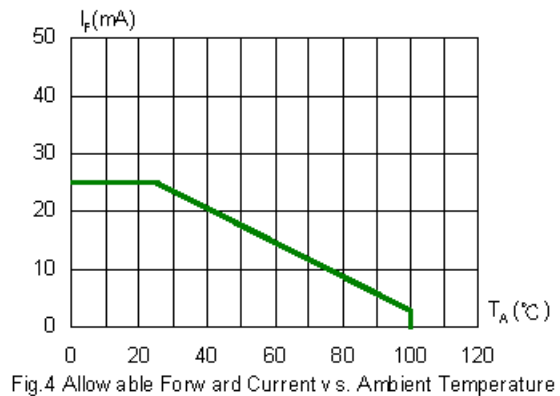

Fig.4 Allowable Forward Current vs. Ambient Temperature

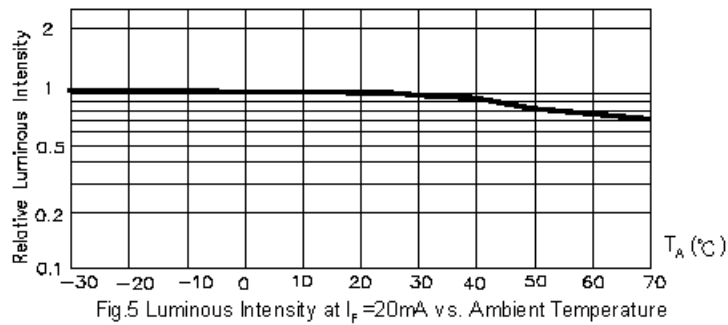

Fig.5 Luminous Intensity at $I_F = 20$ mA vs. Ambient Temperature

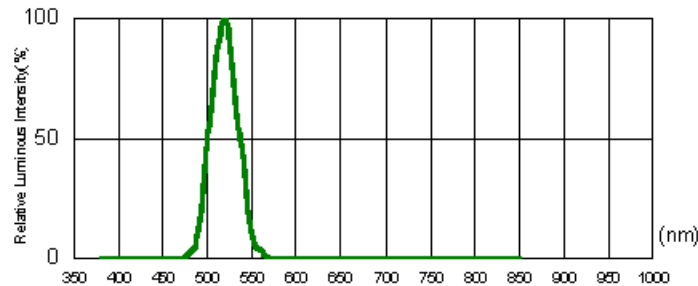

Fig.6. Relative Luminous Intensity vs. Wavelength

OPTEK reserves the right to make changes at any time in order to improve design and to supply the best product possible.

Typical Electro-Optical Characteristics Curves (RED)

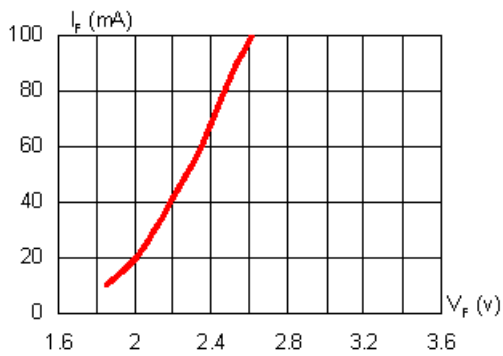

Fig.1 Forward Current vs. Forward Voltage

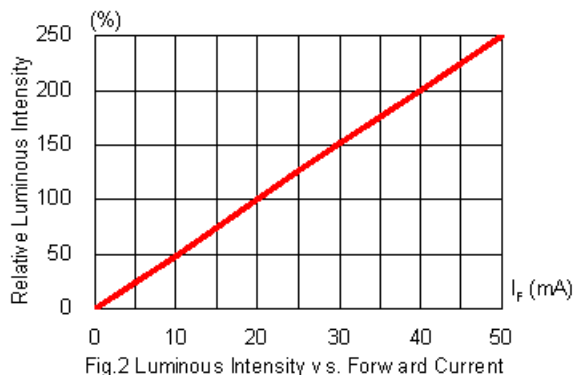

Fig.2 Luminous Intensity vs. Forward Current

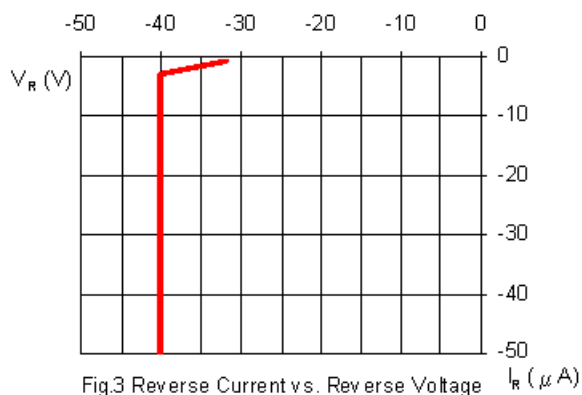

Fig.3 Reverse Current vs. Reverse Voltage

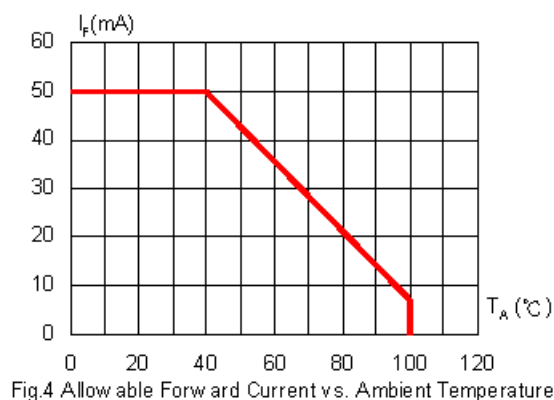

Fig.4 Allowable Forward Current vs. Ambient Temperature

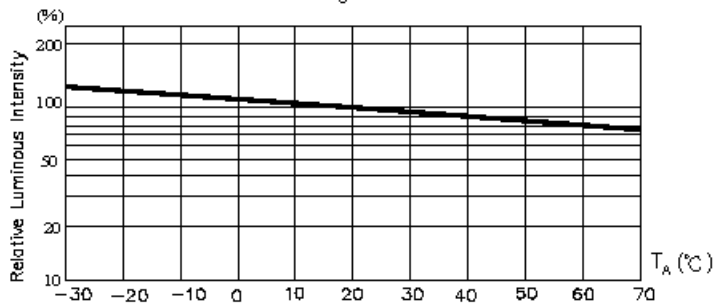

Fig.5 Luminous Intensity at $I_F = 20mA$ vs. Ambient Temperature

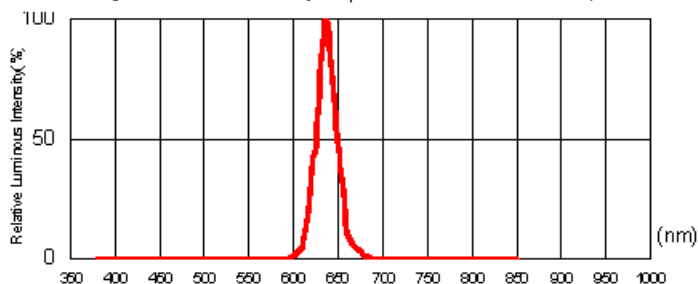

Fig.6. Relative Luminous Intensity vs. Wavelength

OPTEK reserves the right to make changes at any time in order to improve design and to supply the best product possible.

Typical Electro-Optical Characteristics Curves (YELLOW)

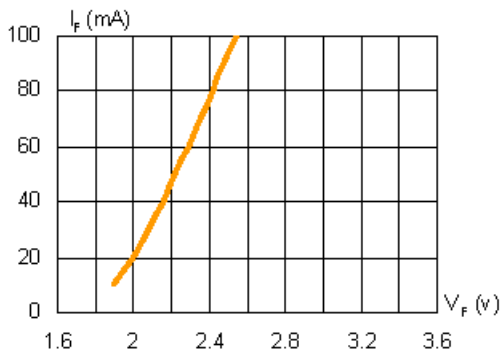

Fig.1 Forward Current vs. Forward Voltage

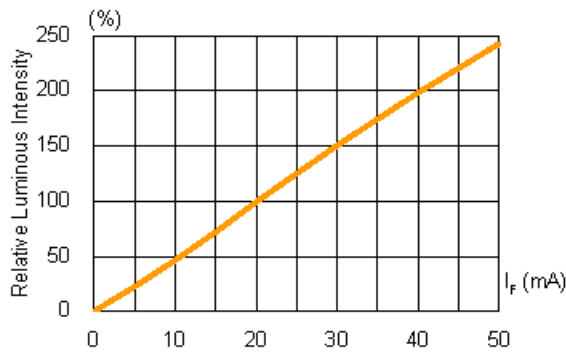

Fig.2 Luminous Intensity vs. Forward Current

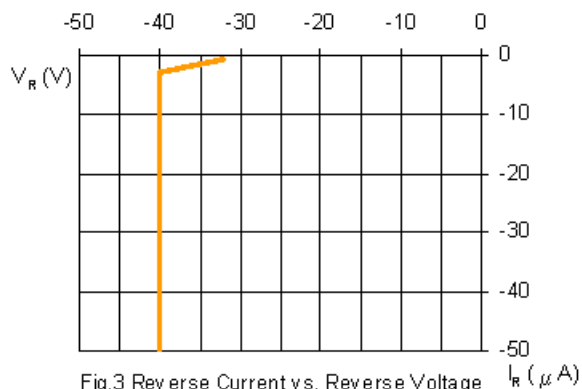

Fig.3 Reverse Current vs. Reverse Voltage

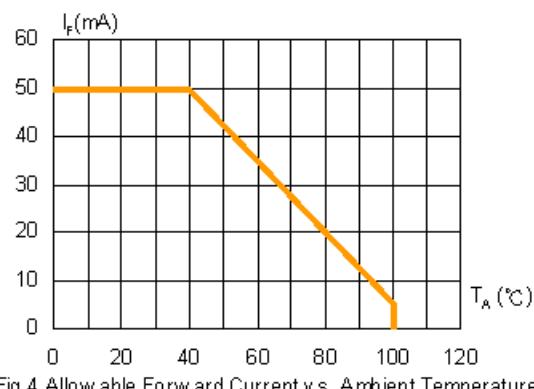

Fig.4 Allowable Forward Current vs. Ambient Temperature

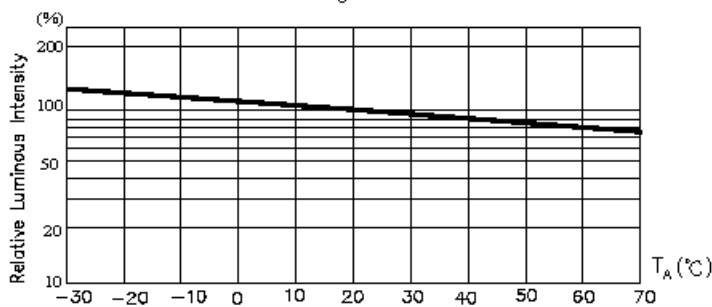

Fig.5 Luminous Intensity at $I_F=20mA$ vs. Ambient Temperature

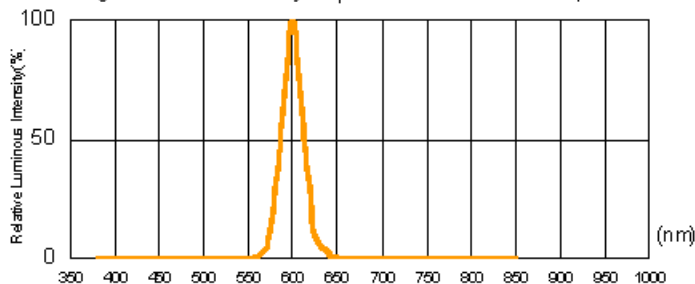

Fig.6. Relative Luminous Intensity vs. Wavelength

OPTEK reserves the right to make changes at any time in order to improve design and to supply the best product possible.

Round Through-Hole LED (3 mm) OVLBx4C7 Series

Beam Pattern:

(Blue) and (Green)

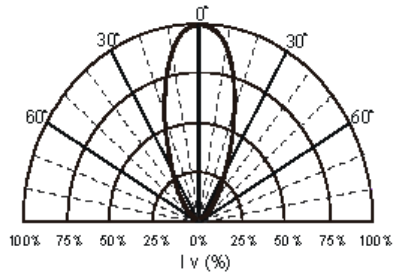

(Red) and (Yellow)

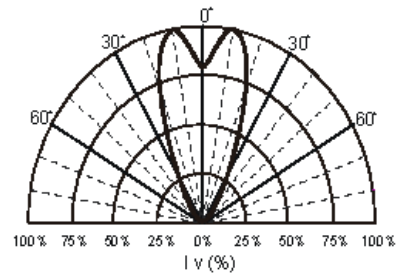

Packaging: 500 pcs per bulk bag with desiccant

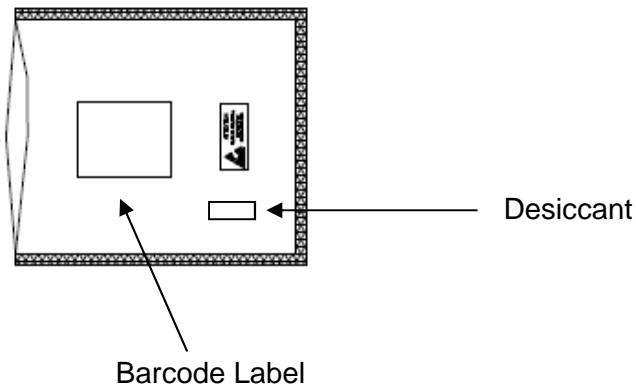

OPTEK reserves the right to make changes at any time in order to improve design and to supply the best product possible.

Reliability Test

LED lamps are checked by reliability tests based on MIL standards.

Classification	Test Item	Standard Test Method	Test Conditions	Duration	Unit	Acc / Rej Criteria	Result
Life Test	Operation Life Test (OLT)	MIL-STD-750D Method 1026.3	$T_A=25^{\circ}\text{C}$, $I_F=30\text{mA}$ *	1000 Hrs	100	0 / 1	Pass
Environment Test	High Temperature Storage (HTS)	MIL-STD-750D Method 1032.1	$T_A=100^{\circ}\text{C}$	1000 Hrs	100	0 / 1	Pass
	Low Temperature Storage (LTS)	MIL-STD-750D Method 1032.1	$T_A=-40^{\circ}\text{C}$	1000 Hrs	100	0 / 1	Pass
	Temp. & Humidity with Bias (THB)	MIL-STD-750D Method 103B	$T_A=85^{\circ}\text{C}$, $\text{Rh}=85\%$ $I_F=20\text{mA}$ **	500 Hrs	100	0 / 1	Pass
	Thermal Shock Test (TST)	MIL-STD-750D Method 1056.1	$0^{\circ}\text{C} \sim 100^{\circ}\text{C}$ 2min 2min	100 cycles	100	0 / 1	Pass
	Temperature Cycling Test (TCT)	MIL-STD-750D Method 1051.5	$-40^{\circ}\text{C} \sim 25^{\circ}\text{C} \sim 100^{\circ}\text{C} \sim 25^{\circ}\text{C}$ 30min 5min 30min 5min	100 cycles	100	0 / 1	Pass
Mechanical Test	Solderability	MIL-STD-750D Method 2026.4	$235\pm 5^{\circ}\text{C}$, 5 sec	1 time	20	0 / 1	Pass
	Resistance to Soldering Heat	MIL-STD-750D Method 2031.1	$260\pm 5^{\circ}\text{C}$, 10 sec	1 time	20	0 / 1	Pass
	Lead Integrity	MIL-STD-750D Method 2036.3	Load 2.5N (0.25kgf) $0^{\circ} \sim 90^{\circ} \sim 0^{\circ}$, bend	3 times	20	0 / 1	Pass

Remark : (*) $I_F=30\text{mA}$ for AlInGaP chip ; $I_F=20\text{mA}$ for InGaN chip

(**) $I_F=20\text{mA}$ for AlInGaP chip ; $I_F=10\text{mA}$ for InGaN chip

2. Failure Criteria ($T_A=25^{\circ}\text{C}$):

Test Item	Symbol	Test Conditions	Criteria for Judgment	
			Min.	Max.
Luminous Intensity	I_V	$I_F=20\text{mA}$	$\text{LSL}\times 0.7$ **	
Voltage (Forward)	V_F	$I_F=20\text{mA}$		$\text{USL}\times 1.1$ *

(*) USL : Upper Standard Level , (**) LSL : Lower Standard Level

OPTEK reserves the right to make changes at any time in order to improve design and to supply the best product possible.

Mouser Electronics

Authorized Distributor

Click to View Pricing, Inventory, Delivery & Lifecycle Information:

[TT Electronics:](#)

[OVLBB4C7](#) [OVLBY4C7](#)