

# HR423.22

423.22MHz One-Port SAW Resonator

---



Approved by:
Checked by:
Issued by:

## SPECIFICATION

PRODUCT: SAW RESONATOR

---

MODEL: HR423.22 F-11

---

**HOPE MICROELECTRONICS CO., LIMITED**

The HR423.22 is a true one-port, surface-acoustic-wave (SAW) resonator in a low-profile metal F-11 case. It provides reliable, fundamental-mode, quartz frequency stabilization i.e. in transmitters or local oscillators operating at 423.220 MHz.

1.Package Dimension (F-11)

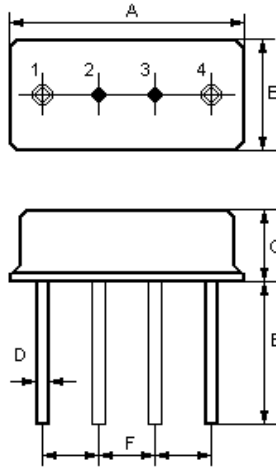

Pin	Configuration
1,4	Input / Output
2/3	Case Ground

Dimension	Data (unit: mm)
A	11.0±0.3
B	4.5±0.3
C	3.2±0.3
D	0.45±0.1
E	5.0±0.5
F	2.54±0.2

2.Marking

HR423.22

Color: Black or Blue

3.Equivalent LC Model and Test Circuit

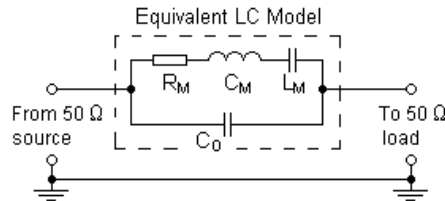

4.Typical Application Circuits

1) Low-Power Transmitter Application

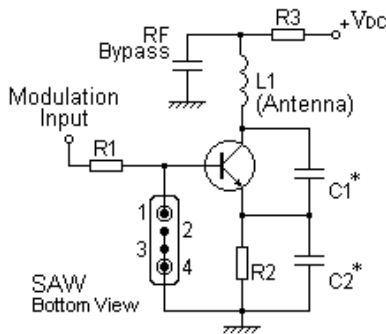

2) Local Oscillator Application

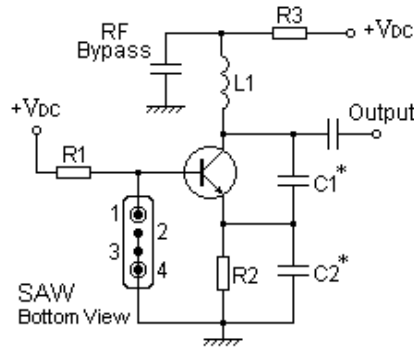

5.Typical Frequency Response

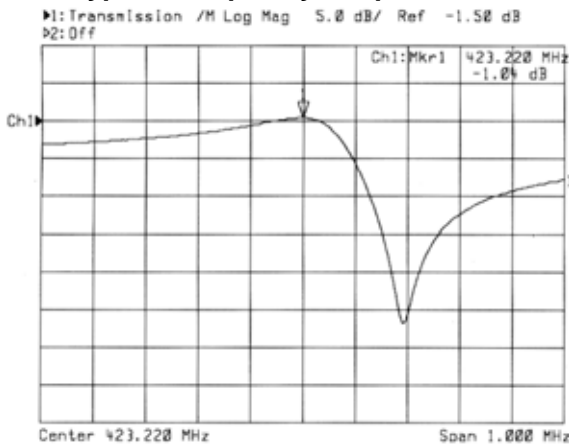

6.Temperature Characteristics

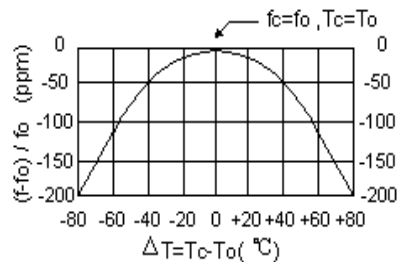

The curve shown above accounts for resonator contribution only and does not include oscillator temperature characteristics.

## 7.Performance

### 7-1.Maximum Ratings

Rating		Value	Unit
CW RF Power Dissipation	$P$	0	dBm
DC Voltage Between Any two Pins	$V_{DC}$	$\pm 30$	V
Storage Temperature Range	$T_{stg}$	-40 to +85	
Operating Temperature Range	$T_A$	-10 to +60	

### 7-2.Electronic Characteristics

Characteristic		Sym	Minimum	Typical	Maximum	Unit
Center Frequency (+25 °C)	Absolute Frequency	$f_C$	423.145		423.295	MHz
	Tolerance from 423.220MHz	$\Delta f_C$		$\pm 75$		kHz
Insertion Loss		IL		1.5	2.0	dB
Quality Factor	Unloaded Q	$Q_U$		11,600		
	50 $\Omega$ Loaded Q	$Q_L$		1,850		
Temperature Stability	Turnover Temperature	$T_0$	25		55	
	Turnover Frequency	$f_0$		$f_C$		kHz
	Frequency Temperature Coefficient	FTC		0.032		ppm/ °C
Frequency Aging	Absolute Value during the First Year	$ f_A $		10		ppm/yr
DC Insulation Resistance Between Any Two Pins			1.0			M $\Omega$
RF Equivalent RLC Model	Motional Resistance	$R_M$		19	26	$\Omega$
	Motional Inductance	$L_M$		82.8310		$\mu$ H
	Motional Capacitance	$C_M$		1.7091		fF
	Pin 1 to Pin 4 Static Capacitance	$C_0$	1.65	1.95	2.25	pF

**ⓘ CAUTION: Electrostatic Sensitive Device. Observe precautions for handling!**

### C 2003. All Rights Reserved.

- The center frequency,  $f_C$ , is measured at the minimum IL point with the resonator in the 50  $\Omega$  test system.
- Unless noted otherwise, case temperature  $T_C = +25^\circ\text{C} \pm 2^\circ\text{C}$ .
- Frequency aging is the change in  $f_C$  with time and is specified at +65°C or less. Aging may exceed the specification for prolonged temperatures above +65°C. Typically, aging is greatest the first year after manufacture, decreasing in subsequent years.
- Turnover temperature,  $T_0$ , is the temperature of maximum (or turnover) frequency,  $f_0$ . The nominal frequency at any case temperature,  $T_C$ , may be calculated from:  $f = f_0 [1 - \text{FTC} (T_0 - T_C)^2]$ .
- This equivalent RLC model approximates resonator performance near the resonant frequency and is provided for reference only. The capacitance  $C_0$  is the measured static (nonmotional) capacitance between Pin1 and Pin4. The measurement includes case parasitic capacitance.
- Derived mathematically from one or more of the following directly measured parameters:  $f_C$ , IL, 3 dB bandwidth,  $f_C$  versus  $T_C$ , and  $C_0$ .
- The specifications of this device are based on the test circuit shown above and subject to change or obsolescence without notice.
- Typically, equipment utilizing this device requires emissions testing and government approval, which is the responsibility of the equipment manufacturer.
- Our liability is only assumed for the Surface Acoustic Wave (SAW) component(s) per se, not for applications, processes and circuits implemented within components or assemblies.
- For questions on technology, prices and delivery, please contact our sales offices or e-mail [sales@hoperf.com](mailto:sales@hoperf.com).