

Cree® 5mm Round LED C535A-WJN



PRODUCT DESCRIPTION

Round LEDs offer superior light output for excellent readability in sunlight and dependable performance. They provide extremely stable light output over long periods of time.

These lamps are made with an advanced optical grade epoxy offering superior high temperature and high moisture resistance performance in lighting and illumination applications.

FEATURES

- Size (mm): 5
- Color Temperatures(K):
Cool White :
Min . (4600) / Typical (9000)
- Luminous Intensity (mcd)
C535A-WJN (770-4180)
- Viewing angle: 110 degree
- Lead-Free
- RoHS Compliant

APPLICATIONS

- Garden Light
- Light Strip
- Channel Letter
- Retail Display Lighting

ABSOLUTE MAXIMUM RATINGS ($T_A = 25^\circ\text{C}$)

Items	Symbol	Absolute Maximum Rating	Unit
Forward Current	I_F	25	mA
Peak Forward Current ^{Note}	I_{FP}	100	mA
Reverse Voltage	V_R	5	V
Power Dissipation	P_D	100	mW
Operation Temperature	T_{opr}	-40 ~ +95	$^\circ\text{C}$
Storage Temperature	T_{stg}	-40 ~ +100	$^\circ\text{C}$
Lead Soldering Temperature	T_{sol}	Max. 260 $^\circ\text{C}$ for 3 sec. max. (3 mm from the base of the epoxy bulb)	

Note: Pulse width ≤ 0.1 msec, duty $\leq 1/10$.

TYPICAL ELECTRICAL & OPTICAL CHARACTERISTICS ($T_A = 25^\circ\text{C}$)

Characteristics	Symbol	Condition	Unit	Minimum	Typical	Maximum
Forward Voltage	V_F	$I_F = 20$ mA	V		3.2	4.0
Reverse Current	I_R	$V_R = 5$ V	μA			100
Luminous Intensity	I_v	$I_F = 20$ mA	mcd	770	2750	
Chromaticity Coordinates	x	$I_F = 20$ mA			0.2895	
	y	$I_F = 20$ mA			0.2905	
50% Power Angle	$2\theta_{1/2}$	$I_F = 20$ mA	deg		110	

INTENSITY BIN LIMIT ($I_f = 20 \text{ mA}$)

Cool White

Bin Code	Min. (mcd)	Max. (mcd)
S0	770	1100
T0	1100	1520
U0	1520	2130
V0	2130	3000
W0	3000	4180

- Tolerance of measurement of luminous intensity is $\pm 15\%$

VF BIN LIMIT ($I_f = 20 \text{ mA}$)

Cool White

Bin Code	Min. (V)	Max. (V)
27	2.8	3.0
28	3.0	3.2
29	3.2	3.4
2a	3.4	3.6
2b	3.6	3.8
2c	3.8	4.0

- Tolerance of measurement of VF is $\pm 0.05\text{V}$.

COLOR BIN LIMIT ($I_f = 20 \text{ mA}$)

Bin Code	Sub-bin	x	y
W1	Wa1	0.2449	0.2288
		0.2497	0.2384
		0.2543	0.2356
		0.2497	0.2267
	Wa2	0.2497	0.2267
		0.2543	0.2356
		0.2589	0.2328
		0.2545	0.2245
	Wa3	0.2497	0.2384
		0.2545	0.2480
		0.2589	0.2445
		0.2543	0.2356
	Wa4	0.2543	0.2356
		0.2589	0.2445
		0.2633	0.2410
		0.2589	0.2328
	Wb1	0.2545	0.2245
		0.2589	0.2328
		0.2635	0.2299
		0.2593	0.2223
	Wb2	0.2593	0.2223
		0.2635	0.2299
		0.2680	0.2270
		0.2640	0.2200
	Wb3	0.2589	0.2328
		0.2633	0.2410
		0.2677	0.2375
		0.2635	0.2299
Wb4	0.2635	0.2299	
	0.2677	0.2375	
	0.2720	0.2340	
	0.2680	0.2270	

Bin Code	Sub-bin	x	y
W1	Wc1	0.2545	0.2480
		0.2593	0.2575
		0.2635	0.2534
		0.2589	0.2445
	Wc2	0.2589	0.2445
		0.2635	0.2534
		0.2677	0.2493
		0.2633	0.2410
	Wc3	0.2593	0.2575
		0.2640	0.2670
		0.2680	0.2623
		0.2635	0.2534
	Wc4	0.2635	0.2534
		0.2680	0.2623
		0.2720	0.2575
		0.2677	0.2493
	Wd1	0.2633	0.2410
		0.2677	0.2493
		0.2718	0.2451
		0.2677	0.2375
	Wd2	0.2677	0.2375
		0.2718	0.2451
		0.2760	0.2410
		0.2720	0.2340
	Wd3	0.2677	0.2493
		0.2720	0.2575
		0.2760	0.2528
		0.2718	0.2451
Wd4	0.2718	0.2451	
	0.2760	0.2528	
	0.2800	0.2480	
	0.2760	0.2410	

Bin Code	Sub-bin	x	y
W2	We1	0.2640	0.2670
		0.2688	0.2765
		0.2726	0.2711
		0.2680	0.2623
	We2	0.2680	0.2623
		0.2726	0.2711
		0.2764	0.2658
		0.2720	0.2575
	We3	0.2688	0.2765
		0.2735	0.2860
		0.2772	0.2800
		0.2726	0.2711
	We4	0.2726	0.2711
		0.2772	0.2800
		0.2808	0.2740
		0.2764	0.2658
	Wf1	0.2720	0.2575
		0.2764	0.2658
		0.2802	0.2604
		0.2760	0.2528
	Wf2	0.2760	0.2528
		0.2802	0.2604
		0.2840	0.2550
		0.2800	0.2480
	Wf3	0.2764	0.2658
		0.2808	0.2740
		0.2844	0.2680
		0.2802	0.2604
Wf4	0.2802	0.2604	
	0.2844	0.2680	
	0.2880	0.2620	
	0.2840	0.2550	

- Tolerance of measurement of the color coordinates is ± 0.01 .

COLOR BIN LIMIT ($I_f = 20 \text{ mA}$)

Bin Code	Sub-bin	x	y
W2	Wg1	0.2735	0.2860
		0.2783	0.2955
		0.2817	0.2889
		0.2772	0.2800
	Wg2	0.2772	0.2800
		0.2817	0.2889
		0.2852	0.2823
		0.2808	0.2740
	Wg3	0.2783	0.2955
		0.2830	0.3050
		0.2863	0.2978
		0.2817	0.2889
	Wg4	0.2817	0.2889
		0.2863	0.2978
		0.2895	0.2905
		0.2852	0.2823
	Wh1	0.2808	0.2740
		0.2852	0.2823
		0.2886	0.2756
		0.2844	0.2680
	Wh2	0.2844	0.2680
		0.2886	0.2756
		0.2920	0.2690
		0.2880	0.2620
	Wh3	0.2852	0.2823
		0.2895	0.2905
		0.2928	0.2833
		0.2886	0.2756
Wh4	0.2886	0.2756	
	0.2928	0.2833	
	0.2960	0.2760	
	0.2920	0.2690	

Bin Code	Sub-bin	x	y
W3	Wj1	0.2830	0.3050
		0.2890	0.3130
		0.2918	0.3048
		0.2863	0.2978
	Wj2	0.2863	0.2978
		0.2918	0.3048
		0.2947	0.2967
		0.2895	0.2905
	Wj3	0.2890	0.3130
		0.2950	0.3210
		0.2974	0.3119
		0.2918	0.3048
	Wj4	0.2918	0.3048
		0.2974	0.3119
		0.2998	0.3028
		0.2947	0.2967
	Wk1	0.2895	0.2905
		0.2947	0.2967
		0.2975	0.2890
		0.2928	0.2833
	Wk2	0.2928	0.2833
		0.2975	0.2890
		0.3003	0.2813
		0.2960	0.2760
	Wk3	0.2947	0.2967
		0.2998	0.3028
		0.3022	0.2946
		0.2975	0.2890
Wk4	0.2975	0.2890	
	0.3022	0.2946	
	0.3045	0.2865	
	0.3003	0.2813	

Bin Code	Sub-bin	x	y
W3	Wm1	0.2950	0.3210
		0.3010	0.3290
		0.3030	0.3190
		0.2974	0.3119
	Wm2	0.2974	0.3119
		0.3030	0.3190
		0.3050	0.3090
		0.2998	0.3028
	Wm3	0.3010	0.3290
		0.3070	0.3370
		0.3085	0.3260
		0.3030	0.3190
	Wm4	0.3030	0.3190
		0.3085	0.3260
		0.3100	0.3150
		0.3050	0.3090
	Wn1	0.2998	0.3028
		0.3050	0.3090
		0.3070	0.3005
		0.3022	0.2946
	Wn2	0.3022	0.2946
		0.3070	0.3005
		0.3090	0.2920
		0.3045	0.2865
	Wn3	0.3050	0.3090
		0.3100	0.3150
		0.3115	0.3060
		0.3070	0.3005
Wn4	0.3070	0.3005	
	0.3115	0.3060	
	0.3130	0.2970	
	0.3090	0.2920	

- Tolerance of measurement of the color coordinates is ± 0.01 .

COLOR BIN LIMIT ($I_f = 20 \text{ mA}$)

Bin Code	Sub-bin	x	y
W4	Wp1	0.3070	0.3370
		0.3130	0.3430
		0.3140	0.3320
		0.3085	0.3260
	Wp2	0.3085	0.3260
		0.3140	0.3320
		0.3150	0.3210
		0.3100	0.3150
	Wp3	0.3130	0.3430
		0.3190	0.3490
		0.3195	0.3380
		0.3140	0.3320
	Wp4	0.3140	0.3320
		0.3195	0.3380
		0.3200	0.3270
		0.3150	0.3210
	Wq1	0.3100	0.3150
		0.3150	0.3210
		0.3163	0.3118
		0.3115	0.3060
	Wq2	0.3115	0.3060
		0.3163	0.3118
		0.3175	0.3025
		0.3130	0.2970
	Wq3	0.3150	0.3210
		0.3200	0.3270
		0.3208	0.3173
		0.3163	0.3118
	Wq4	0.3163	0.3118
		0.3208	0.3173
		0.3215	0.3075
		0.3175	0.3025

Bin Code	Sub-bin	x	y
W4	Wr1	0.3190	0.3490
		0.3245	0.3545
		0.3248	0.3438
		0.3195	0.3380
	Wr2	0.3195	0.3380
		0.3248	0.3438
		0.3250	0.3330
		0.3200	0.3270
	Wr3	0.3245	0.3545
		0.3300	0.3600
		0.3300	0.3495
		0.3248	0.3438
	Wr4	0.3248	0.3438
		0.3300	0.3495
		0.3300	0.3390
		0.3250	0.3330
	Ws1	0.3200	0.3270
		0.3250	0.3330
		0.3255	0.3230
		0.3208	0.3173
	Ws2	0.3208	0.3173
		0.3255	0.3230
		0.3260	0.3130
		0.3215	0.3075
	Ws3	0.3250	0.3330
		0.3300	0.3390
		0.3300	0.3285
		0.3255	0.3230
Ws4	0.3255	0.3230	
	0.3300	0.3285	
	0.3300	0.3180	
	0.3260	0.3130	

Bin Code	Sub-bin	x	y
W5	Wt1	0.3300	0.3600
		0.3378	0.3663
		0.3375	0.3563
		0.3300	0.3495
	Wt2	0.3300	0.3495
		0.3375	0.3563
		0.3372	0.3463
		0.3300	0.3390
	Wt3	0.3378	0.3663
		0.3455	0.3725
		0.3449	0.3630
		0.3375	0.3563
	Wt4	0.3375	0.3563
		0.3449	0.3630
		0.3443	0.3535
		0.3372	0.3463
	Wu1	0.3300	0.3390
		0.3372	0.3463
		0.3368	0.3363
		0.3300	0.3285
	Wu2	0.3300	0.3285
		0.3368	0.3363
		0.3365	0.3263
		0.3300	0.3180
	Wu3	0.3372	0.3463
		0.3443	0.3535
		0.3437	0.3440
		0.3368	0.3363
	Wu4	0.3368	0.3363
		0.3437	0.3440
		0.3430	0.3345
		0.3365	0.3263

- Tolerance of measurement of the color coordinates is ± 0.01 .

COLOR BIN LIMIT ($I_f = 20 \text{ mA}$)

Bin Code	Sub-bin	x	y
W5	Wv1	0.3455	0.3725
		0.3533	0.3788
		0.3523	0.3698
		0.3449	0.3630
	Wv2	0.3449	0.3630
		0.3523	0.3698
		0.3514	0.3608
		0.3443	0.3535
	Wv3	0.3533	0.3788
		0.3610	0.3850
		0.3598	0.3765
		0.3523	0.3698
	Wv4	0.3523	0.3698
		0.3598	0.3765
		0.3585	0.3680
		0.3514	0.3608
	Ww1	0.3443	0.3535
		0.3514	0.3608
		0.3505	0.3518
		0.3437	0.3440
	Ww2	0.3437	0.3440
		0.3505	0.3518
		0.3495	0.3428
		0.3430	0.3345
	Ww3	0.3514	0.3608
		0.3585	0.3680
		0.3573	0.3595
		0.3505	0.3518
Ww4	0.3505	0.3518	
	0.3573	0.3595	
	0.3560	0.3510	
	0.3495	0.3428	

- Tolerance of measurement of the color coordinates is ± 0.01 .

CIE CHROMATICITY DIAGRAM

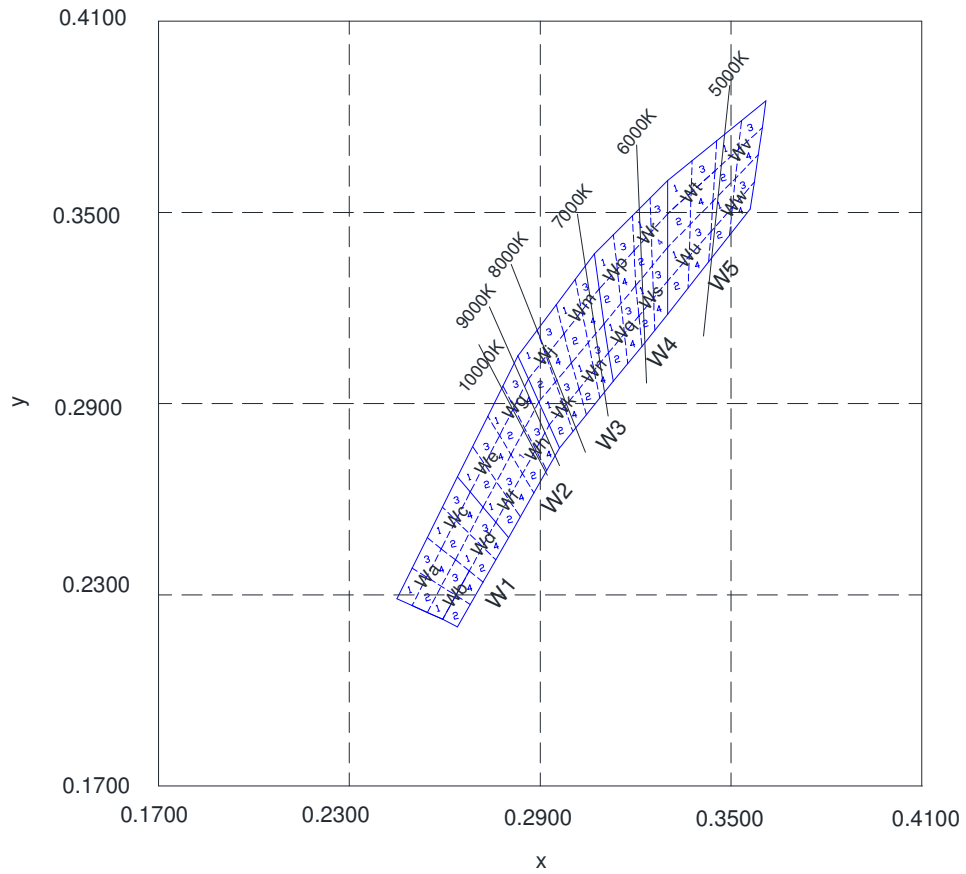

ORDER CODE TABLE*

Color	Kit Number	Viewing Angle	Luminous Intensity (mcd)		Color Bin Code
			Min.	Max.	
Cool White	C535A-WJN-CS0V0151	110	770	3000	W1,W2,W3,W4,W5
Cool White	C535A-WJN-CS0V0231	110	770	3000	W2,W3
Cool White	C535A-WJN-CT0V0231	110	1100	3000	W2,W3
Cool White	C535A-WJN-CU0V0231	110	1520	3000	W2,W3
Cool White	C535A-WJN-CT0W0151	110	1100	4180	W1,W2,W3,W4,W5
Cool White	C535A-WJN-CV0W0231	110	2130	4180	W2,W3

Notes:

1. The above kit numbers represent order codes that include multiple intensity-bin and color-bin codes. Only one intensity-bin code and one color-bin code will be shipped on each bulk. Single intensity-bin code and single color-bin codes will not be orderable.
2. Please refer to the "Cree LED Lamp Reliability Test Standards" document for reliability test conditions.
3. Please refer to the "Cree LED Lamp Soldering & Handling" document for information about how to use this LED product safely.

GRAPHS

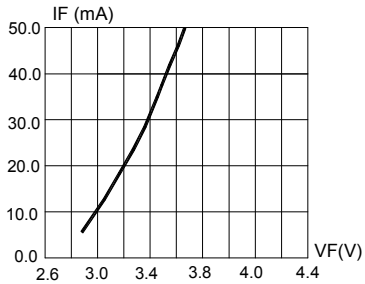

FIG.1 FORWARD CURRENT VS. FORWARD VOLTAGE.

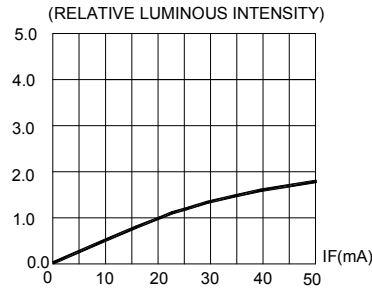

FIG.2 RELATIVE LUMINOUS INTENSITY VS. FORWARD CURRENT

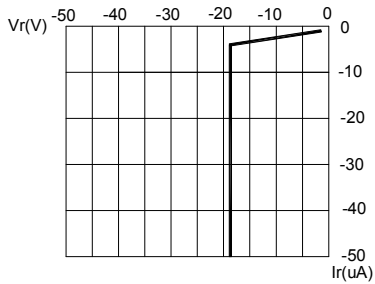

FIG.3 REVERSE CURRENT VS. REVERSE VOLTAGE.

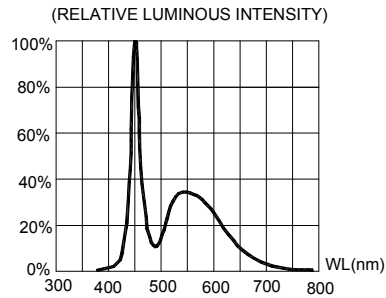

FIG.4 RELATIVE LUMINOUS INTENSITY VS. WAVELENGTH.

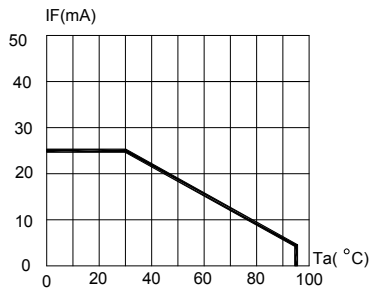

FIG.5 MAXIMUM FORWARD DC CURRENT VS AMBIENT TEMPERATURE (Tjmax=105°C)

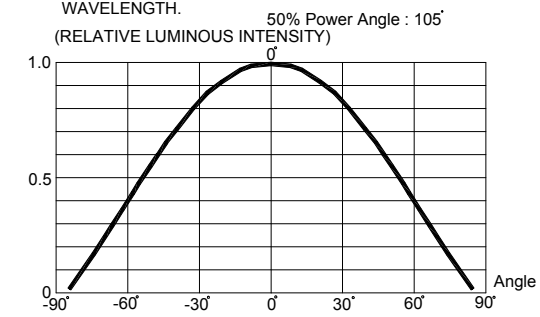

FIG.6 FAR FIELD PATTERN

The above data are collected from statistical figures that do not necessarily correspond to the actual parameters of each single LED. Hence, these data will be changed without further notice.

MECHANICAL DIMENSIONS

All dimensions are in mm. Tolerance is ± 0.25 mm unless otherwise noted.

An epoxy meniscus may extend about 1.5 mm down the leads.

Burr around bottom of epoxy may be 0.5 mm max.

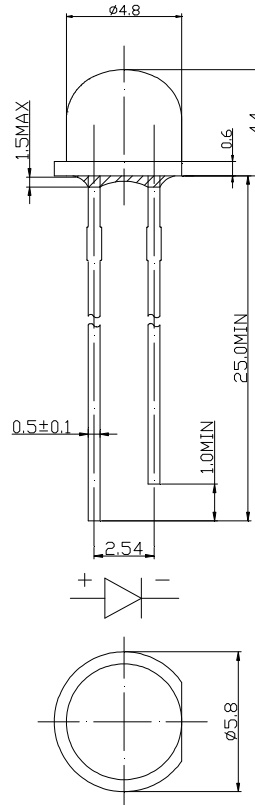

NOTES

RoHS Compliance

The levels of environmentally sensitive, persistent biologically toxic (PBT), persistent organic pollutants (POP), or otherwise restricted materials in this product are below the maximum concentration values (also referred to as the threshold limits) permitted for such substances, or are used in an exempted application, in accordance with EU Directive 2002/95/EC on the restriction of the use of certain hazardous substances in electrical and electronic equipment (RoHS), as amended through April 21, 2006.

Vision Advisory Claim

Users should be cautioned not to stare at the light of this LED product. The bright light can damage the eye.

KIT NUMBER SYSTEM

All dimensions in mm. Cree LED lamps are tested and sorted into performance bins. A bin is specified by ranges of color, forward voltage, and brightness. Sorted LEDs are packaged for shipping in various convenient options. Please refer to the "Cree LED Lamp Packaging Standard" document for more information about shipping and packaging options.

Cree LEDs are sold by order codes in combinations of bins called kits. Order codes are configured in the following manner:

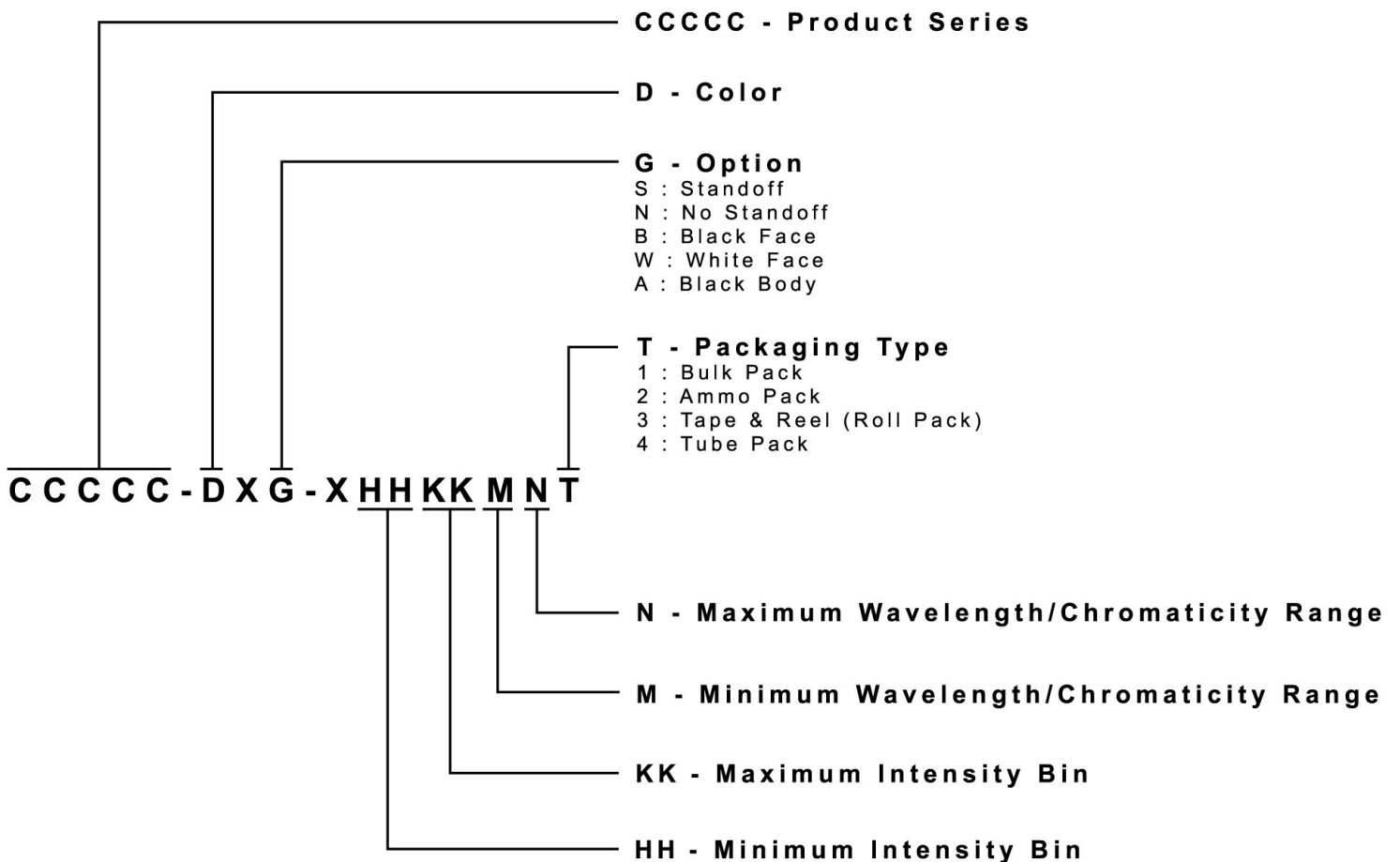

PACKAGING

Features:

- The LEDs are packed in cardboard boxes after packaging in normal or anti-electrostatic bags.
- Cardboard boxes will be used to protect the LEDs from mechanical shock during transportation.
- The boxes are not water resistant, and they must be kept away from water and moisture.
- The Bulk Pack types of packaging.
- Max 500 pcs per bag.

