

NARROW-PITCH CONNECTORS FOR BOARD-TO-FPC CONNECTION

NARROW PITCH (0.4mm) CONNECTORS F4

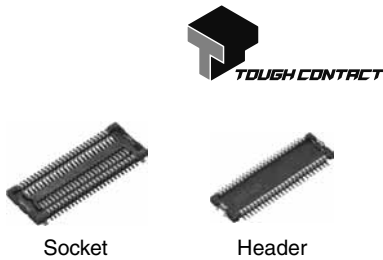

Compliance with RoHS Directive

3. Improved mating strength between the socket and header

The simple locking structures provided for the soldering terminals and the contact points improve the mating strength and provide tactile feedback when locked.

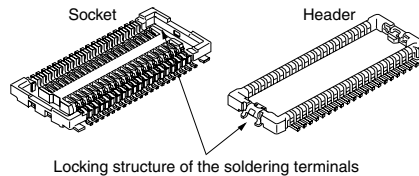

4. Easy to design product circuits

1) An insulating wall provided for the bottom surface of the connector prevents contact between the pattern on the PC board and the metal pins, enabling pattern wiring under the connector, and thus contributing to the reduction in size of PC boards.

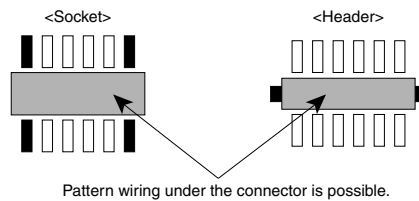

2) The usage shown below further enhances the flexibility of connector positioning.

[Example of application of connection between a board and an FPC]

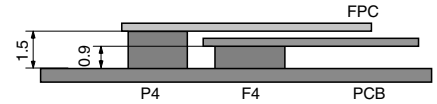

5. Connectors for inspection available

Connectors for inspection are available that are ideal for modular unit inspection and inspection in device assembly processes.

FEATURES

1. The lowest profile class among two-piece connectors in the world (Mated height: 0.9mm)

Achieved both a 0.4 mm pitch and an ultra low profile of 0.9 mm high when mated, contributing to further thickness reduction of products.

2. Strong resistance to adverse environments! Utilizes TOUGH CONTACT construction for high contact reliability.

(See Page 6 for details of the structure)

APPLICATIONS

Compact portable devices "Cellular phones, DVD, DSC, etc"

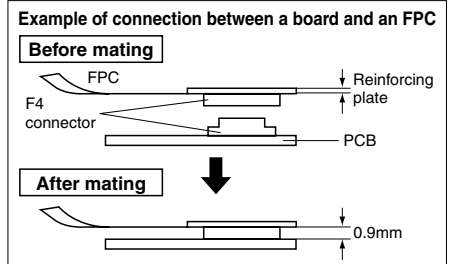

ORDERING INFORMATION

AXK [] [] [] [] [] [] G

AXK: Narrow Pitch Connector Series

Series name;

7L: F4 (0.4 mm pitch) Socket

8L: F4 (0.4 mm pitch) Header

Number of contacts (2 digits)

Mated height

<Socket>

2: For mated height 0.9 mm

<Header>

1: For mated height 0.9 mm

Functions

2: Without positioning bosses

Surface treatment (Contact portion / Terminal portion)

<Socket>

7: Ni plating on base, Au plating on surface (for Ni barrier available)

<Header>

5: Ni plating on base, Au plating on surface

Other specifications

<Header>

B: Soldering terminals with fork type terminal^{Note}

Packing

G: 3,000 pieces embossed tape and plastic reel × 2

Note: "B" in the 11th digit of the header part number signifies a fork type soldering terminals to lessen the constraint on amount of solder when mounting, and a construction that makes it difficult when mounting for excess solder to interfere with the socket.

Although compatible with the previous parts, these parts are not compatible with the recommended PC board pattern and recommended metal mask pattern.

PRODUCT TYPES 

Mated height	Number of contacts	Part number		Packing	
		Socket	Header	Inner carton (1 reel)	Outer carton
0.9 mm	10	AXK7L10227G	AXK8L10125BG	3,000 pieces	6,000 pieces (2 reels)
	12	AXK7L12227G	AXK8L12125BG		
	14	AXK7L14227G	AXK8L14125BG		
	16	AXK7L16227G	AXK8L16125BG		
	20	AXK7L20227G	AXK8L20125BG		
	22	AXK7L22227G	AXK8L22125BG		
	24	AXK7L24227G	AXK8L24125BG		
	26	AXK7L26227G	AXK8L26125BG		
	28	AXK7L28227G	AXK8L28125BG		
	30	AXK7L30227G	AXK8L30125BG		
	32	AXK7L32227G	AXK8L32125BG		
	34	AXK7L34227G	AXK8L34125BG		
	36	AXK7L36227G	AXK8L36125BG		
	38	AXK7L38227G	AXK8L38125BG		
	40	AXK7L40227G	AXK8L40125BG		
	44	AXK7L44227G	AXK8L44125BG		
	48	AXK7L48227G	AXK8L48125BG		
	50	AXK7L50227G	AXK8L50125BG		
54	AXK7L54227G	AXK8L54125BG			
60	AXK7L60227G	AXK8L60125BG			
66	AXK7L66227G	AXK8L66125BG			
70	AXK7L70227G	AXK8L70125BG			
80	AXK7L80227G	AXK8L80125BG			

- Notes: 1. Regarding ordering units;
 During production: Please make orders in 1-reel units.
 Samples for mounting confirmation: Available in units of 50 pieces. Please contact us.
 Samples: Available. Please contact us.
2. The above part numbers are for connectors without positioning bosses, which are standard. When ordering connectors with positioning bosses, please contact our sales office.
3. Please contact us regarding different number of contacts.
4. "B" in the 11th digit of the header part number signifies a fork type soldering terminals to lessen the constraint on amount of solder when mounting, and a construction that makes it difficult when mounting for excess solder to interfere with the socket.
 Although compatible with the previous parts, these parts are not compatible with the recommended PC board pattern and recommended metal mask pattern.

SPECIFICATIONS

1. Characteristics

	Item	Specifications	Conditions
Electrical characteristics	Rated current	0.3A/terminal (Max. 5 A at total terminals)	—
	Rated voltage	60V AC/DC	—
	Breakdown voltage	150V AC for 1 min.	Rated voltage is applied for one minute and check for short circuit or damage with a detection current of 1mA
	Insulation resistance	Min. 1,000MΩ (Initial)	Using 250V DC megger (applied for 1 min.)
	Contact resistance	Max. 90mΩ	Based on the contact resistance measurement method specified by JIS C 5402.
Environmental characteristics	Ambient temperature	-55°C to +85°C	No freezing at low temperatures
	Soldering heat resistance	Max. peak temperature of 260°C (on the surface of the PC board around the connector terminals) 300°C within 5 sec, 350°C within 3 sec.	Infrared reflow soldering Soldering iron
	Storage temperature	-55°C to +85°C (Product only) -40°C to +50°C (Emboss packing)	No freezing at low temperatures
	Thermal shock resistance (header and socket mated)	5 cycles, insulation resistance min. 100MΩ, contact resistance max. 90mΩ	Sequence 1. -55 [±] 3°C, 30 min. 2. ~, Max. 5 min. 3. 85 [±] 3°C, 30 min. 4. ~, Max. 5 min.
	Humidity resistance (header and socket mated)	120 hours, insulation resistance min. 100MΩ, contact resistance max. 90mΩ	Temperature 40±2°C, humidity 90 to 95% R.H.
	Saltwater spray resistance (header and socket mated)	24 hours, insulation resistance min. 100MΩ, contact resistance max. 90mΩ	Temperature 35±2°C, saltwater concentration 5±1%
	H ₂ S resistance (header and socket mated)	48 hours, contact resistance max. 90mΩ	Temperature 40±2°C, gas concentration 3±1 ppm, humidity 75 to 80% R.H.
Lifetime characteristics	Insertion and removal life	50 times	Repeated insertion and removal speed of max. 200 times/hours
Unit weight		40 contacts; Socket: 0.05g Header: 0.03g	—

AXK7L, 8L

2. Material and surface treatment

Part name	Material	Surface treatment
Molded portion	LCP resin (UL94V-0)	—
Contact/Post	Copper alloy	Contact portion: Ni plating on base, Au plating on surface Terminal portion: Ni plating on base, Au plating on surface (Except for front edge of terminal) However, the area adjacent to the socket terminal is exposed to Ni on base. Metal clips: Ni plating on base, Sn plating on surface (Socket: except for front edge of the terminal)

DIMENSIONS (unit: mm)

The CAD data of the products with a **CAD Data** mark can be downloaded from: <http://panasonic-electric-works.net/ac>

• Socket (Mated height 0.9 mm)

CAD Data

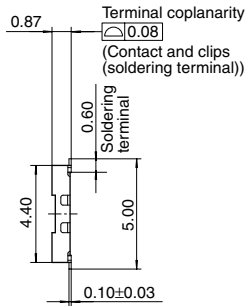
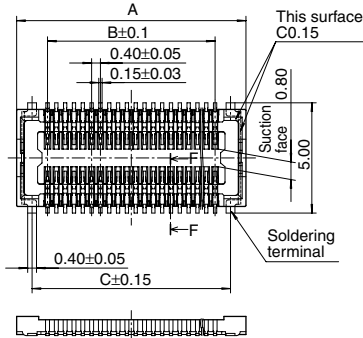

F-F cross section

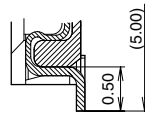

General tolerance: ±0.2

Dimension table (mm)

Number of contacts/ Dimensions	A	B	C
10	4.4	1.6	3.0
12	4.8	2.0	3.4
14	5.2	2.4	3.8
16	5.6	2.8	4.2
20	6.4	3.6	5.0
22	6.8	4.0	5.4
24	7.2	4.4	5.8
26	7.6	4.8	6.2
28	8.0	5.2	6.6
30	8.4	5.6	7.0
32	8.8	6.0	7.4
34	9.2	6.4	7.8
36	9.6	6.8	8.2
38	10.0	7.2	8.6
40	10.4	7.6	9.0
44	11.2	8.4	9.8
48	12.0	9.2	10.6
50	12.4	9.6	11.0
54	13.2	10.4	11.8
60	14.4	11.6	13.0
66	15.6	12.8	14.2
70	16.4	13.6	15.0
80	18.4	15.6	17.0

• Header (Mated height: 0.9 mm)

CAD Data

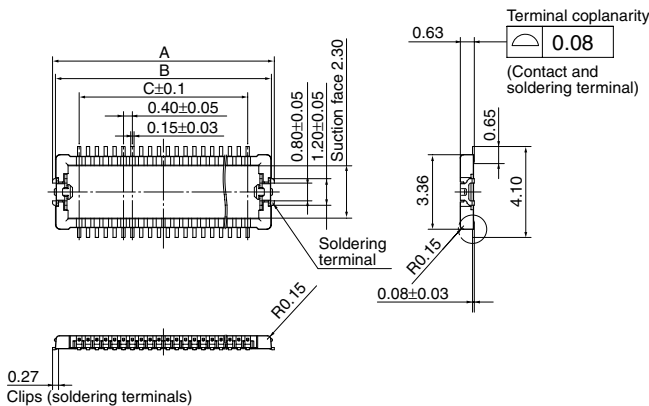

General tolerance: ±0.2

Dimension table (mm)

Number of contacts/ Dimensions	A	B	C
10	4.0	3.74	1.6
12	4.4	4.14	2.0
14	4.8	4.54	2.4
16	5.2	4.94	2.8
20	6.0	5.74	3.6
22	6.4	6.14	4.0
24	6.8	6.54	4.4
26	7.2	6.94	4.8
28	7.6	7.34	5.2
30	8.0	7.74	5.6
32	8.4	8.14	6.0
34	8.8	8.54	6.4
36	9.2	8.94	6.8
38	9.6	9.34	7.2
40	10.0	9.74	7.6
44	10.8	10.54	8.4
48	11.6	11.34	9.2
50	12.0	11.74	9.6
54	12.8	12.54	10.4
60	14.0	13.74	11.6
66	15.2	14.94	12.8
70	16.0	15.74	13.6
80	18.0	17.74	15.6

• Socket and header are mated

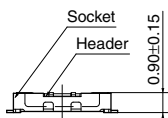

EMBOSSED TAPE DIMENSIONS (unit: mm) (Common for respective contact type, socket and header)

Tape dimensions (Conforming to JIS C 0806-1990. However, some tapes have mounting hole pitches that do not comply with the standard.)

Plastic reel dimensions (Conforming to EIAJ ET-7200B)

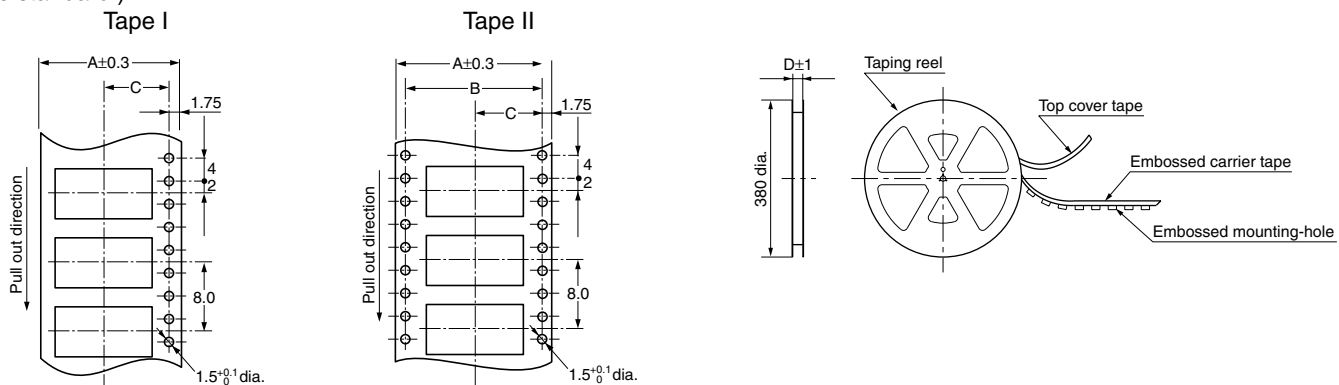
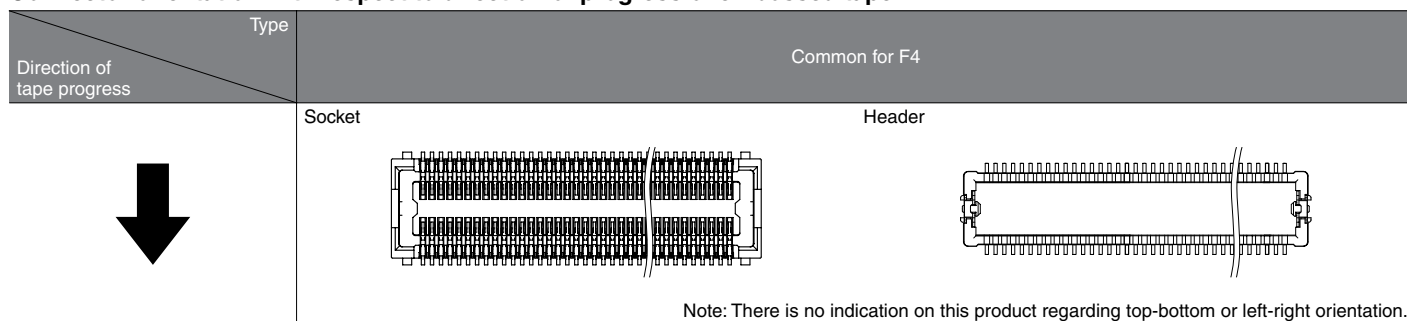

TABLE OF DIMENSIONS

Mated height	Number of contacts	Type of taping	A	B	C	D	Quantity per reel
Common for socket and header: 0.9mm	Max. 24	Tape I	16.0	—	7.5	17.4	3000
	26 to 70	Tape I	24.0	—	11.5	25.4	3000
	80	Tape II	32.0	28.4	14.2	33.4	3000

Connector orientation with respect to direction of progress of embossed tape





Socket



Header

Compliance with RoHS Directive

FEATURES

1. 3,000 insertion and removals (when as recommended)

From the 50 insertion and removals of standard type, up to 3,000 insertion and removals (with recommended insertion and removal) are possible for use in inspection.

Ideal for inspection of module units and inspection during the device assembly process

2. Same external dimensions and foot pattern as standard type.

Since shape is the same as standard type, inspection is possible without interfering with devices in the vicinity of standard connectors.

3. Easier to mate

The connector is designed for inspection purpose only that retention force is not strong enough to sustain each side.

Cautious approaches are required when it comes to handling the mated connectors to avoid sudden fall.

The mated connectors are fragile against shocks and vibrations that they should be treated with special attention.

4. Lead free

TABLE OF PRODUCT TYPES

☆: Available for sale

Product name	F4 for inspection
10	☆
12	☆
14	☆
16	☆
20	☆
22	☆
24	☆
26	☆
28	☆
30	☆
32	☆
34	☆
36	☆
38	☆
40	☆
44	☆
48	☆
50	☆
54	☆
60	☆
66	☆
70	☆
80	☆

Number of contacts

Notes:

1. Please inquire about numbers of contacts other than those given above.
2. Please inquire with us regarding delivery times.
3. Please keep the minimum unit for ordering no less than 50 pieces per lot.
4. Please inquire for further information.

PRODUCT TYPES

Specifications		Part No.	Specifications		Part No.
Socket	Without positioning bosses	AXK7LE**26G	Header	Without positioning bosses	AXK8LE**26BG

Notes: 1. When placing an order, substitute the "*" (asterisk) in the above part number with the number of contacts for the required connector.

2. The above part numbers are for connectors without positioning bosses, which are standard. When ordering connectors with positioning bosses, please contact our sales office.

NOTES

1. Removal by pulling up from an end causes the entire connector removal force to concentrate on the soldering terminals and end terminals. Therefore, please lift and remove from the side. Doing so will also prevent cracking of the soldered parts.

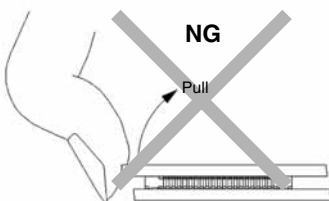
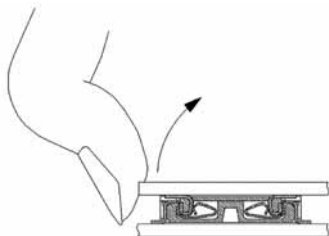

2. PC Boards and Recommended Metal Mask Patterns

Connectors are mounted with high density, with a pitch interval of 0.4 to 0.5 mm.

In order to reduce solder bridge and other issues make sure the proper levels of solder are used.

The figures to the right are recommended metal mask patterns. Please use them as a reference.

In particular, if a lot of solder is used in the header retaining soldering terminals, it might interfere with and cause incomplete socket mating. Therefore, please follow the recommended conditions give on the right.

Socket

Recommended PC board pattern
(Mount pad arrangement pattern)

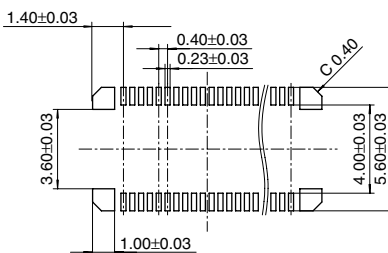

Recommended metal mask pattern

Metal mask thickness: Here, 150 μm
(Terminal portion opening area ratio: 53 %)
(Metal portion opening area ratio: 100 %)

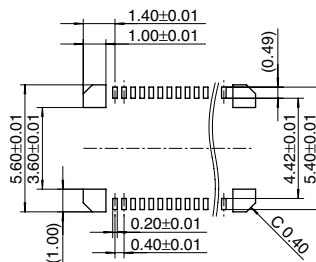

Recommended metal mask pattern

Metal mask thickness: Here, 120 μm
(Terminal portion opening area ratio: 66 %)
(Metal portion opening area ratio: 100 %)

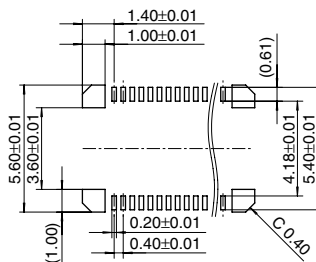

Header

Recommended PC board pattern
(Mount pad arrangement pattern)

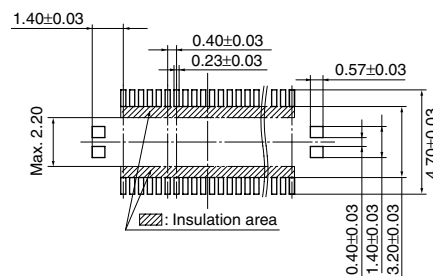

Relation between connector and mounting pad

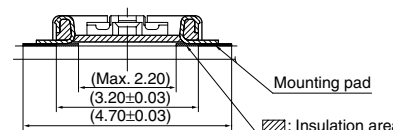

Recommended metal mask pattern

Metal mask thickness: Here, 150 μm
(Terminal portion opening area ratio: 52 %)
(Metal portion opening area ratio: 80 %)

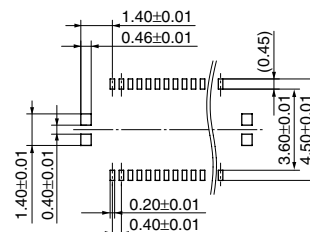

Recommended metal mask pattern

Metal mask thickness: Here, 120 μm
(Terminal portion opening area ratio: 66 %)
(Metal portion opening area ratio: 100 %)

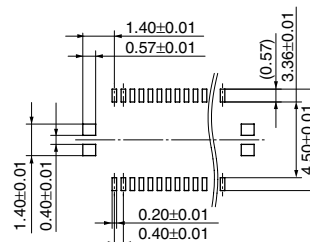

For other details, please verify with the product specification sheets.

Mouser Electronics

Authorized Distributor

Click to View Pricing, Inventory, Delivery & Lifecycle Information:

Panasonic:

[AXK8L16125BG](#) [AXK8L14115BG](#) [AXK8L66115BG](#) [AXK8L66125BG](#) [AXK8LE1816BG](#) [AXK8LE1826BG](#)
[AXK8LE4216BG](#) [AXK8LE4226BG](#) [AXK8LE4616BG](#) [AXK8LE4626BG](#) [AXK8LE5216BG](#) [AXK8LE5226BG](#)
[AXK8LE5616BG](#) [AXK8LE5626BG](#) [AXK8LE5816BG](#) [AXK8LE5826BG](#) [AXK8LE6216BG](#) [AXK8LE6226BG](#)
[AXK8LE6416BG](#) [AXK8LE6426BG](#) [AXK8LE6816BG](#) [AXK8LE6826BG](#) [AXK8LE7216BG](#) [AXK8LE7226BG](#)
[AXK8LE7416BG](#) [AXK8LE7426BG](#) [AXK8LE7616BG](#) [AXK8LE7626BG](#) [AXK8LE7816BG](#) [AXK8LE7826BG](#)
[AXK8LE82216BG](#) [AXK8LE82226BG](#) [AXK7L10217G](#) [AXK7L10227G](#) [AXK7L12217G](#) [AXK7L12227G](#) [AXK7L14227G](#)
[AXK7L16217G](#) [AXK7L16227G](#) [AXK7L20217G](#) [AXK7L20227G](#) [AXK7L22217G](#) [AXK7L22227G](#) [AXK7L24217G](#)
[AXK7L24227G](#) [AXK7L26217G](#) [AXK7L26227G](#) [AXK7L28217G](#) [AXK7L28227G](#) [AXK7L30217G](#) [AXK7L30227G](#)
[AXK7L32217G](#) [AXK7L32227G](#) [AXK7L34217G](#) [AXK7L34227G](#) [AXK7L36217G](#) [AXK7L36227G](#) [AXK7L38217G](#)
[AXK7L38227G](#) [AXK7L40217G](#) [AXK7L40227G](#) [AXK7L44217G](#) [AXK7L44227G](#) [AXK7L48217G](#) [AXK7L48227G](#)
[AXK7L50217G](#) [AXK7L50227G](#) [AXK7L54217G](#) [AXK7L54227G](#) [AXK7L60217G](#) [AXK7L60227G](#) [AXK7L70217G](#)
[AXK7L70227G](#) [AXK7L80217G](#) [AXK7L80227G](#) [AXK8L10115BG](#) [AXK8L10125BG](#) [AXK8L12115BG](#) [AXK8L12125BG](#)
[AXK8L14125BG](#) [AXK8L16115BG](#) [AXK8L20115BG](#) [AXK8L20125BG](#) [AXK8L22115BG](#) [AXK8L22125BG](#)
[AXK8L24115BG](#) [AXK8L24125BG](#) [AXK8L26115BG](#) [AXK8L26125BG](#) [AXK8L28115BG](#) [AXK8L28125BG](#)
[AXK8L30115BG](#) [AXK8L30125BG](#) [AXK8L32115BG](#) [AXK8L32125BG](#) [AXK8L34115BG](#) [AXK8L34125BG](#)
[AXK8L36115BG](#) [AXK8L36125BG](#) [AXK8L38115BG](#)