

1 2 3 4 5 6 7

A  
B  
C  
D  
E  
F  
G  
H

A  
B  
C  
D  
E  
F  
G  
H

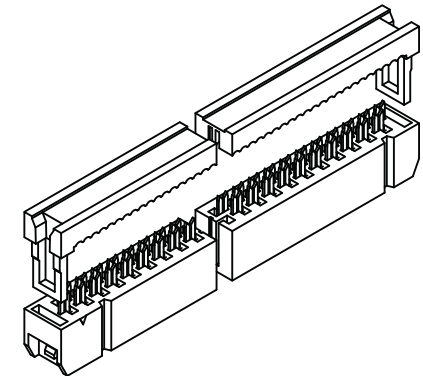
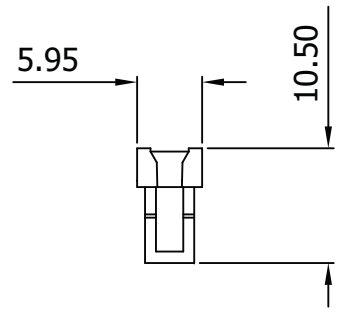
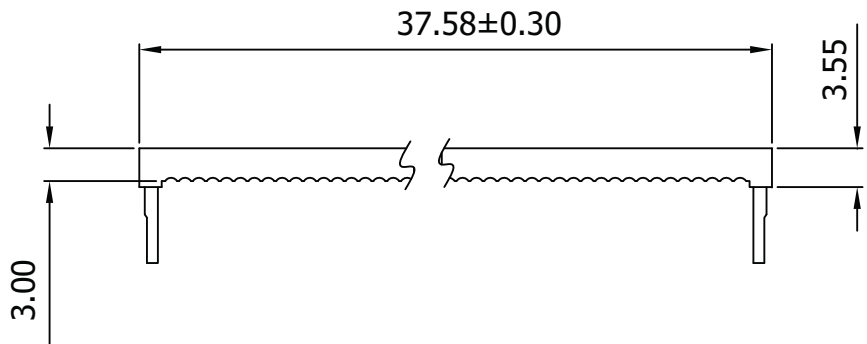

DIMENSION

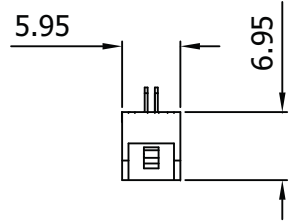
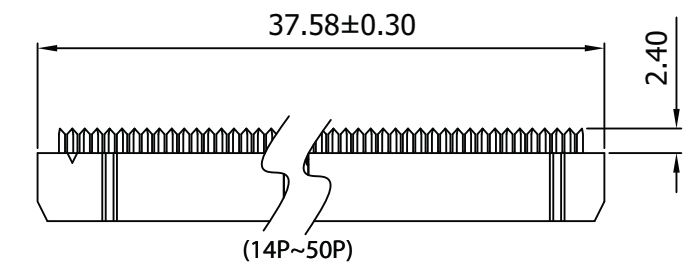

**Material:**

- Insulator: P.B.T. 30% Glass Fiber, UL 94V-0
- Contact Material: Phosphor Bronze, Gold flash over Nickel

**Electrical:**

- Current Rating: 1Amp DC
- Insulation Resistance: 3,000MΩ Min.
- Contact Resistance: 30MΩ Max.
- Dielectric Withstanding: 500V AC
- Operating Temperature: -40°C ~ +105°C
- Terminated with 1.27MM pitch flat ribbon cable.

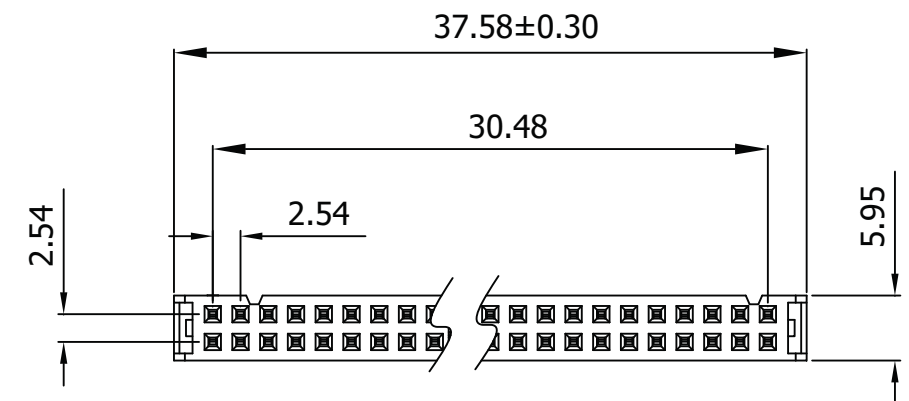

Unit: MM±0.20MM

Scale	1:1						Name
TOLERANCE						Drawn	10.19.11
X.X	±0.40					Approved	Chappell
X.XX	±0.25						
X.XXX	±0.15						
Angle	±3°						
Modification		Date		Name			

Item No.		<b>AWP26-8240-T-R</b>
Title		
Drawing No.		<b>rev00</b>
Replace		



1 2 3 4 5 6 7