

Prelim. Specification

HBO11A-48-28, HBO11A-48-28N

48Vin 28Vout 11A

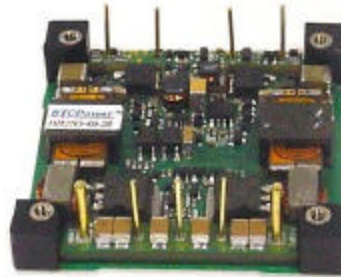

Description

The HBO11A-48-28 of low cost half brick DC/DC converters are comparable to existing half-bricks. They are targeted specifically at the telecommunication, industrial electronics, mobile telecommunication and distributed power markets. With a wide input voltage range of 36-75V they are available with output voltage of either 1.8, 2.5, 3.3, 5.0, 12, 15, 24 or 28 Volts. All models feature an input filter, input undervoltage lockout, output overvoltage and overtemperature protection, output current limiting and short circuit protection. The unique open-frame construction with aluminum heat spreader design achieves efficient heat transfer with no hot spots.

Applications

- Telecommunications
- Data Communications
- Wireless Communications
- Networking Gear
- Servers, Switches and Data Storage
- Semiconductor Test Equipment
- Distributed Power Architecture

Features

- Delivers up to 11A in half brick
- No minimum load required
- Low profile of only 0.36 inch
- 1.8V, 2.5V, 3.3V, 5.0V, 12V, 15V, 24V or 28V output models
- Wide input operating range 36-75V
- -40°C to +100°C ambient operation
- On/Off pin and remote sense
- Output adjustment +10% and -10% range
- 1500V, 10M input-to-output isolation
- Meets Basic Insulation requirements of EN60950
- UL 1950 recognized, TUV EN60950 and CSA C22.2 No. 60950-00 Certified (pending)
- Meets conducted limits of FCC Class B and CEI IEC61204-3 Class B with external filter
- MTBF of 1,000,000 hours @ 50°C (Bellcore)

CONVERTER SELECTION

Typical @ T_a=+25°C under nominal line voltage and 75% load conditions, unless noted.

Model		Input				Output		Efficiency
Part Number		Voltage (Volts)		Current (A)		Voltage	Current	75% Load
Positive Logic	Negative Logic	Nominal	Range	No load	Full load	(Volts)	(Amps)	(%)
HBO11A-48-28	HBO11A-48-28N	48	36-75	0.1	7.2	28	11	90

For encapsulated (epoxy enclosed) models, replace "HBO" in part no. with "HBP".

Consult factory for other output voltage configurations.

Outline and Pin-out Information

Pin Connection	
Pin#	Function
1	Vin +
2	On/Off
3	Case
4	Vin -
5	Vout -
6	Sense -
7	Trim
8	Sense +
9	Vout +

All dimensions are in inches [mm]
 Pin 5 and 9 are dia. 0.08 [2.03]
 All other pins are all dia. 0.040 [1.02]
 Pin material: Brass
 Pin finish: Tin/Lead plated
 Heat spreader (baseplate) material: Aluminum
 Weight: 60.5g

Tolerance	
Inches	Millimeters
•XX ± 0.020	•X ± 0.5
•XXX ± 0.010	•XX ± 0.25
Pin: ± 0.002	± 0.05

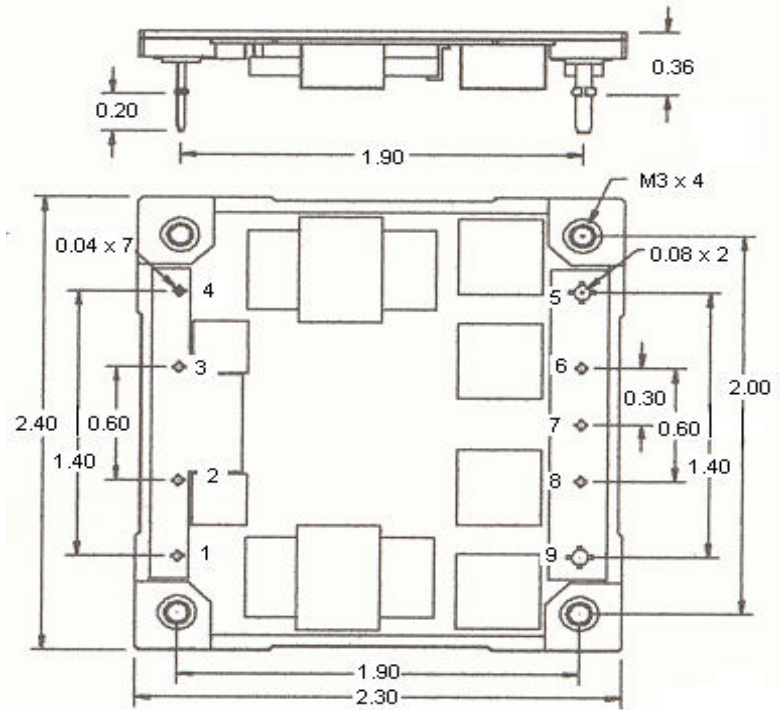

The information and specifications contained in this specification are believed to be accurate and reliable at the time of publication. Specifications are subject to change without notice.

Electrical Specification

Typical test data at Ta=25°C, Vin=48V unless otherwise noted.

PARAMETER	NOTES	MIN	TYP	MAX	UNIT
Absolute maximum rating					
Input voltage		0		80	V
Operating case temperature		-40		100	°C
Storage temperature		-40		105	°C
Humidity				95	%
Input characteristics					
Operating input voltage range		36		75	V
Turn on voltage threshold		35	35.4	35.8	V
Turn off voltage threshold		34	34.4	34.8	V
Off converter input current	36Vin		6		mA
Output characteristics					
Output voltage					
HBO11A-48-28 or HBO11A-48-28N	36-75Vin, no load to full load	27.5	28.0	28.5	V
Line regulation	36-75Vin,		0.2	0.3	%
Load regulation	36-75Vin, 10~100% load		0.2	0.3	%
Output current					
HBO11A-48-28 or HBO11A-48-28N		0		11	A
Output voltage trim range	Percentage of normal output	-10		+10	%
Output voltage ripple and noise	20Mz bandwidth, 100% Load, 48Vin		70	100	mV(pk-pk)
Output over power protection		110	120	140	%
Over-voltage protection		115		130	%
Over-temperature protection			105	110	°C
Temperature coefficient				±0.05	%/°C
Output dynamic characteristics					
Startup time	5% to 95% of the output voltage		10	20	ms
Transient recovery time	25% load change (1.0A/us)		300	500	µs
Transient Peak	25% load change (1.0A/us)		300	400	mv
Efficiency					
HBO11A-48-28 or HBO11A-48-28N			89		%
Isolation characteristics					
Isolation voltage(primary to secondary)	1minute		1500		VDC
Isolation voltage (primary to case)	1minute		1000		VDC
Isolation voltage (secondary to case)	1minute		1000		VDC
Isolation resistance	500VDC, Primary to secondary	10			MΩ
Isolation voltage (secondary to case)	1minute		1000		VDC
Feature Characteristics					
Switching frequency		280	300	320	KHz
ON/OFF control (Positive logic)					
Converter On		2.5		7	V
Converter Off	HBO11A-48-28	-1.0		0.5	V
ON/OFF control (Negative logic)					
Converter On		-1.0		0.5	V
Converter Off	HBO11A-48-28N	2.5		7	V
Calculated MTBF	Bellcore @ 50°C		3,000,000		Hrs
Weight			51		g

Basic operation and functions

The **HBO / HBP family** uses planar transformer technology to achieve high output current. The whole unit switches at the fixed frequency for a predictable EMI performance. The **HBO / HBP Brick** has many standard controls and protection functions.

Input Power (pin1, pin4)

Input power $V_{in}(+)$ must be connected to Positive input voltage pin1; Input power $V_{in}(-)$ must be connected to Negative input voltage pin4.

Output Power (pin9, pin5)

Output power $V_{out}(+)$ must be connected to Positive output voltage pin9; Output power $V_{out}(-)$ must be connected to Negative output voltage pin5.

On/Off (pin 2)

Permits the user to maintain unit On/Off, in order to properly sequence different power supplies and reduce power consumption during the standby condition. There are two remote control options available, positive logic and negative logic is referenced to $V_{in}(-)$, and typical connections are shown in Fig 1.

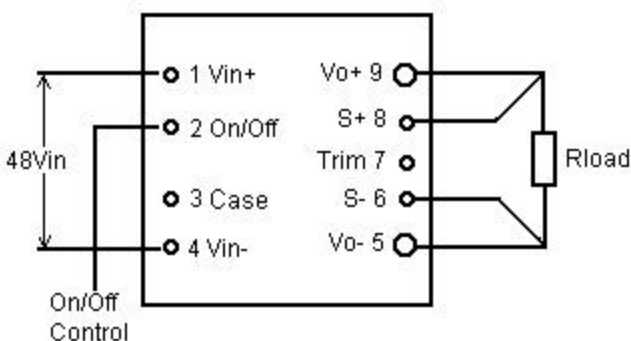

Fig. 1: Typical Circuit for On/Off Function

Pin 2 is the "Enable" pin, connecting a TTL compatible pin. A TTL control signal to this pin, according to the specification, will turn the unit on or off.

The positive logic version turns on when pin 2 is at logic high, and turns off when pin 2 is at logic low. The unit is on when pin 2 is left open.

The negative logic version turns on when pin 2 is at logic low and turns off when pin 2 is at logic high. The pin 2 can be directed to $V_{in}(-)$, to enable automatic turn on to the unit without the need of an external control signal.

Remote Sense (pin 8, pin 6)

Permits the user to maintain the accurate output voltage at the remote load terminals regardless of the line drop.

The Sense(-) (pin6) and Sense(+) (pin8) should be connected at the load or at the point where the regulation is needed. (shown on Fig. 2)

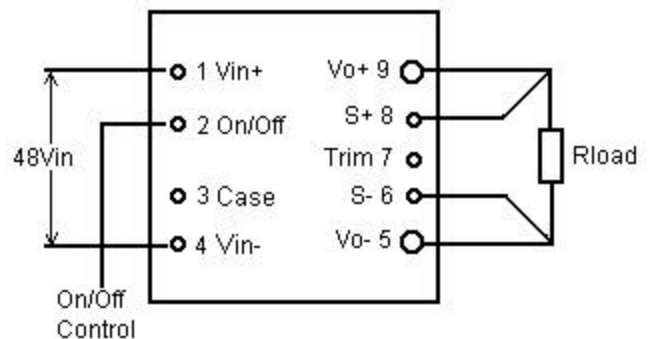

Fig 2: Remote Sense Circuit

The remote sense feature of the unit compensates for voltage drop occurring between the output pins of the unit and load. The Sense(-) (pin5) and Sense(+)(pin7) should be connected at the load or at the point where regulation is required.

If remote Sense is not required, the Sense(-) pin must be connected to the Vout(-) pin (pin5), and the Sense(+) pin must be connected to the Vout(+) pin(pin 9) to ensure the unit will regulate at the specified output voltage. If these connections are not made, the unit's output voltage will be higher than the specified value.

The unit output over voltage protection senses the voltage across Vout(+) and Vout(-), and not across the sense lines, so the resistance between the output pins of the unit and the load should be minimized to prevent unwanted triggering of the OVP.

When using the remote sense feature, the output voltage at the unit can be increased by as much as 10% above the normal rating, in order to maintain the required voltage across the load. Therefore, the designer must consider this condition.

Also when using the remote sense function, the output power must be taken care of, as not to exceed the maximum power capability of the unit.

Output Voltage Trim (pin 7)

Permits the user to adjust the output voltage up or down to achieve the custom voltage or to make the output voltage margining. The adjustment range is from + 10% to -10%.

Output voltage can be adjusted up or down, by connecting the Rtrim-up or Rtrim-down resistor as shown. Rtrim-up makes the output voltage go up to 10%; and the Rtrim-down makes the output voltage go down to 10%.

Leave Trim pin (Pin 7) open for normal output voltage.

When trimming up, care must be taken, not to exceed the unit OVP threshold. A typical circuit is shown in Fig. 3.

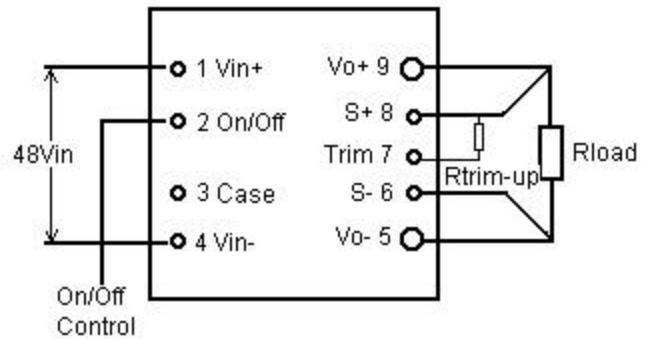

Fig 3. Trim Up Output Voltage Circuit

Trimming down the output voltage for a typical circuit, as shown on Fig. 4.

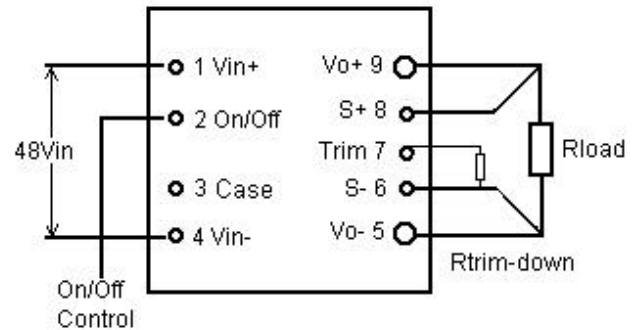

Fig 4. Trim Down Output Voltage Circuit

Protection Features

Input Under-voltage lockout (IUV)

Input under voltage (IUV) is standard with the HBO / HBP unit. The unit will shut down when the input voltage drops below a threshold, and the unit will turn on when the input voltage goes to the upper threshold.

The hysteric voltage of the under voltage protection is 1V, normally from the 34.5V to 35.4V range.

Output Over-current Protection (OCP)

The unit will shut down when the over current or short circuit condition exists.

Once the OCP happens, the unit has shut down. The attempted restart will continue indefinitely

until the over current or short circuit condition is removed. When OCP happens, the output voltage drops below 0.8V.

Input voltage has almost no effect on the current limit point.

Output Over-voltage Protection (OVP)

The unit will shut down when the output voltage exceeds the over voltage threshold.

If the output voltage across Vout(+) (pin9) and Vout(-) (pin5) exceeds the threshold of the OVP circuitry, the unit has shut down which is caused by an OVP circuit, and the unit will never restart, and the output voltage is below 0.5V.

Over Temperature Protection (OTP)

The unit will shut down when the base plate temperature exceeds the protection threshold.

The unit will shut down under the base plate temperature over a 105°C condition to protect the unit from overheating. The OTP circuit will turn the unit off when OTP happens. Once the unit has shut down, it will restart at the cycle when the base plate temperature goes down.

Application information

Input Source Impedance

The unit has been designed to be stable with no external capacitors when used in a low inductance input and output circuit.

However in many applications, the inductance with the distribution from the power source to the input of the unit can affect the stability of the unit. The addition of 100uF electrolytic capacitor with an $Esr < 1\Omega$ (at 100khz) across the input can ensure the stability of the unit. Also in many applications, the user has to use decoupling capacitors at the output load, to ensure the hold up time for the load.

Safety Requirements and Considerations

The unit meets the American and International safety regulatory requirement UL1950. Basic insulation is also provided between the input side and the output side.

To meet safety agencies requirements, an input line fuse must be used external to the unit. An 15A fuse or less with a normal blow rate must be used to meet the safety agencies requirements. A minimum 42LFM airflow should also be provided if the unit is intended to operate at full power without heatsink.

If the input source is non-SELV (ELV or a hazardous voltage greater than 60 Vdc and less than or equal to 75 Vdc), for the unit output to be considered meeting the requirements of safety extra low voltage (SELV), all of the following must be met:

- The input source is to be provided with reinforced insulation from any hazardous voltage, including the ac main.
- The input pins of the unit are not operator accessible.
- For whole system, for safety agencies requirements, and for the combination of the unit's input side (primary side) and the unit's output side (secondary side), verify that under a single fault, hazardous voltages do not appear at the unit's output side (secondary side).
- Never ground either of the input pins of the unit without grounding one of the output pins. This may allow a non-SELV voltage to appear between the output pin and ground.