

Alle Rechte vorbehalten/ All rights reserved

Y
(Lochbild)
(board drillings)

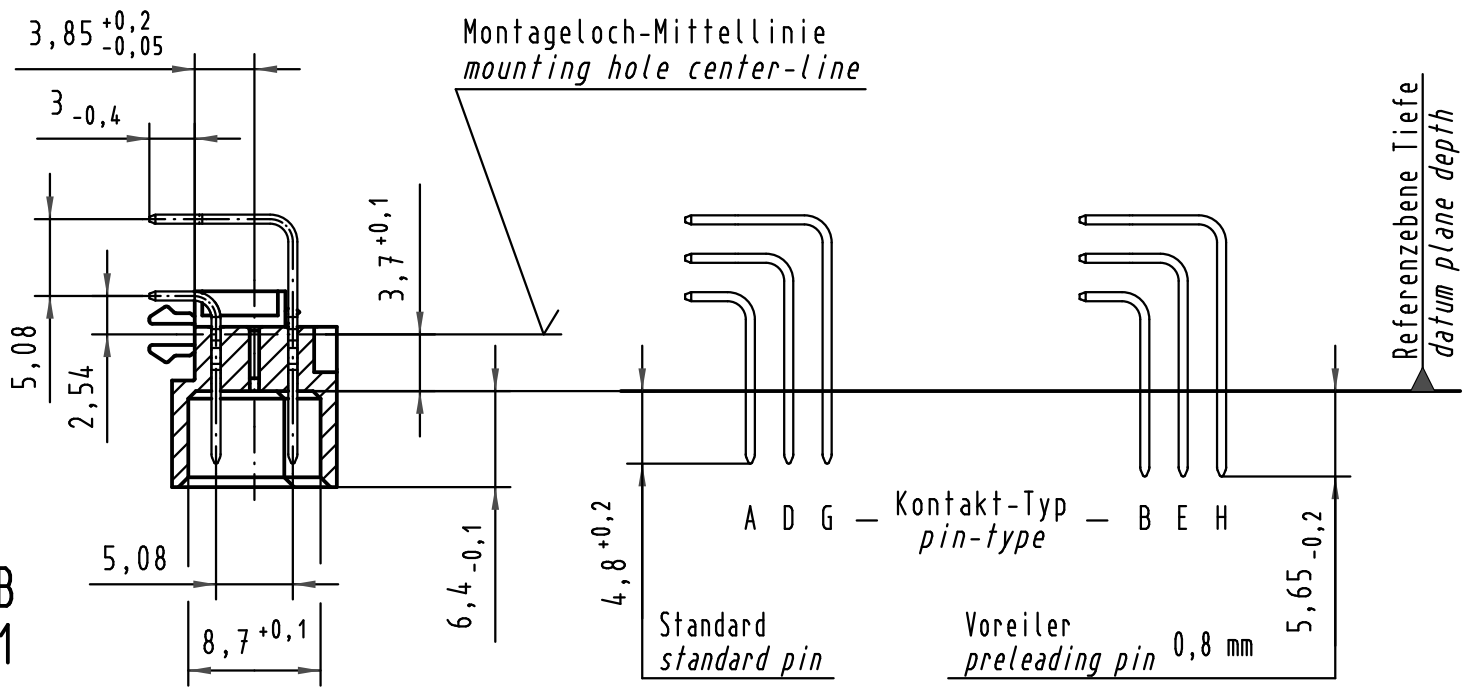
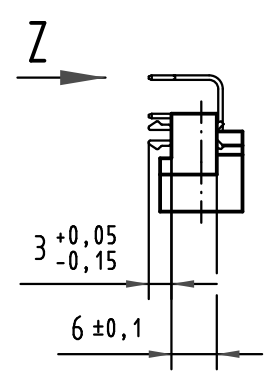
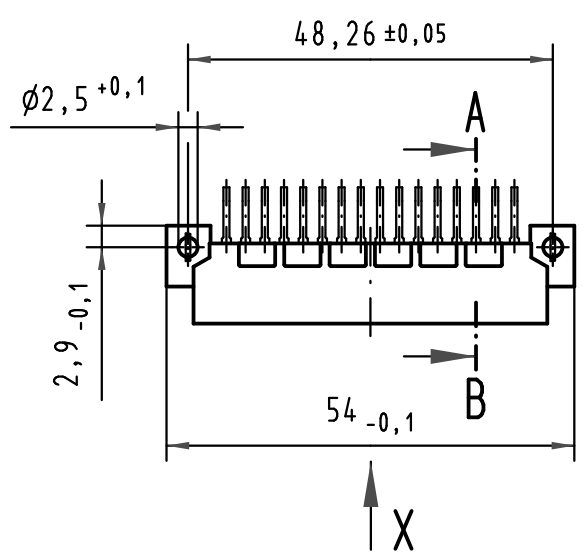
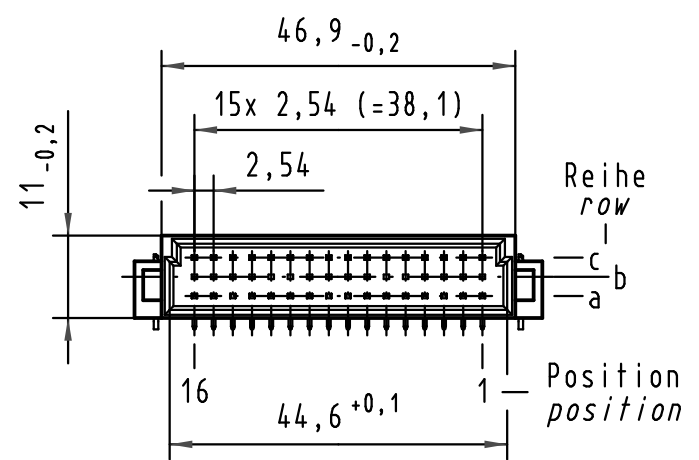
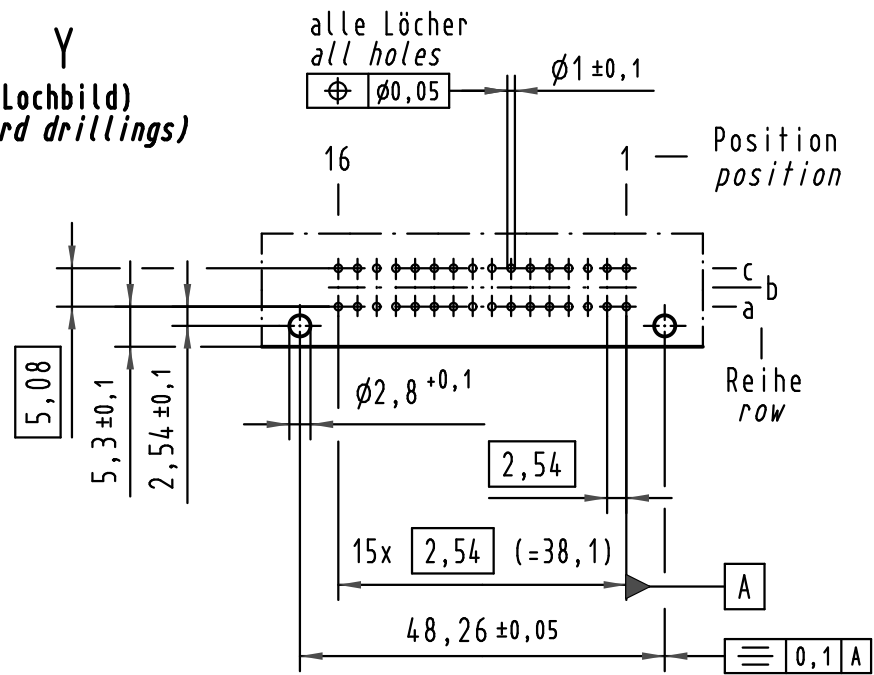

A-B
2:1

X Kontaktbelegung
contact loading

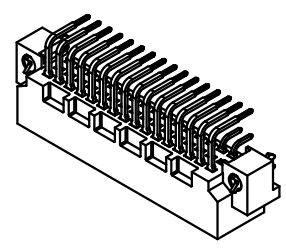
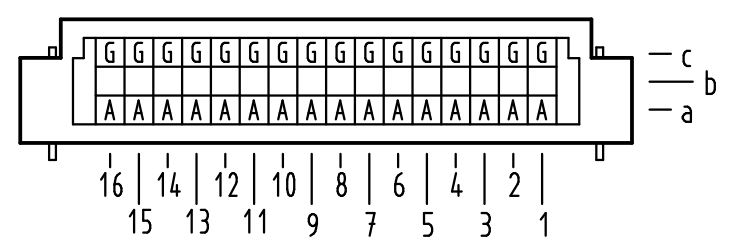

09 23 332 6919	2	Au über/over Ni
09 23 332 2919	1	Au über/over Ni
Bestell-Nr. part-no.	Anforderungsstufe nach IEC performance level acc. to IEC	Kontaktoberfläche contact plating

Z
10:1

Querschnitt der
Lötanschlüsse:
cross-section of
solder terminations:

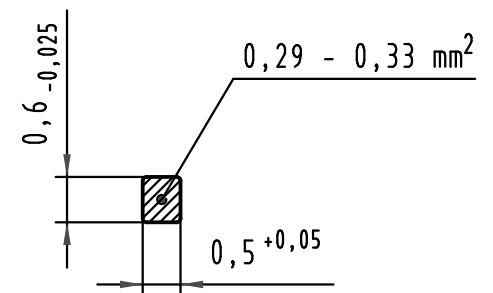

All Dimensions in mm Original Size DIN A 3		
Mod.	Dat.	Name
34650	13.12.07	Hage.
30797	25.01.02	Rie.
28048		

Techn. Character.		
	Dat.	Name
	02.08.00	Rie.
	02.08.00	Pa.
HARTING Electronics GmbH & Co. KG D-32339 ESPELKAMP		

Nicht tolerierte Maßel/Free size tolerances IEC 60603-2	
Bauform 2C Messerleiste mit Clip Einlöt, 32 pol., SMC (Hochtemperatur) type 2C male connector with clip solder, 32 pol., SMC (high temperature)	
TB 09 23 332 x919	Blatt/ page
Sub.	