

Surface Mount High Performance AlInGaP LED Indicators

Technical Data

SunPower Series
HSMA-TX25
HSMD-TX25
HSMJ-TX25

Features

- **Outstanding LED Material Efficiency**
- **Exceptional Light Output Over a Wide Range of Drive Currents**
- **Colors: 590 nm Amber, 603 nm Orange, and 615 nm Reddish-Orange**
- **Compatible with Automatic Placement Equipment**
- **Compatible with Convective IR, Vapor Phase Reflow, and TTW Solder Processes**
- **Packaged in 12 mm or 8 mm Tape on 7" or 13" Diameter Reels**
- **EIA Standard Package**
- **Low Package Profile**
- **Non-diffused Package Excellent for Backlighting and Coupling to Light Pipes**

Description

The LED material used in these devices is the very efficient absorbing Substrate aluminum indium gallium phosphide (AS AlInGaP), capable of producing high light output over a wide range of drive currents.

These solid state surface mount indicators are designed with a flat top and sides to be easily handled by automatic placement equipment. A glue pad is provided for adhesive mounting processes. They are compatible with convective IR and vapor phase reflow soldering, through the wave (TTW) soldering, and conductive epoxy attachment processes.

The package size and configuration conform to the EIA-535



BAAC standard specification for case size 3528 tantalum capacitors. The folded leads permit dense placement and provide an external solder joint for ease of inspection.

These devices are non-diffused, providing high intensity for applications such as backlighting, light pipe illumination, and front panel indication.

Device Selection Guide

Amber $\lambda_d = 590 \text{ nm}$	Orange $\lambda_d = 603 \text{ nm}$	Reddish-Orange $\lambda_d = 615 \text{ nm}$	Description
HSMA-T425	HSMD-T425	HSMJ-T425	12 mm Tape, 7" Reel, 2000 Devices
HSMA-T525	HSMD-T525	HSMJ-T525	12 mm Tape, 13" Reel, 8000 Devices
HSMA-T625	HSMD-T625	HSMJ-T625	8 mm Tape, 7" Reel, 2000 Devices
HSMA-T725	HSMD-T725	HSMJ-T725	8 mm Tape, 13" Reel, 8000 Devices

Package Dimensions

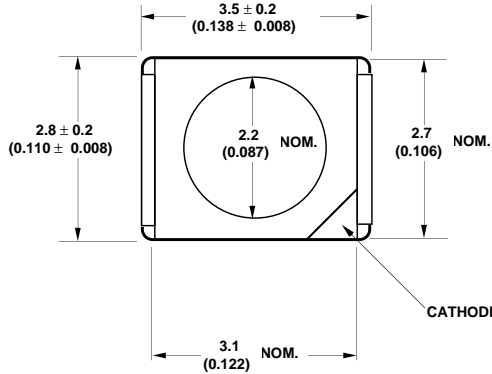

NOTES:
 1. ALL DIMENSIONS ARE IN MILLIMETERS (INCHES).
 2. THE LEADS ARE COPPER ALLOY, 85% Sn/15% Pb PLATING.

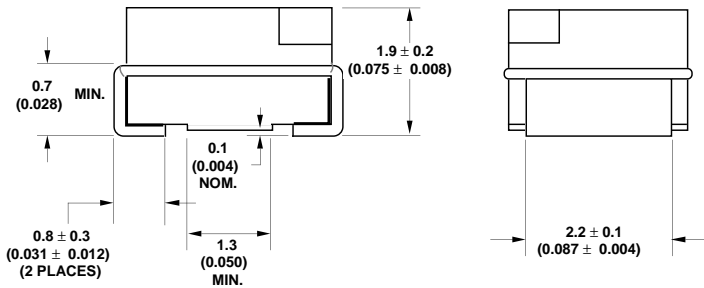

Tape and Reel Specifications

Hewlett Packard surface mount LEDs are packaged tape and reel in accordance with EIA-481A, *Taping of Surface Mount*

Components for Automatic Placement. This packaging system is compatible with taped automatic pick and place systems. Each reel is sealed in a

vapor barrier bag for added protection. Bulk packaging in vapor barrier bags is available upon special request.

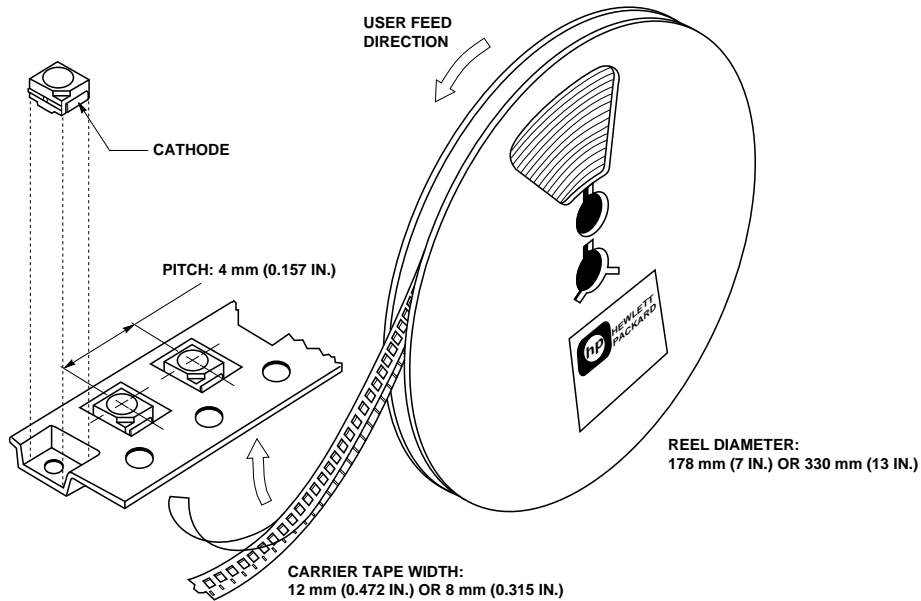

Absolute Maximum Ratings at $T_A = 25^\circ\text{C}$

DC Forward Current ^[1,4,5]	50 mA
Peak Forward Current ^[2]	200 mA
Average Forward Current	45 mA
(at $I_{PEAK} = 200\text{ mA}$, $f \geq 1\text{ KHz}$) ^[2]	
Transient Forward Current (10 μs Pulse) ^[3]	500 mA
Reverse Voltage ($I_R = 100\ \mu\text{A}$)	5 V
LED Junction Temperature	95°C
Operating Temperature Range	-40°C to +85°C
Storage Temperature Range	-40°C to +85°C
Reflow Soldering Temperatures	
Convective IR	235°C Peak, above 183°C for 90 seconds
Vapor Phase	215°C for 3 minutes

Notes:

- Derate linearly as shown in Figure 4.
- Refer to Figure 5 to establish pulsed operating conditions.
- The transient peak current is the maximum non-recurring peak current the device can withstand without damaging the LED die and wire bonds.
- Drive currents between 5 mA and 30 mA are recommended for best long term performance.
- Operation at currents below 5 mA is not recommended, please contact your Hewlett-Packard sales representative.

Optical Characteristics at $T_A = 25^\circ\text{C}$

Part Number	Luminous Intensity I_V (mcd) @ 10 mA		Peak Wavelength λ_{PEAK} (nm)	Color, Dominant Wavelength λ_d ^[1] (nm)	Viewing Angle $2\ \theta_{1/2}$ Degrees ^[2]	Luminous Efficacy η_v (lm/w)
	Min.	Typ.	Typ.	Typ.	Typ.	
HSMA-TX25	10	25	592	590	120	480
HSMD-TX25	10	25	607	603	120	370
HSMJ-TX25	10	25	621	615	120	263

Notes:

- The dominant wavelength, λ_d , is derived from the CIE Chromaticity Diagram and represents the color of the device.
- $\theta_{1/2}$ is the off-axis angle where the luminous intensity is 1/2 the peak intensity.

Electrical Characteristics at $T_A = 25^\circ\text{C}$

Part Number	Forward Voltage V_F (Volts) @ $I_F = 10\text{ mA}$		Reverse Breakdown V_R (Volts) @ $I_R = 100\ \mu\text{A}$		Capacitance C (pF) $V_F = 0$, $f = 1\text{ MHz}$	Thermal Resistance $R\theta_{J-PIN}$ ($^\circ\text{C/W}$)	Speed of Response τ_s (ns) Time Constant e^{-t/τ_s}
	Typ.	Max.	Min.	Typ.	Typ.		Typ.
HSMA-TX25	1.9	2.4	5	25	40	180	13
HSMD-TX25	1.9	2.4	5	25	40	180	13
HSMJ-TX25	1.9	2.4	5	25	40	180	13

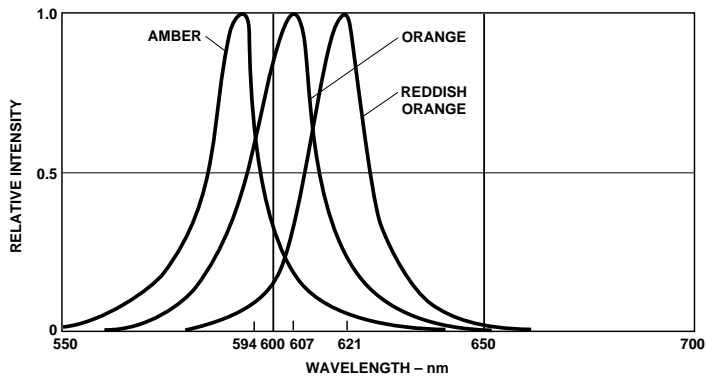

Figure 1. Relative Intensity vs. Wavelength.

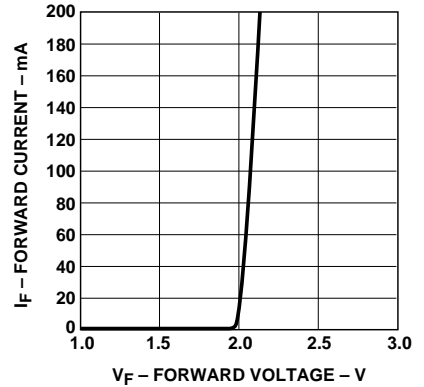

Figure 2. Forward Current vs. Forward Voltage.

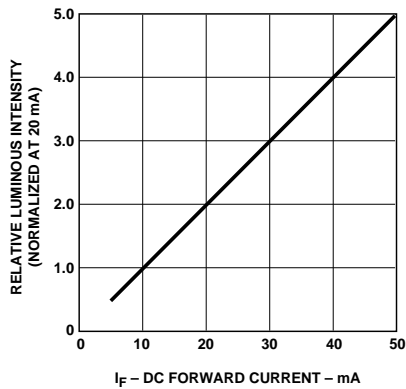

Figure 3. Relative Luminous Intensity vs. Forward Current.

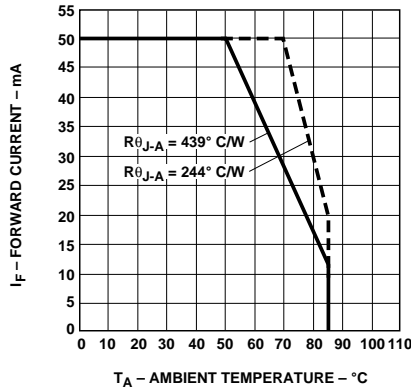

Figure 4. Maximum Forward Current vs. Ambient Temperature. Derating Based on $T_J \text{ Max} = 95^\circ\text{C}$.

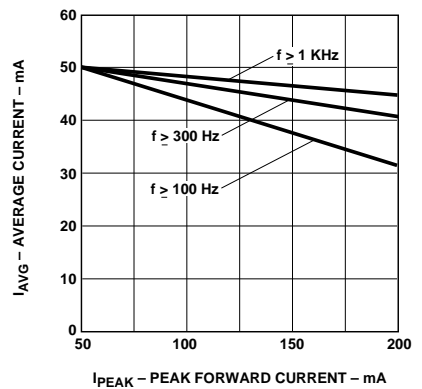

Figure 5. Maximum Average Current vs. Peak Forward Current.

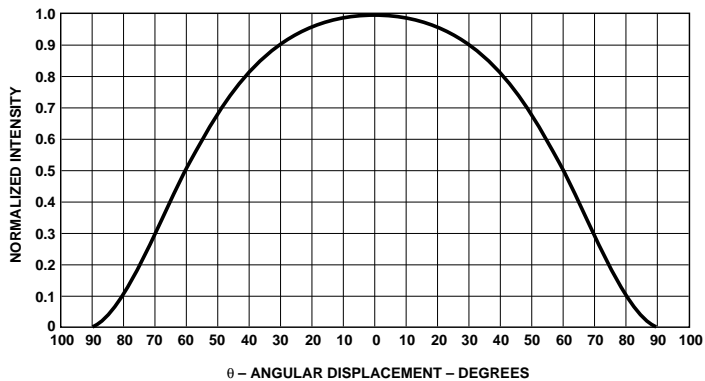
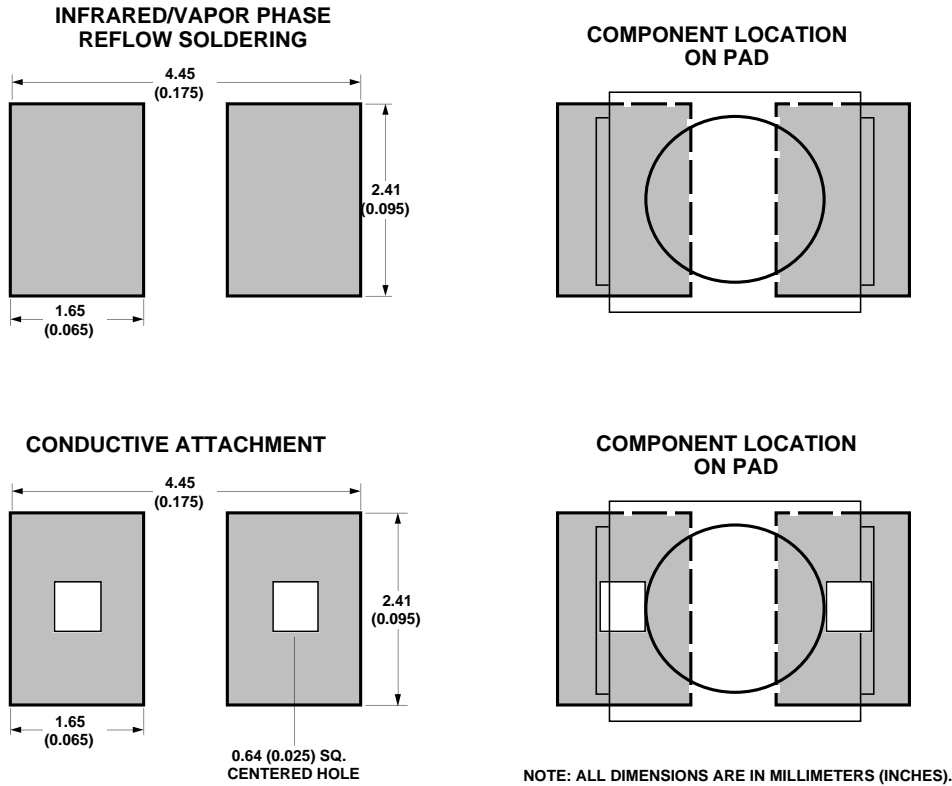

Figure 6. Relative Intensity vs. Angular Displacement.

Recommended Printed Circuit Board Attachment Pad Geometries



Convective IR Reflow Soldering

For information on convective IR reflow soldering, refer to the Supplement to Application Note 1060, *Surface Mounting SMT LED Components*.