

HSDL-4271

High-Performance T-1 $\frac{3}{4}$ (5mm) AlGaAs Infrared (940nm) Lamp



Datasheet

Description

The HSDL-4271 Infrared emitter was designed for applications that require high power and low forward voltage. It utilizes Aluminum Gallium Arsenide (AlGaAs) LED technology and is optimized for efficiency at emission wavelengths of 940 nm. The material used produces high radiant efficiency over a wide range of currents. The emitter is packaged in clear T-1 $\frac{3}{4}$ (5mm) package.

Features

- High Power AlGaAs LED Technology
- 940 nm Wavelength
- T-1 $\frac{3}{4}$ Package
- Low Cost
- Low Forward Voltage: 1.2V at 20mA

Applications

- Industrial Infrared Equipments and Applications (Smoke Detectors etc)
- Consumer Electronics (Infrared Remote Controller etc)
- Infrared spotlight for cameras
- Discrete Interrupters
- Infrared source for optical counters and card readers

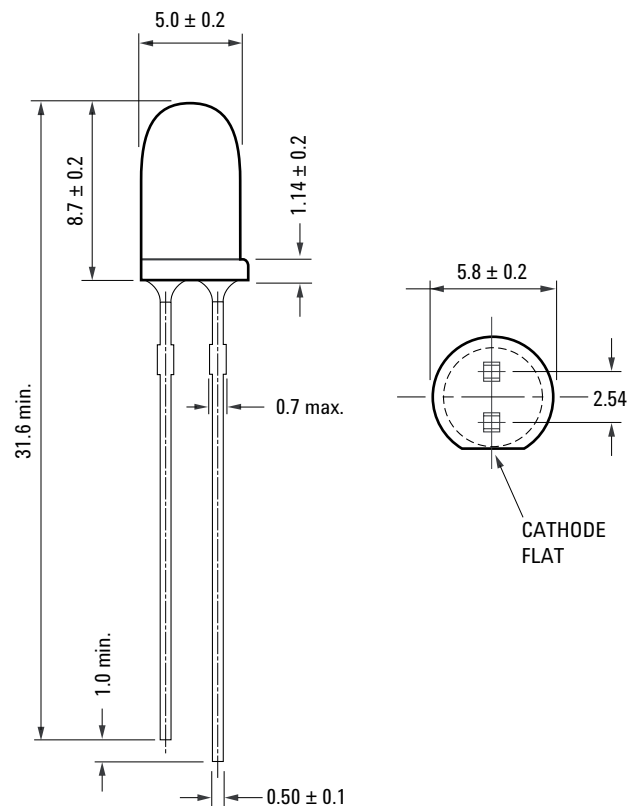

Part Number	Lead Form	Shipping Option
HSDL-4271	Straight	Bulk

Absolute Maximum Ratings at 25°C

Parameter	Symbol	Minimum	Maximum	Unit	Reference
Peak Forward Current	I_{FPK}	-	350	mA	Duty cycle = 20% period = 200us
Forward Current	I_{FDC}	-	100	mA	
Power Dissipation	P_{DISS}	-	200	mW	
Reverse Voltage	V_R	5	-	V	$I_R=100\mu A$
Storage Temperature	T_S	-40	100	°C	
LED Junction Temperature	T_J		110	°C	
Lead Soldering Temperature			260 for 5 sec	°C	

Notes:

1. Derate as shown in Figure 6.

Recommended Operating Conditions

Parameter	Symbol	Min	Max	Unit	Reference
Operating Temperature	T_O	-40	85	°C	

Electrical Characteristics at 25°C

Parameter	Symbol	Min.	Typ.	Max.	Unit	Condition	Reference
Forward Voltage	V_F	-	1.2 1.4	1.5 1.7	V	$I_{FDC}=20mA$ $I_{FDC}=100mA$	Figure 2 Figure 3
Forward Voltage Temperature Coefficient	$\Delta V/\Delta T$	-	-1.0	-	mV/°C	$I_{FDC}=100mA$	Figure 4
Series Resistance	R_S	-	2	-	Ohms	$I_{FDC}=100mA$	
Diode Capacitance	C_0	-	25	-	pF	$V_R=0V$, $f=1MHz$	
Thermal Resistance, Junction to Ambient	$R\theta_{ja}$	-	310	-	°C/W		

Optical Characteristics at 25°C

Parameter	Symbol	Min.	Typ.	Max.	Unit	Condition	Reference
Radiant On-Axis Intensity	I_E	25	50	-	mW/Sr	$I_{LED}=100mA$	Figure 4
Radiant On-Axis Intensity Temperature Coefficient	$\Delta I_E/\Delta T$	-	-0.3 -0.5	-	%/°C	$I_{LED}=100mA$	
Viewing Angle	$2\theta_{1/2}$	-	30	-	°		Figure 7
Peak Wavelength	λ_{pk}	-	940	-	nm		Figure 1
Spectral Width	$\Delta\lambda$	-	50	-	nm	$I_{LED}=20mA$	Figure 1
Optical Rise and Fall Time	t_r/t_f	-	1.3	-	us	$I_{LED}=100mA$	

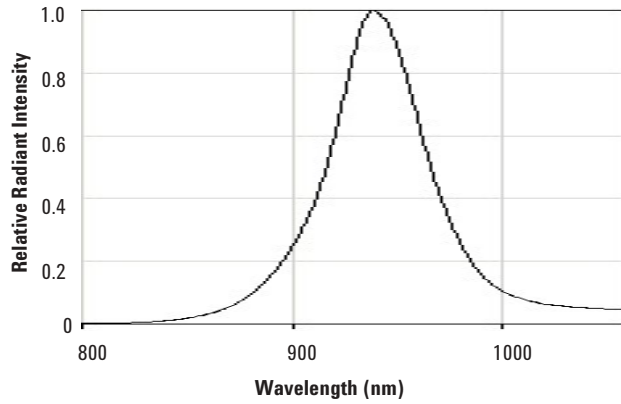

Figure 1. Relative Radiant Intensity vs. Wavelength

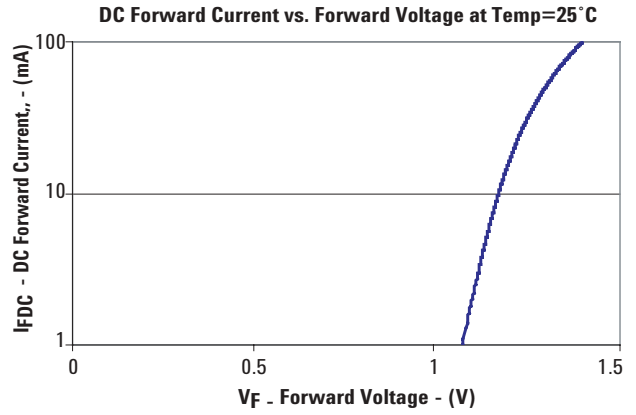

Figure 2. DC Forward Current vs. Forward Voltage

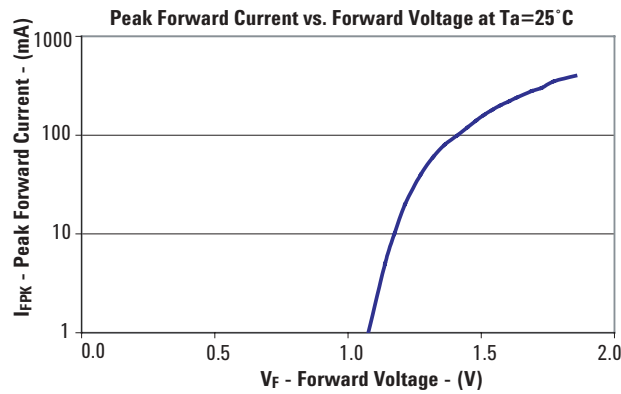

Figure 3. Peak Forward Current vs. Forward Voltage

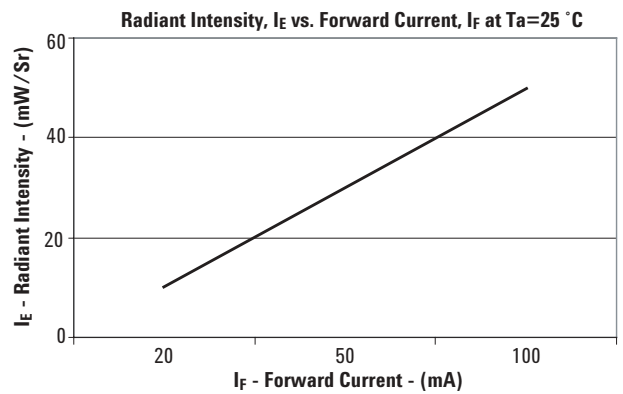

Figure 4. Radiant Intensity vs. DC Forward Current

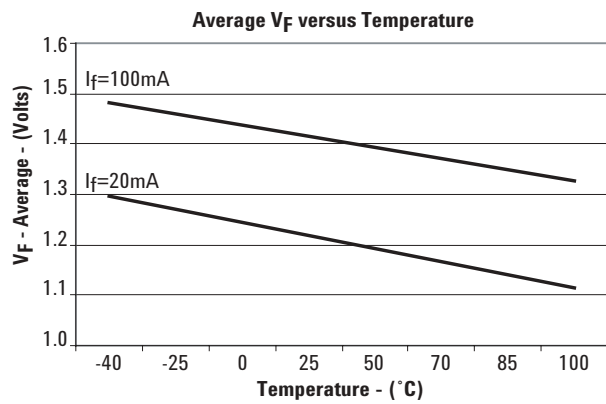

Figure 5. Forward Voltage vs. Ambient Temperature

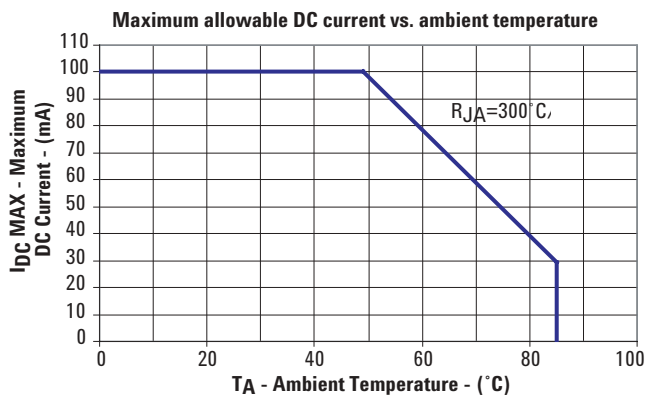

Figure 6: DC Forward Current vs. Ambient Temperature Derated Based on $T_{JMAX}=110^{\circ}C$

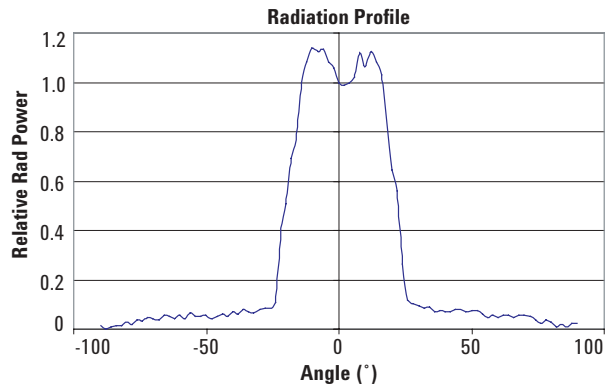

Figure 7. Radiant Intensity vs. Angular Displacement

For company and product information, please go to our web site: WWW.liteon.com or <http://optodatabook.liteon.com/databook/databook.aspx>

Data subject to change. Copyright © 2007 Lite-On Technology Corporation. All rights reserved.

