

# 27CP Series

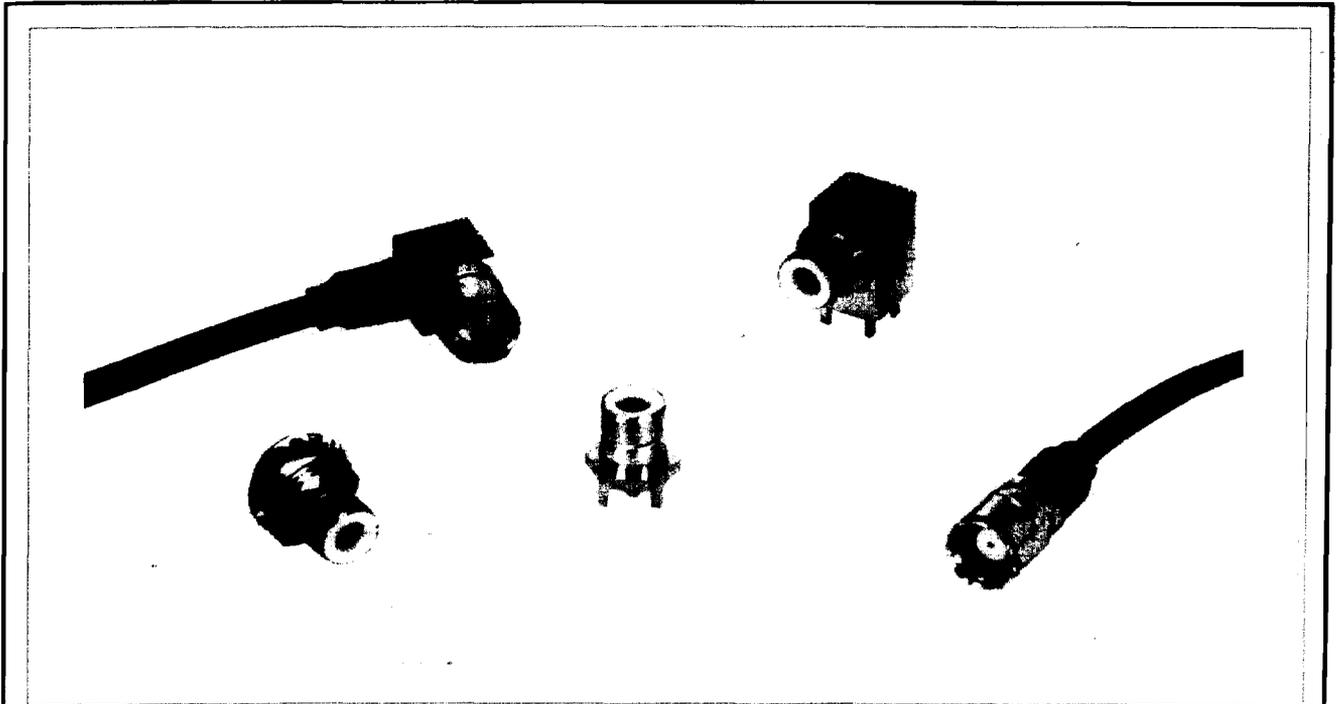

## Coaxial Connectors



### ■ FEATURES

- 27CP series are connectors for 75 ohm group of 27DP series (50 ohm group).
- Typical small size 75 ohm connectors usefull for interface within equipment.
- Provides easy push-pull coupling mechanism.
- 27DP series is not intermateable with.
- Usefull for interface of test instrmt, broadcasting equipment, CATV and HDTV, etc.

### ■ SPECIFICATION

Impedance.....75Ω  
Dielectric withstanding ...AC1500V(r.m.s.)  
voltage 1 minute  
Insulation resistance .....1000MΩ min.  
at 500V DC  
Contact resistance .....6mΩ max.  
at 1A DC  
VSWR.....1.2max. 2GHz

### ■ MATERIAL/FINISH

Shell(Body) .....Brass/Nickel plate  
Contact(male) .....Brass/Gold plate  
Contact(female) ...Beryllium copper/Gold plate  
Insulators .....Teflon

### ■ Mating Dimension

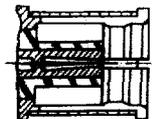

Plug Mating Face

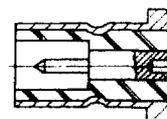
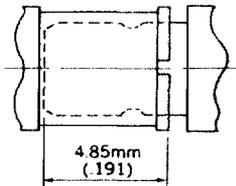

Jack Mating Face

# 27CP Series



## Plugs

Unit:mm(inch)

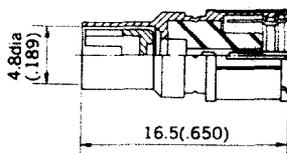

Name	Part no.	Applicable Cable	Hand crimp tool P/N
27CP-P-1.5	28506	1.5C-2V	CR-H-1100
27CP-P-2.5	28502	2.5C-2V	CR-H-1100

## Angle plugs

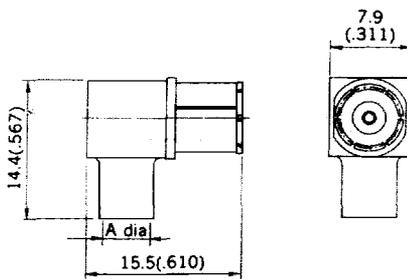

Name	Part no.	Applicable Cable	Dimensions	Hand crimp tool P/N
			A	
27CP-LP-1.5	28508	1.5C-2V	4.8 (.189)	CR-H-1100
27CP-LP-2.5W	28511	2.5C-2W	5.2 (.205)	CR-H-15285
27CP-LP-2.5	28504	2.5C-2V	4.8 (.189)	CR-H-1100

## Bulkhead jack

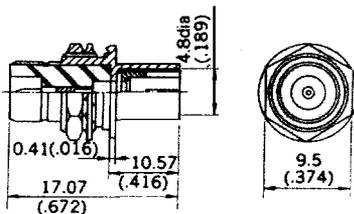

Name	Part no.	Applicable Cable	Hand crimp tool P/N	Mounting hole
27CP-BJ-1.5W	28544	1.5C-2W	CR-H-1100	Y

max. panel thickness : 2.4(.094)

# 27CP Series



## ■ Receptacles

Unit:mm(inch)

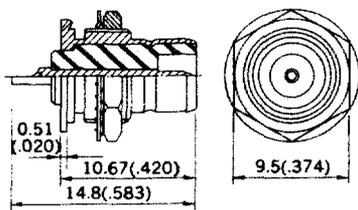

max. panel thickness : 2.4(094)

Name	Part no.	Mounting hole
27CP-BR	28501	Y

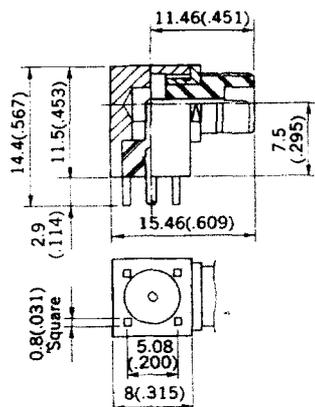

Name	Part no.	Mounting hole
27CP-LR-PC	28545	Z

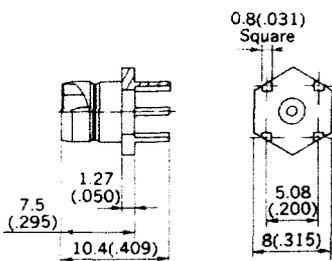

Name	Part no.	Mounting hole
27CP-R-PC	28520	Z

## ■ Mounting hole

