



# RF Power LDMOS Transistors

## N-Channel Enhancement-Mode Lateral MOSFETs

These 56 watt asymmetrical Doherty RF power LDMOS transistors are designed for cellular base station applications covering the frequency range of 920 to 960 MHz.

- Typical Doherty Single-Carrier W-CDMA Performance:  $V_{DD} = 28$  Volts,  $I_{DQA} = 680$  mA,  $V_{GSB} = 0.4$  Vdc,  $P_{out} = 56$  Watts Avg., Input Signal PAR = 9.9 dB @ 0.01% Probability on CCDF.

Frequency	$G_{ps}$ (dB)	$\eta_D$ (%)	Output PAR (dB)	ACPR (dBc)
920 MHz	17.9	47.4	8.2	-28.5
940 MHz	18.0	48.5	8.1	-31.2
960 MHz	18.2	47.3	7.9	-35.0

### Features

- Advanced High Performance In-Package Doherty
- Greater Negative Gate-Source Voltage Range for Improved Class C Operation
- Designed for Digital Predistortion Error Correction Systems
- In Tape and Reel. R6 Suffix = 150 Units, 56 mm Tape Width, 13-inch Reel.

**AFT09H310-03SR6**  
**AFT09H310-04GSR6**

**920-960 MHz, 56 W AVG., 28 V**  
**AIRFAST RF POWER LDMOS**  
**TRANSISTORS**

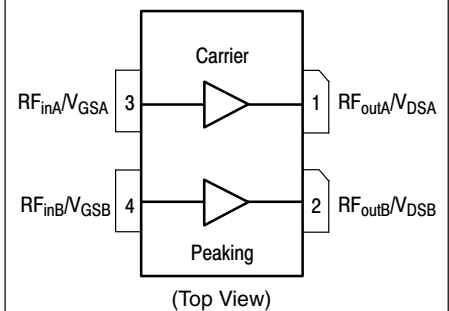
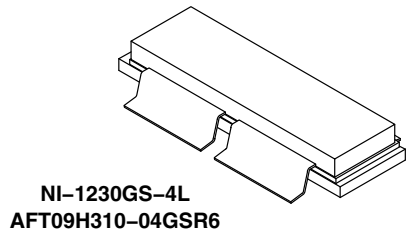
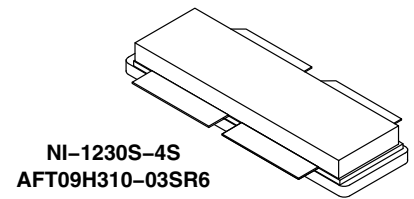

**Figure 1. Pin Connections**

**Table 1. Maximum Ratings**

Rating	Symbol	Value	Unit
Drain–Source Voltage	$V_{DSS}$	–0.5, +70	Vdc
Gate–Source Voltage	$V_{GS}$	–6.0, +10	Vdc
Operating Voltage	$V_{DD}$	32, +0	Vdc
Storage Temperature Range	$T_{stg}$	–65 to +150	°C
Case Operating Temperature Range	$T_C$	–40 to +150	°C
Operating Junction Temperature Range (1,2)	$T_J$	–40 to +225	°C
CW Operation @ $T_C = 25^\circ\text{C}$ Derate above $25^\circ\text{C}$	CW	256 0.9	W W/°C

**Table 2. Thermal Characteristics**

Characteristic	Symbol	Value (2,3)	Unit
Thermal Resistance, Junction to Case Case Temperature $75^\circ\text{C}$ , 56 W W–CDMA, 28 Vdc, $I_{DQA} = 680\text{ mA}$ , $V_{GSB} = 0.4\text{ Vdc}$ , 940 MHz	$R_{\theta JC}$	0.41	°C/W

**Table 3. ESD Protection Characteristics**

Test Methodology	Class
Human Body Model (per JESD22–A114)	2
Machine Model (per EIA/JESD22–A115)	B
Charge Device Model (per JESD22–C101)	IV

**Table 4. Electrical Characteristics** ( $T_A = 25^\circ\text{C}$  unless otherwise noted)

Characteristic	Symbol	Min	Typ	Max	Unit
----------------	--------	-----	-----	-----	------

**Off Characteristics (4)**

Zero Gate Voltage Drain Leakage Current ( $V_{DS} = 65\text{ Vdc}$ , $V_{GS} = 0\text{ Vdc}$ )	$I_{DSS}$	—	—	10	$\mu\text{Adc}$
Zero Gate Voltage Drain Leakage Current ( $V_{DS} = 28\text{ Vdc}$ , $V_{GS} = 0\text{ Vdc}$ )	$I_{DSS}$	—	—	1	$\mu\text{Adc}$
Gate–Source Leakage Current ( $V_{GS} = 5\text{ Vdc}$ , $V_{DS} = 0\text{ Vdc}$ )	$I_{GSS}$	—	—	1	$\mu\text{Adc}$

**On Characteristics – Side A (4) (Carrier)**

Gate Threshold Voltage ( $V_{DS} = 10\text{ Vdc}$ , $I_D = 242\ \mu\text{Adc}$ )	$V_{GS(th)}$	0.9	1.5	1.9	Vdc
Gate Quiescent Voltage ( $V_{DD} = 28\text{ Vdc}$ , $I_{DA} = 680\text{ mAdc}$ , Measured in Functional Test)	$V_{GSA(Q)}$	1.7	2.1	2.5	Vdc
Drain–Source On–Voltage ( $V_{GS} = 10\text{ Vdc}$ , $I_D = 1.0\text{ Adc}$ )	$V_{DS(on)}$	0.05	0.2	0.4	Vdc

**On Characteristics – Side B (4) (Peaking)**

Gate Threshold Voltage ( $V_{DS} = 10\text{ Vdc}$ , $I_D = 310\ \mu\text{Adc}$ )	$V_{GS(th)}$	0.9	1.5	1.9	Vdc
Drain–Source On–Voltage ( $V_{GS} = 10\text{ Vdc}$ , $I_D = 1.0\text{ Adc}$ )	$V_{DS(on)}$	0.05	0.2	0.4	Vdc

1. Continuous use at maximum temperature will affect MTTF.
2. MTTF calculator available at <http://www.freescale.com/rf>. Select Software & Tools/Development Tools/Calculators to access MTTF calculators by product.
3. Refer to AN1955, *Thermal Measurement Methodology of RF Power Amplifiers*. Go to <http://www.freescale.com/rf>. Select Documentation/Application Notes – AN1955.
4. Each side of device measured separately.

(continued)

**Table 4. Electrical Characteristics** ( $T_A = 25^\circ\text{C}$  unless otherwise noted) (continued)

Characteristic	Symbol	Min	Typ	Max	Unit
<b>Functional Tests</b> (1,2,3) (In Freescale Doherty Test Fixture, 50 ohm system) $V_{DD} = 28\text{ Vdc}$ , $I_{DQA} = 680\text{ mA}$ , $V_{GSB} = 0.4\text{ Vdc}$ , $P_{out} = 56\text{ W Avg.}$ , $f = 920\text{ MHz}$ , Single-Carrier W-CDMA, IQ Magnitude Clipping, Input Signal PAR = 9.9 dB @ 0.01% Probability on CCDF. ACPR measured in 3.84 MHz Channel Bandwidth @ $\pm 5\text{ MHz}$ Offset.					
Power Gain	$G_{ps}$	17.7	17.9	20.7	dB
Drain Efficiency	$\eta_D$	45.3	47.4	—	%
Output Peak-to-Average Ratio @ 0.01% Probability on CCDF	PAR	7.6	8.2	—	dB
Adjacent Channel Power Ratio	ACPR	—	-28.5	-27.3	dBc

**Load Mismatch** (In Freescale Test Fixture, 50 ohm system)  $I_{DQA} = 680\text{ mA}$ ,  $f = 940\text{ MHz}$ 

VSWR 10:1 at 32 Vdc, 280 W CW <sup>(4)</sup> Output Power (3 dB Input Overdrive from 180 W CW Rated Power)	No Device Degradation
---	-----------------------

**Typical Performances** (2) (In Freescale Doherty Test Fixture, 50 ohm system)  $V_{DD} = 28\text{ Vdc}$ ,  $I_{DQA} = 680\text{ mA}$ ,  $V_{GSB} = 0.4\text{ Vdc}$ , 920–960 MHz Bandwidth

$P_{out}$ @ 1 dB Compression Point, CW	P1dB	—	180	—	W
$P_{out}$ @ 3 dB Compression Point (5)	P3dB	—	390	—	W
AM/PM (Maximum value measured at the P3dB compression point across the 920 to 960 MHz frequency range)	$\Phi$	—	31.7	—	°
VBW Resonance Point (IMD Third Order Intermodulation Inflection Point)	$VBW_{res}$	—	45	—	MHz
Gain Flatness in 40 MHz Bandwidth @ $P_{out} = 56\text{ W Avg.}$	$G_F$	—	0.3	—	dB
Gain Variation over Temperature ( $-30^\circ\text{C}$ to $+85^\circ\text{C}$ )	$\Delta G$	—	0.015	—	dB/°C
Output Power Variation over Temperature ( $-30^\circ\text{C}$ to $+85^\circ\text{C}$ )	$\Delta P1dB$	—	0.035	—	dB/°C

- Part internally matched both on input and output.
- Measurements made with device in an asymmetrical Doherty configuration.
- Measurements made with device in straight lead configuration before any lead forming operation is applied. Lead forming is used for gull wing (GS) parts.
- Exceeds recommended operating conditions. See CW operation data in Maximum Ratings table.
- $P3dB = P_{avg} + 7.0\text{ dB}$  where  $P_{avg}$  is the average output power measured using an unclipped W-CDMA single-carrier input signal where output PAR is compressed to 7.0 dB @ 0.01% probability on CCDF.

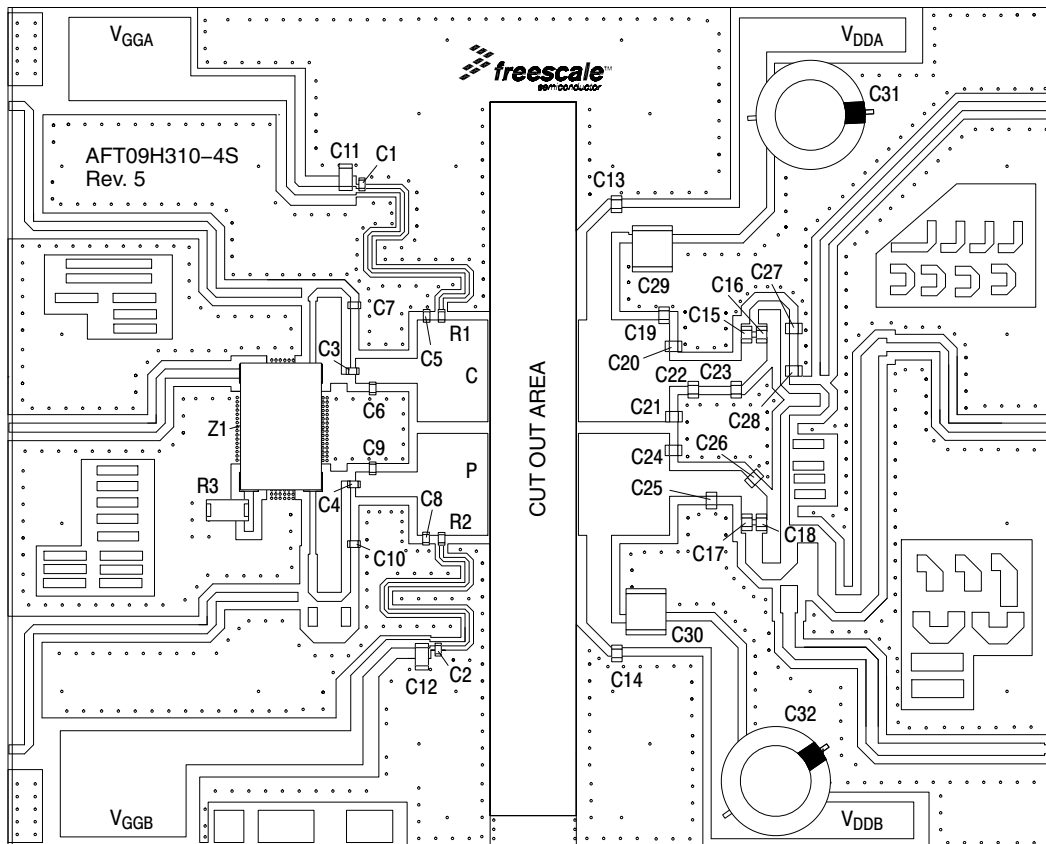

Figure 2. AFT09H310-03SR6 Test Circuit Component Layout — 920-960 MHz

Table 5. AFT09H310-03SR6 Test Circuit Component Designations and Values — 920-960 MHz

Part	Description	Part Number	Manufacturer
C1, C2, C3, C4	47 pF Chip Capacitors	GQM1875C2E470JB15	Murata
C5, C6	8.2 pF Chip Capacitors	GQM1875C2E8R2CB12D	Murata
C7, C10	1.2 pF Chip Capacitors	GQM1875C2E1R2BB15	Murata
C8, C9	6.8 pF Chip Capacitors	GQM1875C2E6R8BB15	Murata
C11, C12	10 $\mu$ F Chip Capacitors	GQM1875C2E6R8CB12D	Murata
C13, C14, C15, C16, C17, C18	68 pF Chip Capacitors	GQM2195C2E680GB15	Murata
C19, C20, C21	6.8 pF Chip Capacitors	GQM2195C2E6R8BB15	Murata
C22	3.3 pF Chip Capacitor	GQM2195C2E3R3BB15	Murata
C23, C24	3.9 pF Chip Capacitors	GQM2195C2E3R9BB15	Murata
C25, C26	4.7 pF Chip Capacitors	GQM2195C2E4R7BB15	Murata
C27, C28	1.8 pF Chip Capacitors	GQM2195C2E1R8BB15	Murata
C29, C30	10 $\mu$ F Chip Capacitors	C5750X7S2A106M230K	TDK
C31, C32	470 $\mu$ F, 63 V Chip Capacitors	MCGPR100V477M16X32-RH	Multicomp
R1, R2	5.1 $\Omega$ , 1/10 W Chip Resistors	CRCW06035R10FKEA	Vishay
R3	50 $\Omega$ , 10 W Termination	06012A25X50-2	Anaren
Z1	800-1000 MHz, 5 dB, Directional Coupler	XC0900A-05S	Anaren
PCB	0.020", $\epsilon_r = 3.5$	RO4350	Rogers

### TYPICAL CHARACTERISTICS

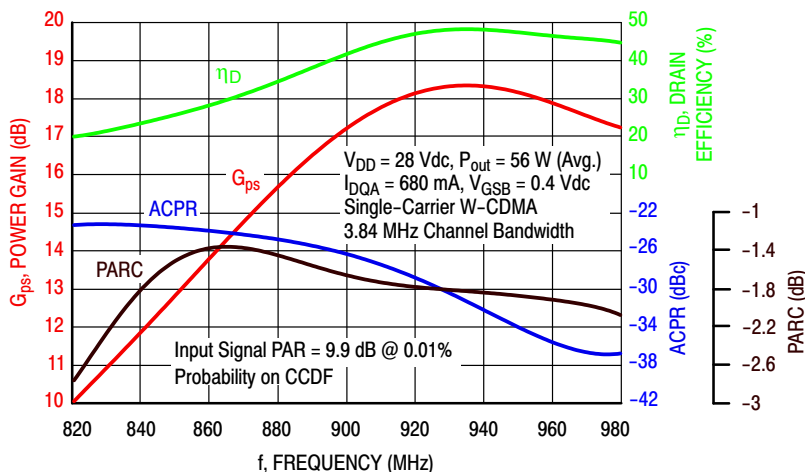

Figure 3. Single-Carrier Output Peak-to-Average Ratio Compression (PARC) Broadband Performance @  $P_{out} = 56$  Watts Avg.

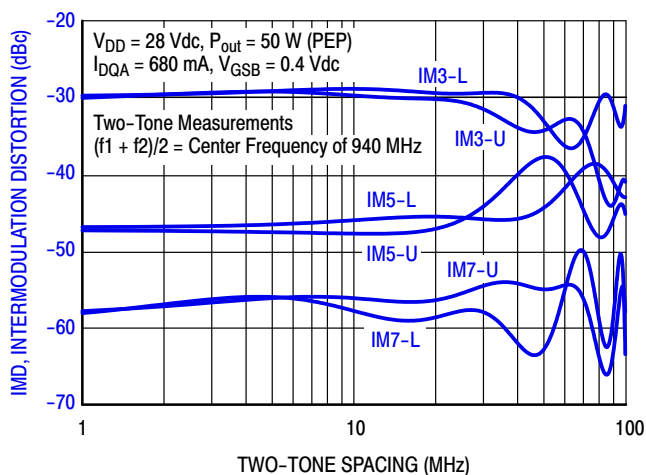

Figure 4. Intermodulation Distortion Products versus Two-Tone Spacing

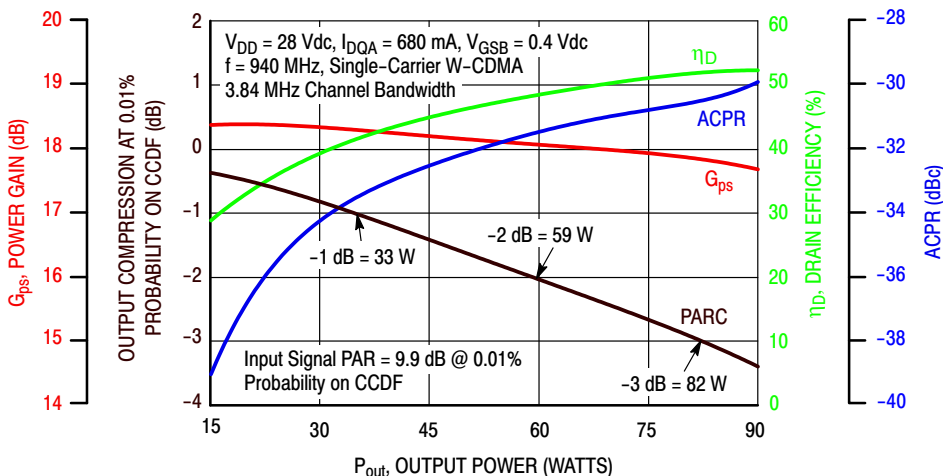
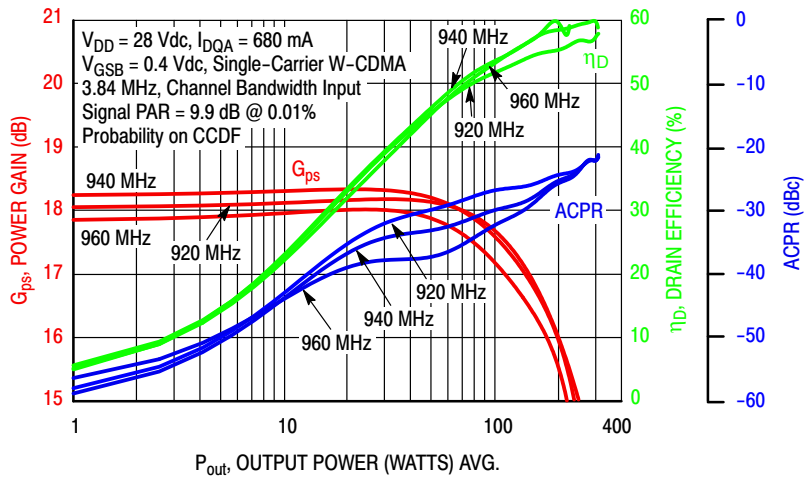
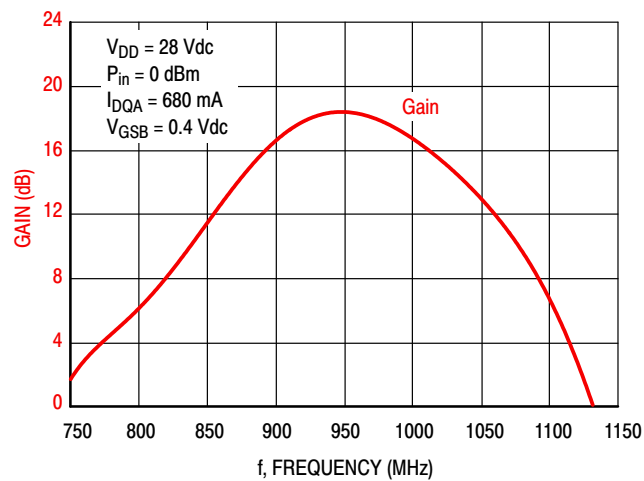

Figure 5. Output Peak-to-Average Ratio Compression (PARC) versus Output Power

## TYPICAL CHARACTERISTICS



**Figure 6. Single-Carrier W-CDMA Power Gain, Drain Efficiency and ACPR versus Output Power**



**Figure 7. Broadband Frequency Response**

$V_{DD} = 28 \text{ Vdc}$ ,  $I_{DQA} = 694 \text{ mA}$ , Pulsed CW, 10  $\mu\text{sec}(\text{on})$ , 10% Duty Cycle

f (MHz)	$Z_{\text{source}} (\Omega)$	$Z_{\text{in}} (\Omega)$	Max Output Power					
			P1dB					
			$Z_{\text{load}}^{(1)} (\Omega)$	Gain (dB)	(dBm)	(W)	$\eta_D$ (%)	AM/PM (°)
920	1.16 - j2.31	1.24 + j2.27	3.28 - j1.37	20.3	52.8	190	54.5	-8.1
940	1.35 - j2.39	1.40 + j2.40	3.44 - j1.49	20.2	52.9	193	55.0	-7.5
960	1.63 - j2.70	1.64 + j2.55	3.64 - j1.33	20.1	53.0	200	55.7	-8.2

f (MHz)	$Z_{\text{source}} (\Omega)$	$Z_{\text{in}} (\Omega)$	Max Output Power					
			P3dB					
			$Z_{\text{load}}^{(2)} (\Omega)$	Gain (dB)	(dBm)	(W)	$\eta_D$ (%)	AM/PM (°)
920	1.16 - j2.31	1.26 + j2.47	4.06 - j1.21	17.9	53.9	244	56.5	-13
940	1.35 - j2.39	1.44 + j2.60	4.14 - j1.14	18.0	53.9	247	57.5	-12
960	1.63 - j2.70	1.72 + j2.76	4.29 - j0.91	17.8	54.0	252	58.0	-13

(1) Load impedance for optimum P1dB power.

(2) Load impedance for optimum P3dB power.

$Z_{\text{source}}$  = Measured impedance presented to the input of the device at the package reference plane.

$Z_{\text{in}}$  = Impedance as measured from gate contact to ground.

$Z_{\text{load}}$  = Measured impedance presented to the output of the device at the package reference plane.

**Figure 8. Carrier Side Load Pull Performance — Maximum Power Tuning**

$V_{DD} = 28 \text{ Vdc}$ ,  $I_{DQA} = 694 \text{ mA}$ , Pulsed CW, 10  $\mu\text{sec}(\text{on})$ , 10% Duty Cycle

f (MHz)	$Z_{\text{source}} (\Omega)$	$Z_{\text{in}} (\Omega)$	Max Drain Efficiency					
			P1dB					
			$Z_{\text{load}}^{(1)} (\Omega)$	Gain (dB)	(dBm)	(W)	$\eta_D$ (%)	AM/PM (°)
920	1.16 - j2.31	0.81 + j1.89	0.96 - j0.03	24.8	49.9	99	68.9	-21
940	1.35 - j2.39	0.94 + j1.98	0.95 - j0.14	24.9	49.9	98	69.9	-21
960	1.63 - j2.70	1.07 + j2.08	0.86 - j0.21	25.0	49.6	92	71.0	-24

f (MHz)	$Z_{\text{source}} (\Omega)$	$Z_{\text{in}} (\Omega)$	Max Drain Efficiency					
			P3dB					
			$Z_{\text{load}}^{(2)} (\Omega)$	Gain (dB)	(dBm)	(W)	$\eta_D$ (%)	AM/PM (°)
920	1.16 - j2.31	0.89 + j2.16	1.06 + j0.03	22.8	50.8	121	70.9	-29
940	1.35 - j2.39	1.06 + j2.28	1.10 - j0.07	22.8	50.9	124	72.0	-27
960	1.63 - j2.70	1.39 + j2.49	1.40 - j0.21	21.7	51.8	153	71.6	-23

(1) Load impedance for optimum P1dB efficiency.

(2) Load impedance for optimum P3dB efficiency.

$Z_{\text{source}}$  = Measured impedance presented to the input of the device at the package reference plane.

$Z_{\text{in}}$  = Impedance as measured from gate contact to ground.

$Z_{\text{load}}$  = Measured impedance presented to the output of the device at the package reference plane.

**Figure 9. Carrier Side Load Pull Performance — Maximum Drain Efficiency Tuning**

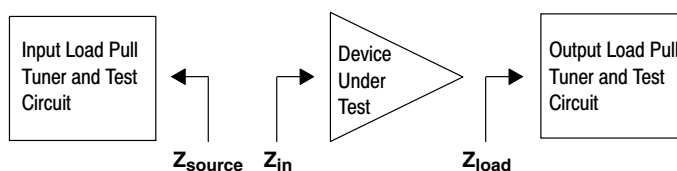

AFT09H310-03SR6 AFT09H310-04GSR6

$V_{DD} = 28 \text{ Vdc}$ ,  $V_{GSB} = 0.4 \text{ Vdc}$ , Pulsed CW, 10  $\mu\text{sec}(\text{on})$ , 10% Duty Cycle

f (MHz)	$Z_{\text{source}} (\Omega)$	$Z_{\text{in}} (\Omega)$	Max Output Power					
			P1dB					
			$Z_{\text{load}}^{(1)} (\Omega)$	Gain (dB)	(dBm)	(W)	$\eta_D$ (%)	AM/PM (°)
920	1.72 - j3.65	1.84 + j3.30	4.60 - j2.13	13.7	53.8	241	55.6	-8.3
940	2.37 - j3.46	2.28 + j3.50	5.46 - j2.55	13.3	53.9	245	53.1	-7.3
960	2.89 - j3.77	2.85 + j3.70	5.68 - j2.16	13.3	54.0	250	54.1	-7.9

f (MHz)	$Z_{\text{source}} (\Omega)$	$Z_{\text{in}} (\Omega)$	Max Output Power					
			P3dB					
			$Z_{\text{load}}^{(2)} (\Omega)$	Gain (dB)	(dBm)	(W)	$\eta_D$ (%)	AM/PM (°)
920	1.72 - j3.65	1.99 + j3.42	5.63 - j2.02	11.2	54.9	312	56.1	-11
940	2.37 - j3.46	2.43 + j3.61	6.13 - j1.80	11.1	55.0	313	55.8	-10
960	2.89 - j3.77	3.06 + j3.78	6.35 - j1.22	11.1	55.0	318	56.3	-10

(1) Load impedance for optimum P1dB power.

(2) Load impedance for optimum P3dB power.

$Z_{\text{source}}$  = Measured impedance presented to the input of the device at the package reference plane.

$Z_{\text{in}}$  = Impedance as measured from gate contact to ground.

$Z_{\text{load}}$  = Measured impedance presented to the output of the device at the package reference plane.

**Figure 10. Peaking Side Load Pull Performance — Maximum Power Tuning**

$V_{DD} = 28 \text{ Vdc}$ ,  $V_{GSB} = 0.4 \text{ Vdc}$ , Pulsed CW, 10  $\mu\text{sec}(\text{on})$ , 10% Duty Cycle

f (MHz)	$Z_{\text{source}} (\Omega)$	$Z_{\text{in}} (\Omega)$	Max Drain Efficiency					
			P1dB					
			$Z_{\text{load}}^{(1)} (\Omega)$	Gain (dB)	(dBm)	(W)	$\eta_D$ (%)	AM/PM (°)
920	1.72 - j3.65	1.63 + j3.16	1.40 - j0.57	14.9	51.3	135	70.4	-15
940	2.37 - j3.46	1.95 + j3.29	0.95 - j0.75	14.8	50.1	102	72.3	-17
960	2.89 - j3.77	2.52 + j3.52	1.33 - j0.87	14.8	51.1	130	72.7	-16

f (MHz)	$Z_{\text{source}} (\Omega)$	$Z_{\text{in}} (\Omega)$	Max Drain Efficiency					
			P3dB					
			$Z_{\text{load}}^{(2)} (\Omega)$	Gain (dB)	(dBm)	(W)	$\eta_D$ (%)	AM/PM (°)
920	1.72 - j3.65	1.74 + j3.32	1.57 - j0.45	12.9	52.2	167	71.4	-19
940	2.37 - j3.46	2.16 + j3.51	1.67 - j0.54	12.8	52.3	171	72.1	-18
960	2.89 - j3.77	2.71 + j3.69	1.55 - j0.69	12.8	52.2	164	73.2	-20

(1) Load impedance for optimum P1dB efficiency.

(2) Load impedance for optimum P3dB efficiency.

$Z_{\text{source}}$  = Measured impedance presented to the input of the device at the package reference plane.

$Z_{\text{in}}$  = Impedance as measured from gate contact to ground.

$Z_{\text{load}}$  = Measured impedance presented to the output of the device at the package reference plane.

**Figure 11. Peaking Side Load Pull Performance — Maximum Drain Efficiency Tuning**

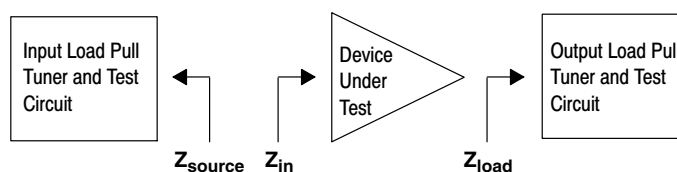



P1dB – TYPICAL CARRIER SIDE LOAD PULL CONTOURS — 940 MHz

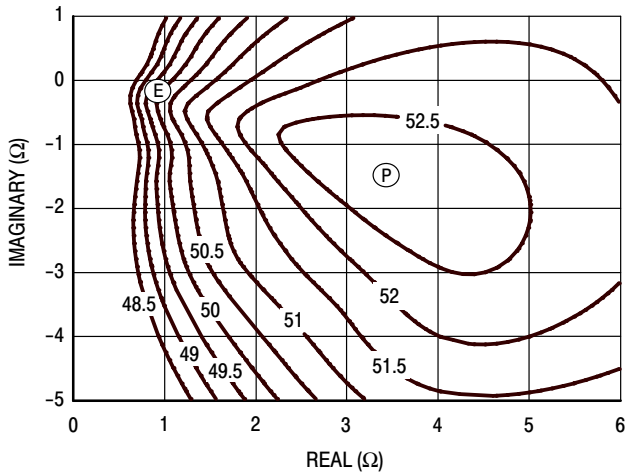

Figure 12. P1dB Load Pull Output Power Contours (dBm)

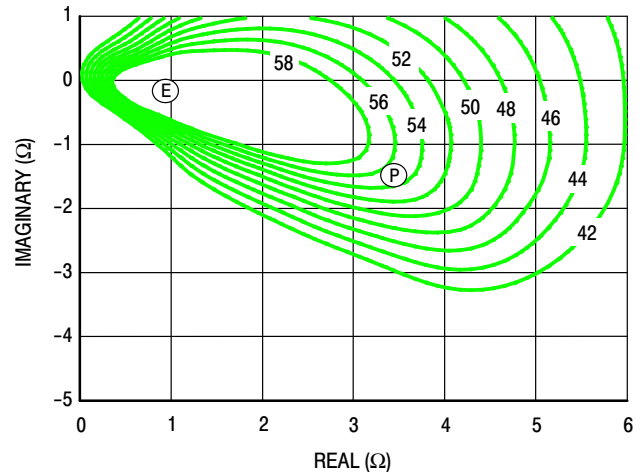

Figure 13. P1dB Load Pull Efficiency Contours (%)

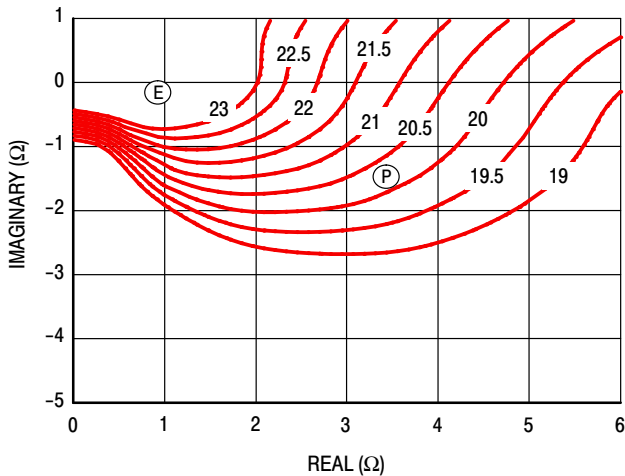

Figure 14. P1dB Load Pull Gain Contours (dB)

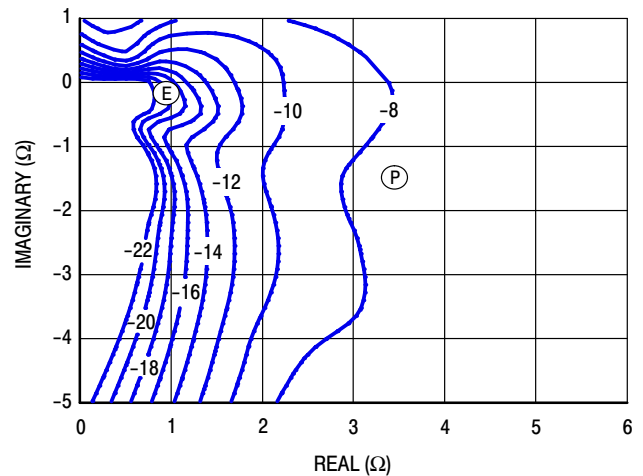
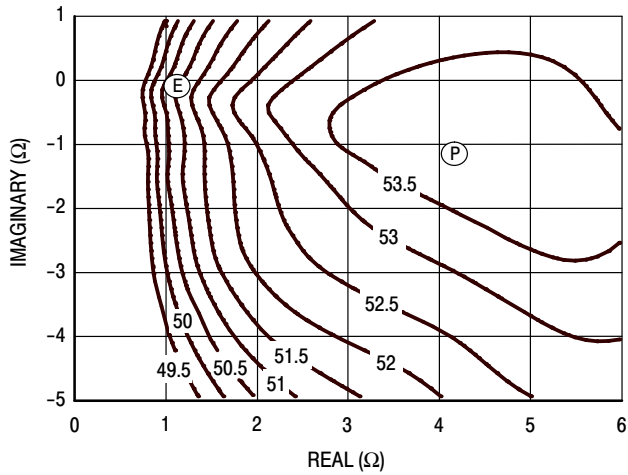

Figure 15. P1dB Load Pull AM/PM Contours (°)

**NOTE:** (P) = Maximum Output Power  
(E) = Maximum Drain Efficiency

- Gain
- Drain Efficiency
- Linearity
- Output Power

## P3dB – TYPICAL CARRIER SIDE LOAD PULL CONTOURS — 940 MHz



**Figure 16. P3dB Load Pull Output Power Contours (dBm)**

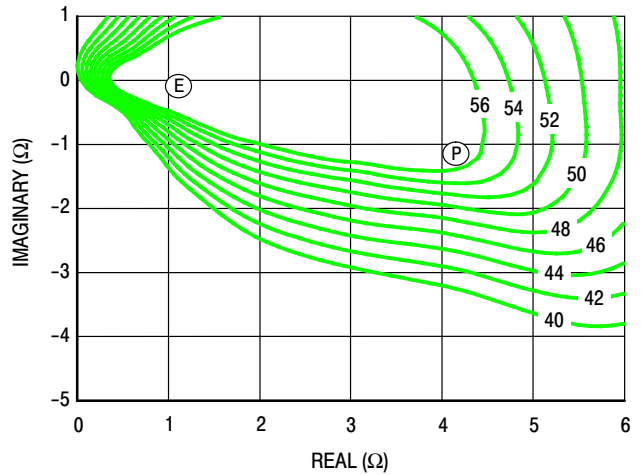

**Figure 17. P3dB Load Pull Efficiency Contours (%)**

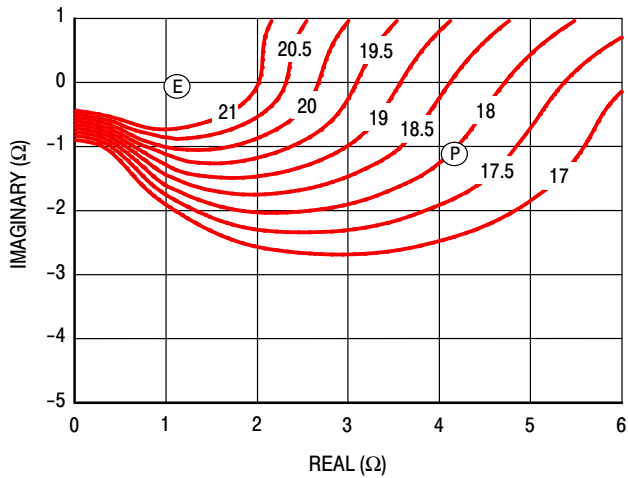

**Figure 18. P3dB Load Pull Gain Contours (dB)**

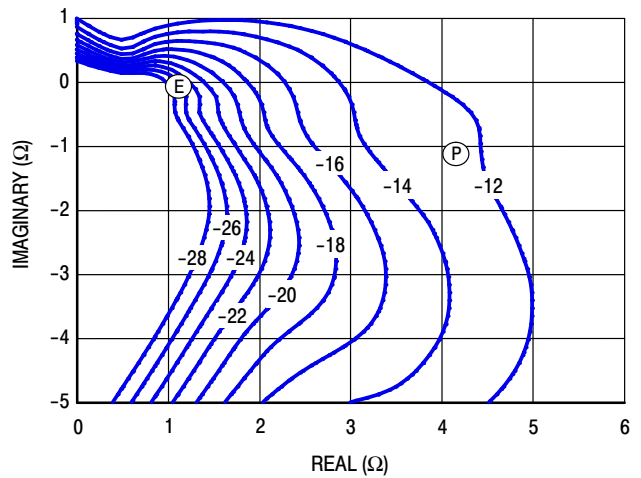
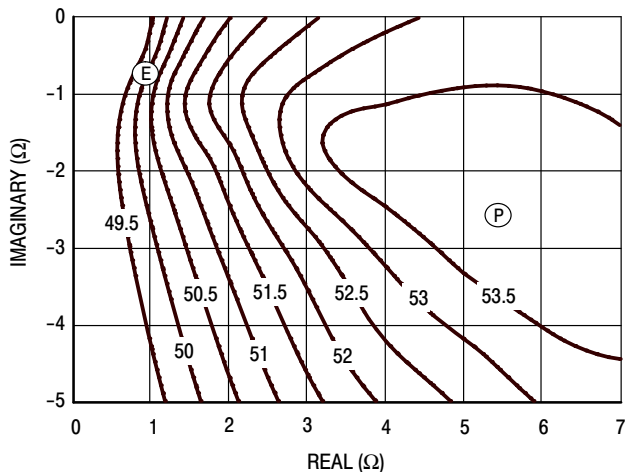

**Figure 19. P3dB Load Pull AM/PM Contours (°)**

**NOTE:** (P) = Maximum Output Power  
(E) = Maximum Drain Efficiency

- Gain
- Drain Efficiency
- Linearity
- Output Power

**P1dB – TYPICAL PEAKING SIDE LOAD PULL CONTOURS — 940 MHz**



**Figure 20. P1dB Load Pull Output Power Contours (dBm)**

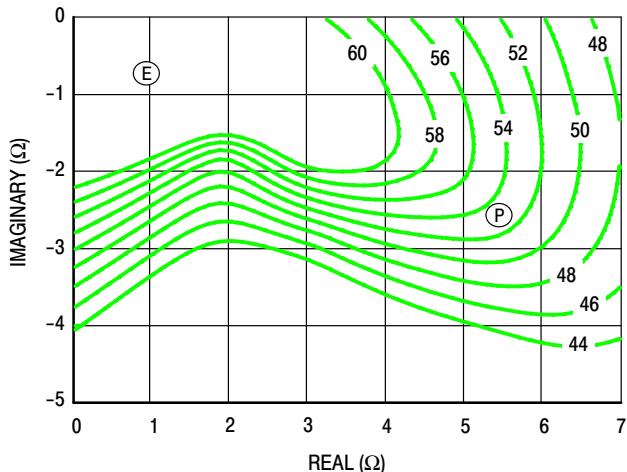

**Figure 21. P1dB Load Pull Efficiency Contours (%)**

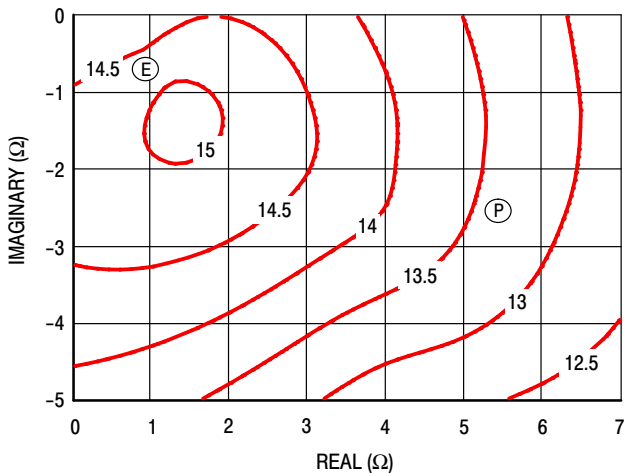

**Figure 22. P1dB Load Pull Gain Contours (dB)**

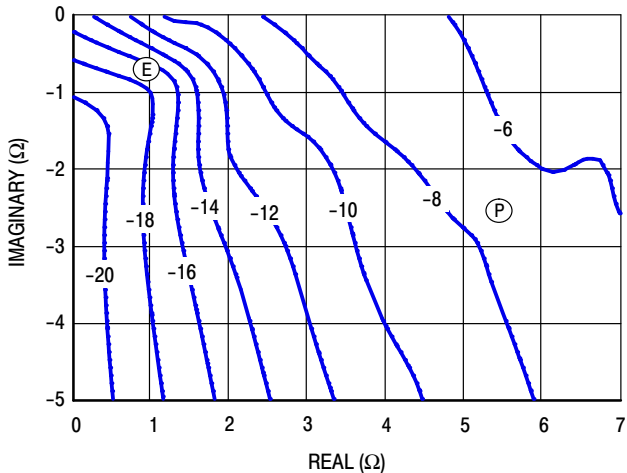
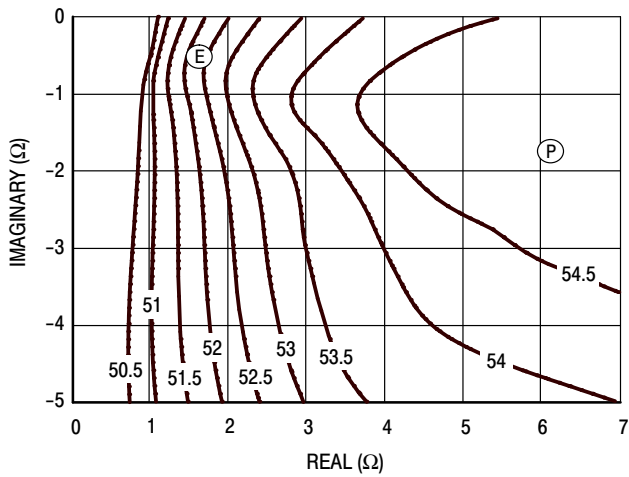

**Figure 23. P1dB Load Pull AM/PM Contours (°)**

**NOTE:** (P) = Maximum Output Power  
 (E) = Maximum Drain Efficiency

- Gain
- Drain Efficiency
- Linearity
- Output Power

**P3dB – TYPICAL PEAKING SIDE LOAD PULL CONTOURS — 940 MHz**



**Figure 24. P3dB Load Pull Output Power Contours (dBm)**

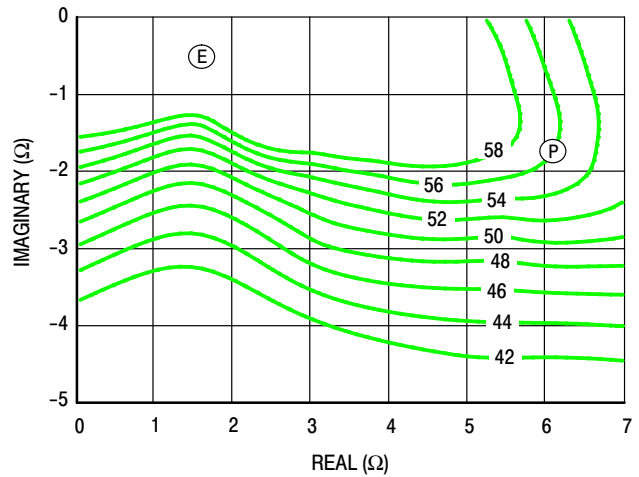

**Figure 25. P3dB Load Pull Efficiency Contours (%)**

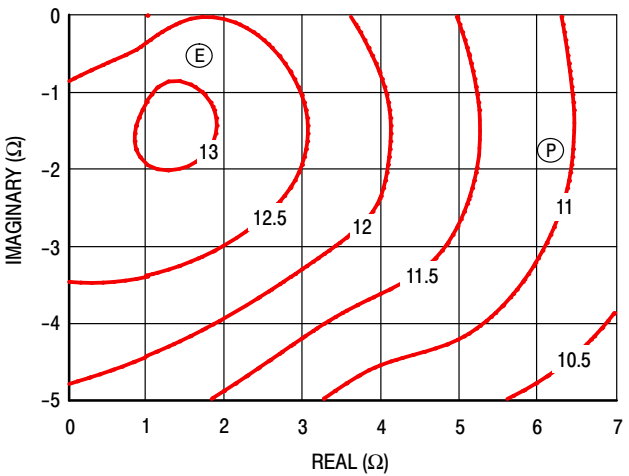

**Figure 26. P3dB Load Pull Gain Contours (dB)**

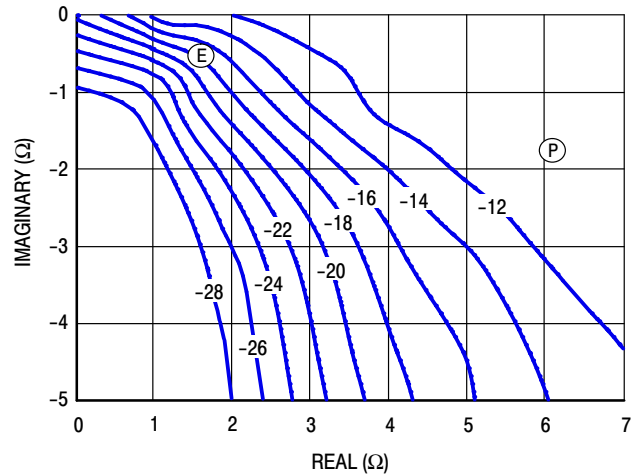

**Figure 27. P3dB Load Pull AM/PM Contours (°)**

**NOTE:** (P) = Maximum Output Power  
(E) = Maximum Drain Efficiency

- Gain
- Drain Efficiency
- Linearity
- Output Power



NOTES:

1. INTERPRET DIMENSIONS AND TOLERANCES PER ASME Y14.5M-1994.
2. CONTROLLING DIMENSION: INCH
3. DIMENSION H IS MEASURED .030 INCH (0.762 MM) AWAY FROM PACKAGE BODY

DIM	INCHES		MILLIMETERS		DIM	INCHES		MILLIMETERS	
	MIN	MAX	MIN	MAX		MIN	MAX	MIN	MAX
AA	1.265	1.275	32.13	32.39	R	.355	.365	9.02	9.27
BB	.395	.405	10.03	10.29	S	.365	.375	9.27	9.53
CC	.170	.190	4.32	4.83	Z	R.000	R.040	R0.00	R1.02
D	.455	.465	11.56	11.81					
E	.062	.066	1.57	1.68	aaa	.013		0.33	
F	.004	.007	0.10	0.18	bbb	.010		0.25	
H	.082	.090	2.08	2.29	ccc	.020		0.51	
K	.117	.137	2.97	3.48					
L	.540 BSC		13.72 BSC						
M	1.219	1.241	30.96	31.52					
N	1.218	1.242	30.94	31.55					
© FREESCALE SEMICONDUCTOR, INC. ALL RIGHTS RESERVED.			MECHANICAL OUTLINE			PRINT VERSION NOT TO SCALE			
TITLE:  NI-1230-4S					DOCUMENT NO: 98ARB18247C		REV: G		
					STANDARD: NON-JEDEC				
					01 MAR 2013				

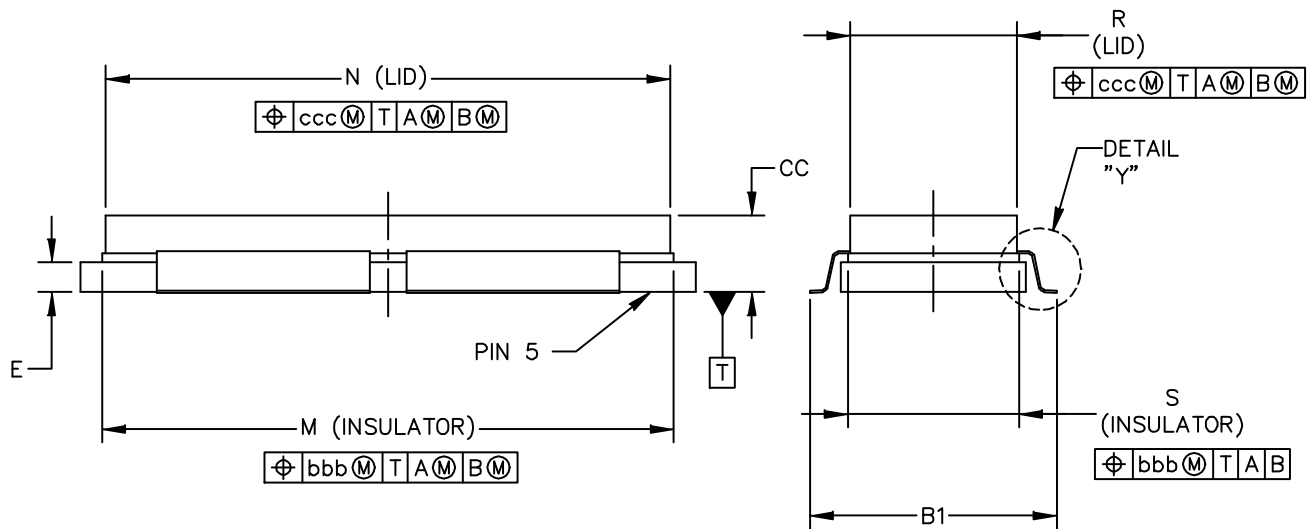
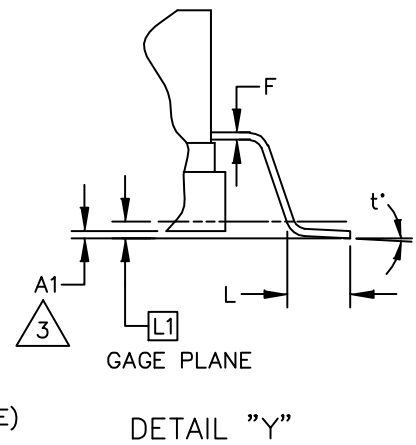
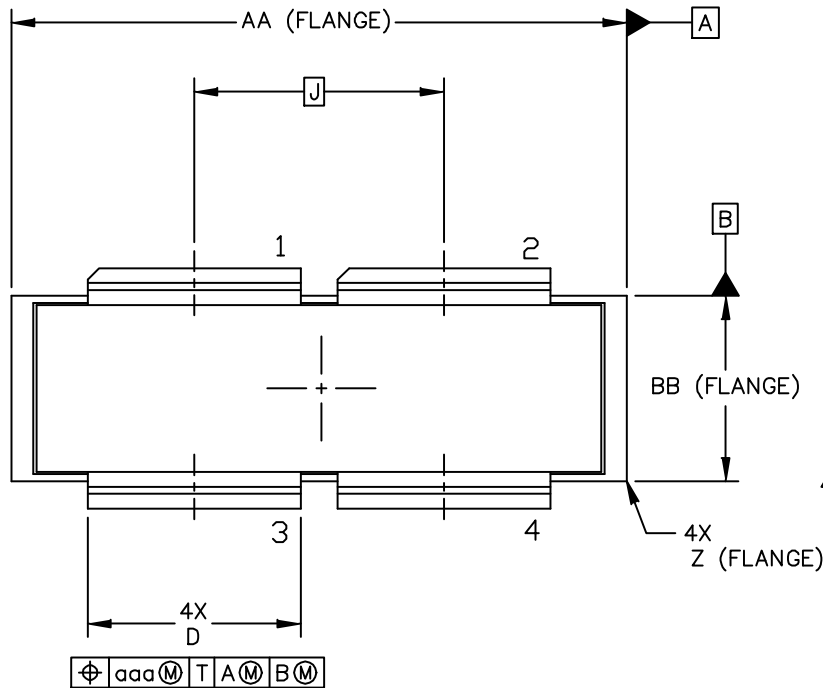

© FREESCALE SEMICONDUCTOR, INC. ALL RIGHTS RESERVED.	MECHANICAL OUTLINE	PRINT VERSION NOT TO SCALE
TITLE:  NI-1230-4S GULL	DOCUMENT NO: 98ASA00459D	REV: A
	STANDARD: NON-JEDEC	
	07 MAR 2013	

NOTES:

1. INTERPRET DIMENSIONS AND TOLERANCES PER ASME Y14.5M-1994.

2. CONTROLLING DIMENSION: INCH

3. DIMENSION A1 IS MEASURED WITH REFERENCE TO DATUM T. THE POSITIVE VALUE IMPLIES THAT THE PACKAGE BOTTOM IS HIGHER THAN THE LEAD BOTTOM.

DIM	INCHES		MILLIMETERS		DIM	INCHES		MILLIMETERS	
	MIN	MAX	MIN	MAX		MIN	MAX	MIN	MAX
AA	1.265	1.275	32.13	32.39	R	.355	.365	9.02	9.27
A1	-.001	.011	-0.03	0.28	S	.365	.375	9.27	9.53
BB	.395	.405	10.03	10.29	Z	R.000	R.040	R0.00	R1.02
B1	.564	.574	14.32	14.58	t'	0'	8'	0'	8'
CC	.170	.190	4.32	4.83					
D	.455	.465	11.56	11.81	aaa	.013		0.33	
E	.062	.066	1.57	1.68	bbb	.010		0.25	
F	.004	.007	0.10	0.18	ccc	.020		0.51	
J	.540 BSC		13.72 BSC						
L	.038	.046	0.97	1.17					
L1	.01 BSC		0.25 BSC						
M	1.219	1.241	30.96	31.52					
N	1.218	1.242	30.94	31.55					
© FREESCALE SEMICONDUCTOR, INC. ALL RIGHTS RESERVED.			MECHANICAL OUTLINE			PRINT VERSION NOT TO SCALE			
TITLE:  NI-1230-4S GULL					DOCUMENT NO: 98ASA00459D      REV: A				
					STANDARD: NON-JEDEC				
					07 MAR 2013				



## PRODUCT DOCUMENTATION, SOFTWARE AND TOOLS

Refer to the following documents, software and tools to aid your design process.

### Application Notes

- AN1955: Thermal Measurement Methodology of RF Power Amplifiers

### Engineering Bulletins

- EB212: Using Data Sheet Impedances for RF LDMOS Devices

### Software

- Electromigration MTTF Calculator
- RF High Power Model
- .s2p File

### Development Tools

- Printed Circuit Boards

For Software and Tools, do a Part Number search at <http://www.freescale.com>, and select the “Part Number” link. Go to the Software & Tools tab on the part’s Product Summary page to download the respective tool.

## REVISION HISTORY

The following table summarizes revisions to this document.

Revision	Date	Description
0	July 2013	• Initial Release of Data Sheet
1	Sept. 2013	• On Characteristics table, Side B (Peaking): corrected $V_{GS(th)}$ Typ value from 2.0 to 1.5 Vdc, p. 2

---

## ***How to Reach Us:***

**Home Page:**  
[freescale.com](http://freescale.com)

**Web Support:**  
[freescale.com/support](http://freescale.com/support)

Information in this document is provided solely to enable system and software implementers to use Freescale products. There are no express or implied copyright licenses granted hereunder to design or fabricate any integrated circuits based on the information in this document.

Freescale reserves the right to make changes without further notice to any products herein. Freescale makes no warranty, representation, or guarantee regarding the suitability of its products for any particular purpose, nor does Freescale assume any liability arising out of the application or use of any product or circuit, and specifically disclaims any and all liability, including without limitation consequential or incidental damages. "Typical" parameters that may be provided in Freescale data sheets and/or specifications can and do vary in different applications, and actual performance may vary over time. All operating parameters, including "typicals," must be validated for each customer application by customer's technical experts. Freescale does not convey any license under its patent rights nor the rights of others. Freescale sells products pursuant to standard terms and conditions of sale, which can be found at the following address: [freescale.com/SalesTermsandConditions](http://freescale.com/SalesTermsandConditions).

Freescale and the Freescale logo are trademarks of Freescale Semiconductor, Inc., Reg. U.S. Pat. & Tm. Off. Airfast is a trademark of Freescale Semiconductor, Inc. All other product or service names are the property of their respective owners.

© 2013 Freescale Semiconductor, Inc.

