



## GaAs MMIC LOW NOISE AMPLIFIER, 3.5 - 7.0 GHz

### Typical Applications

The HMC392LC4 is ideal for:

- Point-to-Point Radios
- VSAT
- LO Driver for HMC Mixers
- Military EW, ECM, C<sup>3</sup>I
- Space

### Features

- Gain: 16 dB
- Noise Figure: 2.5 dB
- Single Supply Voltage: +5V
- No External Matching Components Required
- 50 Ohm Matched Input/Output
- RoHS Compliant 4x4 mm SMT Package

### Functional Diagram

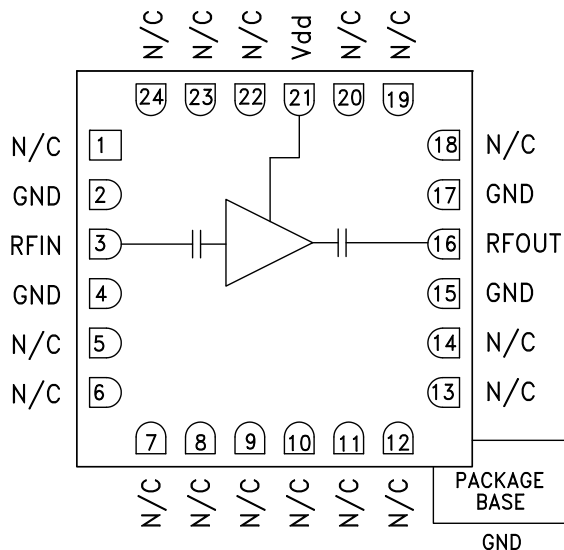

### General Description

The HMC392LC4 is a GaAs MMIC Low Noise Amplifier which operates between 3.5 and 7.0 GHz. Housed in a leadless 4x4 mm SMT package, this amplifier provides 16 dB of gain, 2.5 dB noise figure and 30 dBm IP3 from a +5V supply voltage. HMC392LC4 functions well as a low noise front end or as a driver amplifier. The RF I/Os are DC blocked and matched to 50 Ohms for ease of use. The HMC392LC4 allows the use of surface mount manufacturing techniques and is suitable for high reliability military, industrial and space applications.

### Electrical Specifications, $T_A = +25^\circ \text{C}$ , $V_{dd} = 5V$

Parameter	Min.	Typ.	Max.	Min.	Typ.	Max.	Units
Frequency Range	4.0 - 6.0			3.5 - 7.0			GHz
Gain	13.5	16		12.5	14.5		dB
Gain Variation Over Temperature		0.018	0.025		0.018	0.025	dB/°C
Input Return Loss		15			12		dB
Output Return Loss		18			12		dB
Output Power for 1 dB Compression (P1dB)	13	16		12	16		dBm
Saturated Output Power (P <sub>sat</sub> )		20			20		dBm
Output Third Order Intercept (IP3)	25	30		23	30		dBm
Noise Figure		2.5	3.1		2.9	3.5	dB
Supply Current (I <sub>dd</sub> )		55	75		55	75	mA

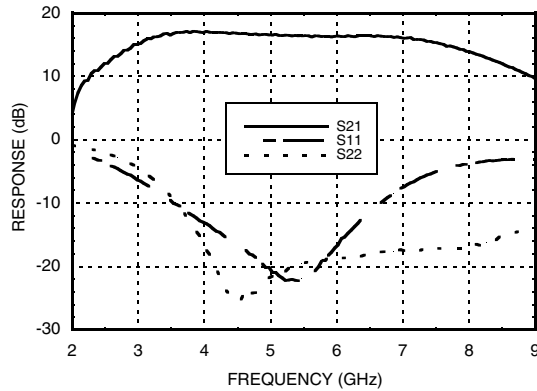
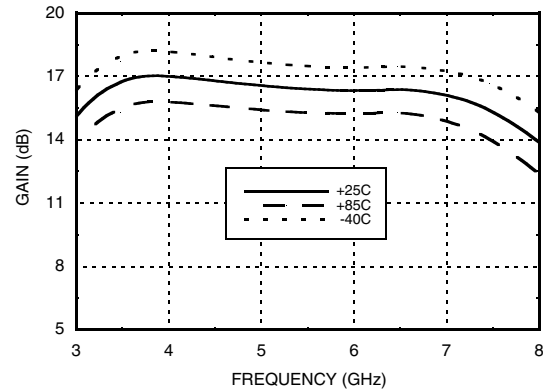
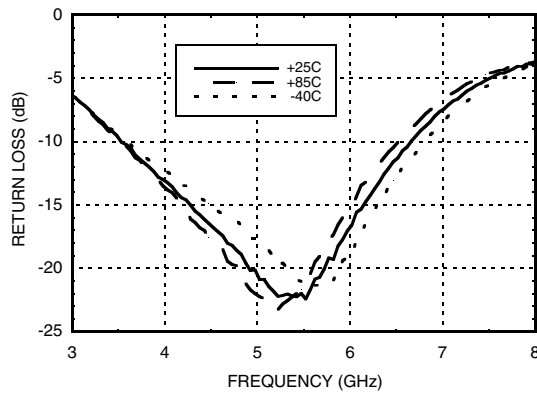
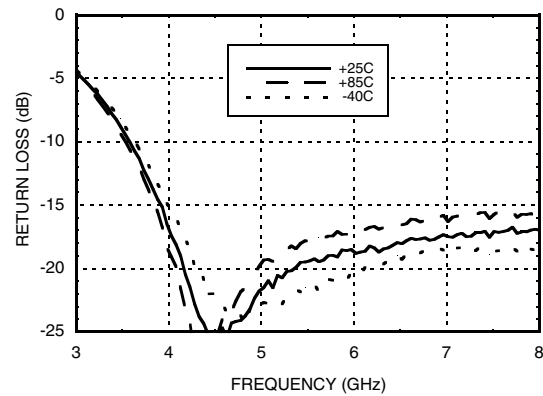
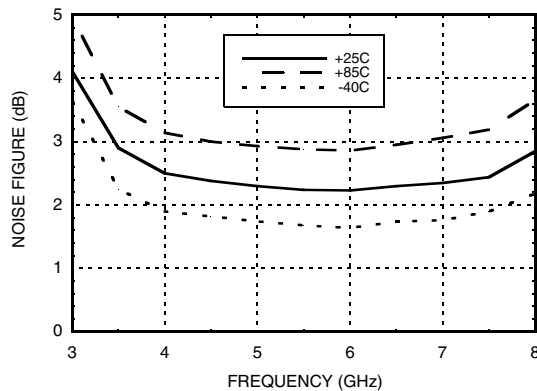
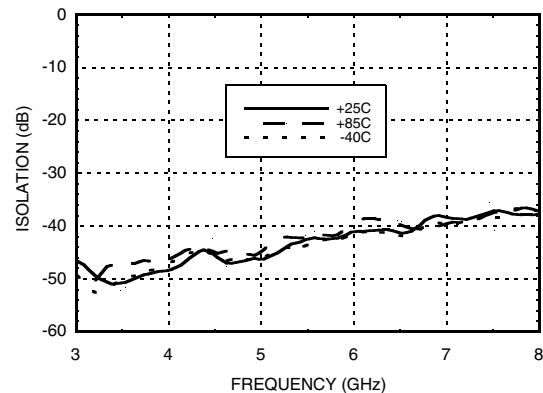

**Broadband Gain & Return Loss**

**Gain vs. Temperature**

**Input Return Loss vs. Temperature**

**Output Return Loss vs. Temperature**

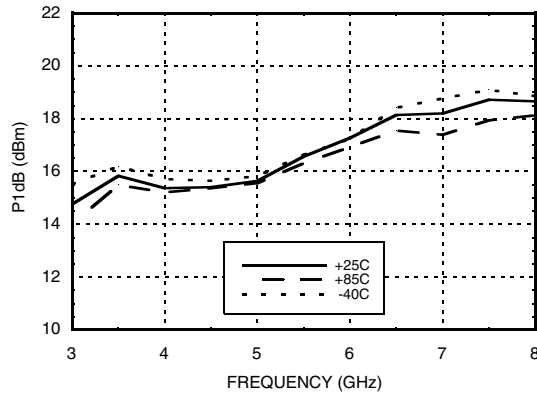
**Noise Figure vs. Temperature**

**Reverse Isolation vs. Temperature**



## GaAs MMIC LOW NOISE AMPLIFIER, 3.5 - 7.0 GHz

LOW NOISE AMPLIFIERS - SMT

**P1dB vs. Temperature**



**Psat vs. Temperature**

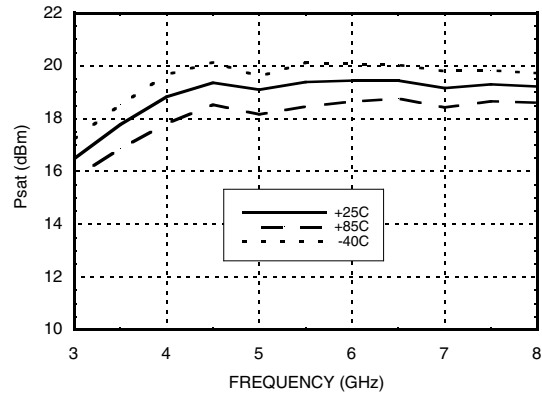

**Output IP3 vs. Temperature**

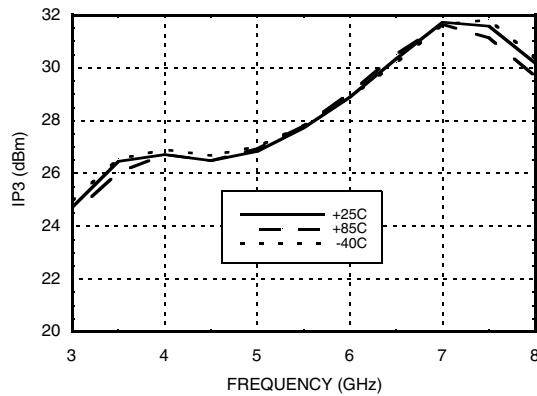

**Gain, Noise Figure & Power vs. Supply Voltage @ 5.5 GHz**

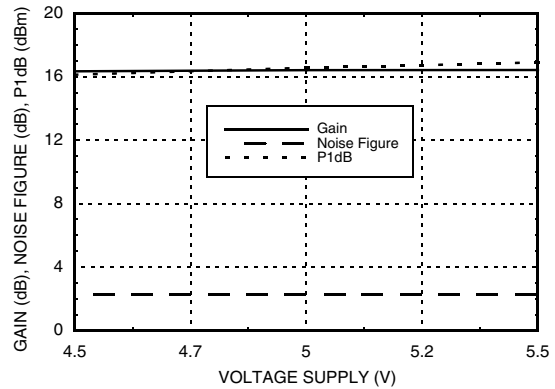

**Power Compression @ 5.5 GHz**

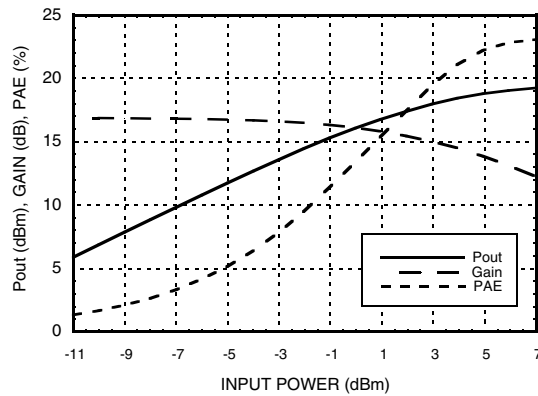



## GaAs MMIC LOW NOISE AMPLIFIER, 3.5 - 7.0 GHz

### Absolute Maximum Ratings

Drain Bias Voltage (Vdd)	+7 Vdc
RF Input Power (RFIN)(Vdd = +5.0 Vdc)	+11 dBm
Channel Temperature	175 °C
Continuous P <sub>diss</sub> (T= 85 °C) (derate 6.5 mW/°C above 85 °C)	0.42 W
Thermal Resistance (channel to ground paddle)	155 °C/W
Storage Temperature	-65 to +150 °C
Operating Temperature	-40 to +85 °C

### Typical Supply Current vs. Vdd

Vdd (V)	I <sub>dd</sub> (mA)
+4.5	54
+5.0	55
+5.5	56

Note: Amplifier will operate over full voltage ranges shown above.

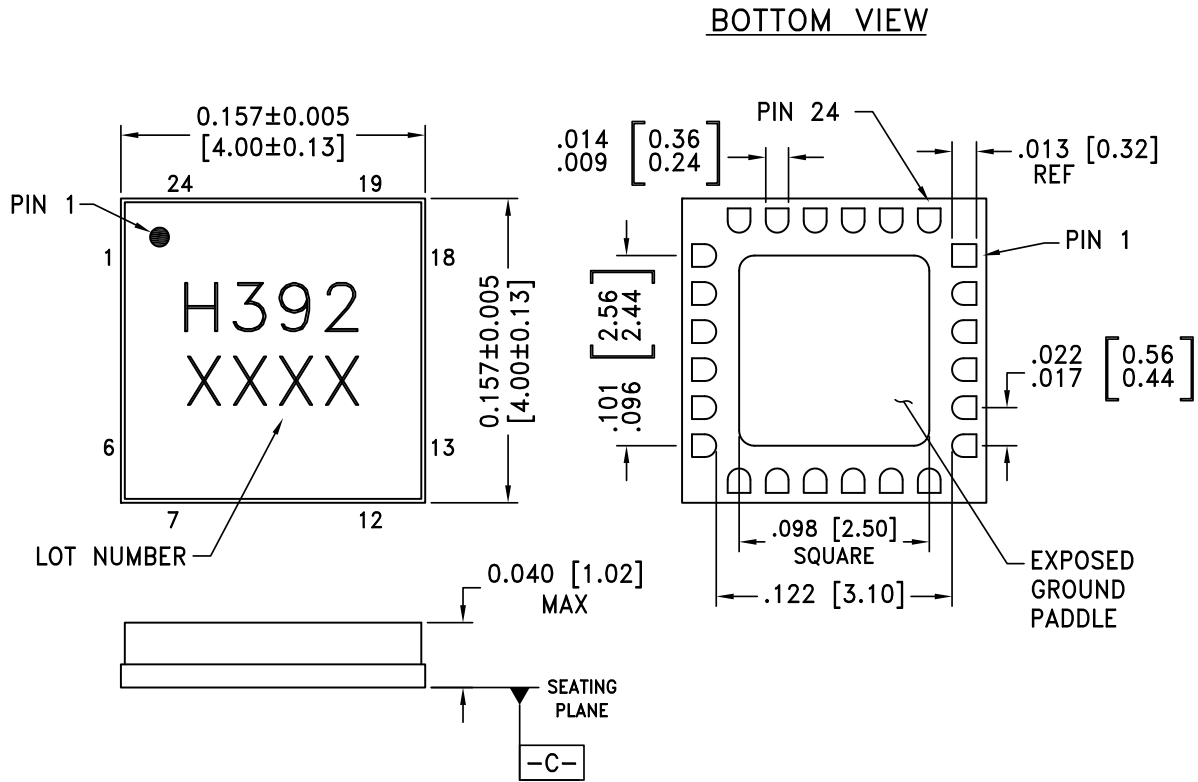

ELECTROSTATIC SENSITIVE DEVICE  
OBSERVE HANDLING PRECAUTIONS

**Outline Drawing**

**NOTES:**

1. PACKAGE BODY MATERIAL: ALUMINA.
2. LEAD AND GROUND PADDLE PLATING: 30-80 MICROINCHES GOLD OVER 50 MICROINCHES MINIMUM NICKEL.
3. DIMENSIONS ARE IN INCHES (MILLIMETERS).
4. LEAD SPACING TOLERANCE IS NON-CUMULATIVE.
5. CHARACTERS TO BE HELVETICA MEDIUM, .025 HIGH, BLACK INK, OR LASER MARK LOCATED APPROX. AS SHOWN.
6. PACKAGE WARP SHALL NOT EXCEED 0.05MM DATUM  $-C-$
7. ALL GROUND LEADS AND GROUND PADDLE MUST BE SOLDERED TO PCB RF GROUND.

**Package Information**

Part Number	Package Body Material	Lead Finish	MSL Rating	Package Marking <sup>[2]</sup>
HMC392LC4	Alumina, White	Gold over Nickel	MSL3 <sup>[1]</sup>	H392 XXXX

[1] Max peak reflow temperature of 260 °C

[2] 4-Digit lot number XXXX

**Pin Descriptions**

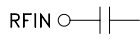
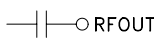
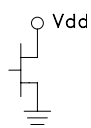
Pin Number	Function	Description	Interface Schematic
1, 5 - 14, 18 - 20, 22 - 24	N/C	No connection required. These pins may be connected to RF/DC ground without affecting performance.	
2, 4, 15, 17	GND	Package bottom has an exposed metal paddle that must also be connected to RF/DC ground.	
3	RFIN	This pin is AC coupled and matched to 50 Ohms.	
16	RFOUT	This pin is AC coupled and matched to 50 Ohms.	
21	Vdd	Power Supply Voltage for the amplifier. External bypass capacitors of 100 pF, 1000pF, and 2.2 μF are required.	

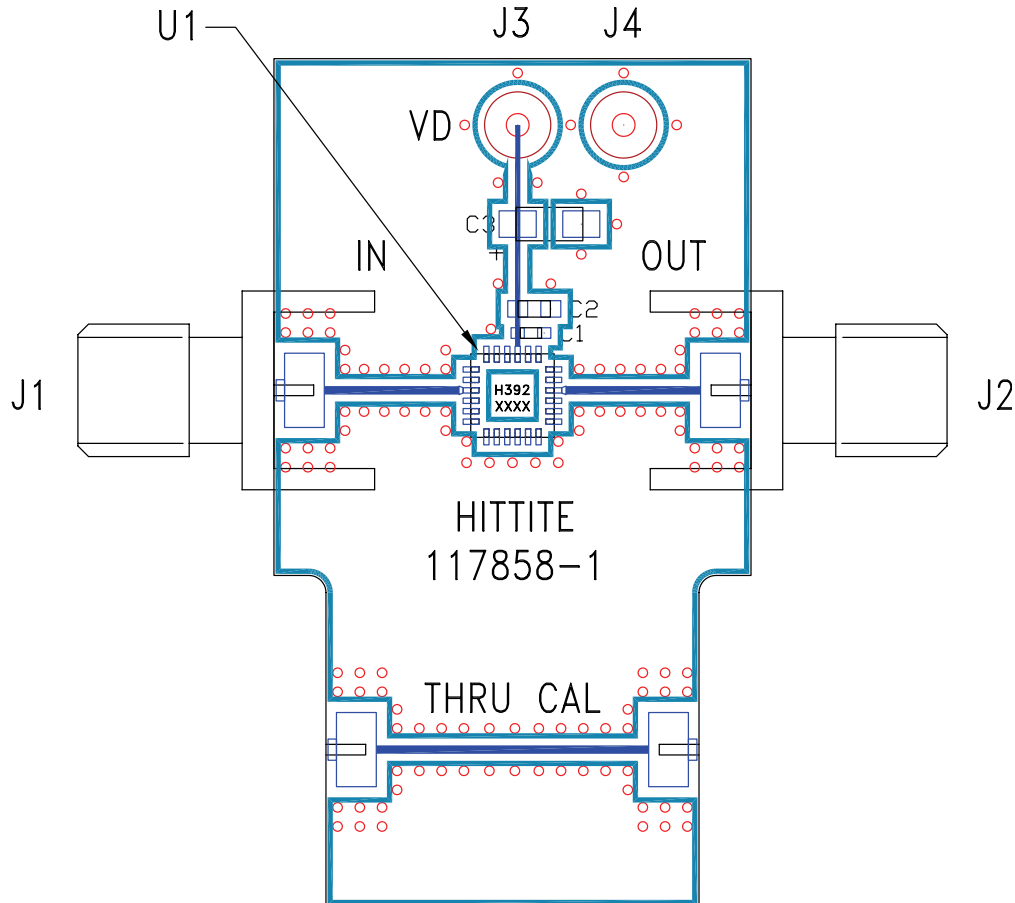
**Evaluation PCB**

**List of Materials for Evaluation PCB 117490 [1]**

Item	Description
J1, J2	SMA
J3 - J4	DC Pin
C1	100 pF capacitor, 0402 Pkg..
C2	1,000 pF Capacitor, 0603 Pkg..
C3	2.2μF Capacitor, Tantalum
U1	HMC392LC4 Amplifier
PCB [2]	117858 Evaluation PCB

[1] Reference this number when ordering complete evaluation PCB

[2] Circuit Board Material: Rogers 4350.

The circuit board used in this application should use RF circuit design techniques. Signal lines should have 50 Ohm impedance while the package ground leads and exposed paddle should be connected directly to the ground plane similar to that shown. A sufficient number of via holes should be used to connect the top and bottom ground planes. The evaluation board should be mounted to an appropriate heat sink. The evaluation circuit board shown is available from Hittite upon request.

