

1.25mm Spacing

SERIES

8370

NON-ZIF ライトアングル DIP 両面接点

LIF Right Angle Through Hole (Dual Sided Contact Type)

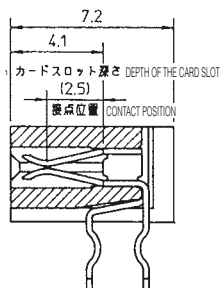
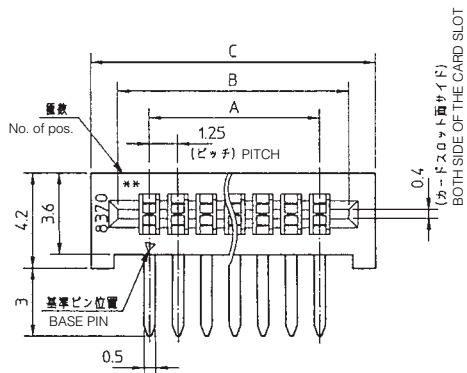

奇数ピン位置
POSITION OF ODD-NUMBERED PINS

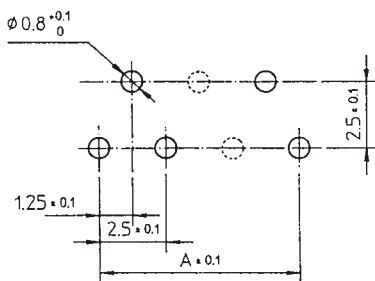
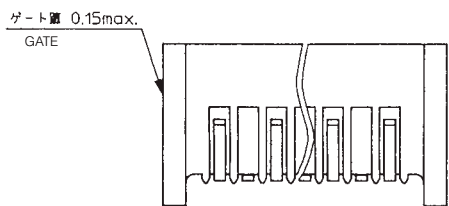
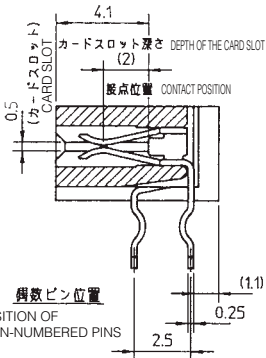

基板穴明寸法 (コネクタ搭載面) RECOMMENDED P.C. BOARD LAYOUT (View from connector mounting side)
(適用基板厚 t=1~1.6) APPLICABLE BOARD THICKNESS

寸法表 DIMENSIONS				収納数量 UNITS/TUBE
極数 No. of pos.	A	B	C	
4	3.75	6.41	8.75	55
5	5	7.66	10	48
6	6.25	8.91	11.25	43
7	7.5	10.16	12.5	38
8	8.75	11.41	13.75	35
9	10	12.66	15	32
10	11.25	13.91	16.25	29
11	12.5	15.16	17.5	27
12	13.75	16.41	18.75	25
13	15	17.66	20	24
14	16.25	18.91	21.25	22
15	17.5	20.16	22.5	21
16	18.75	21.41	23.75	20
17	20	22.66	25	19
18	21.25	23.91	26.25	18
19	22.5	25.16	27.5	17
20	23.75	26.41	28.75	16
21	25	27.66	30	16
22	26.25	28.91	31.25	15
23	27.5	30.16	32.5	14
24	28.75	31.41	33.75	14
25	30	32.66	35	13
26	31.25	33.91	36.25	13
27	32.5	35.16	37.5	12
28	33.75	36.41	38.75	12
29	35	37.66	40	12
30	36.25	38.91	41.25	11

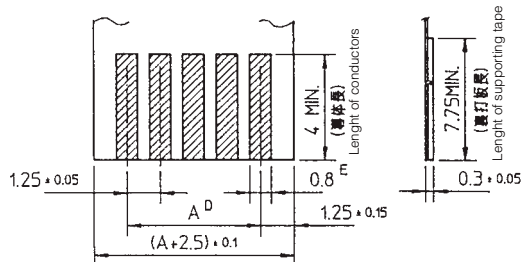

	公差 Tolerance	
	D	E
FPC	±0.05	±0.1
FFC	±0.1	±0.03

適用 FFC/FPC 寸法
APPLICABLE FPC/FFC

注文コード ORDERING CODE

00 8370 XX7 00X 800

- 0: トレー梱包
TRAY PACKAGE
- 1: マガジン
TUBE PACKAGE
- 極数 NUMBER OF POSITIONS

1.25mm Spacing

SERIES

8370

NON-ZIF ストレート DIP 両面接点

LIF Vertical Through Hole (Dual Sided Contact Type)

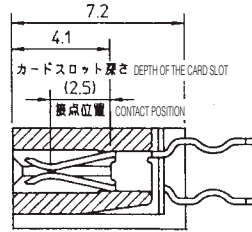
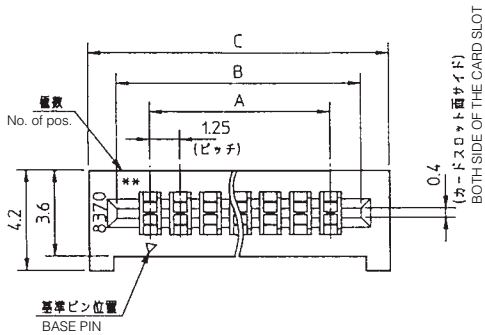

偶数ピン位置
POSITION OF EVEN-NUMBERED PINS

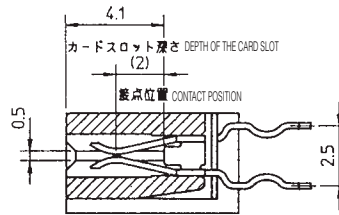

奇数ピン位置
POSITION OF ODD-NUMBERED PINS

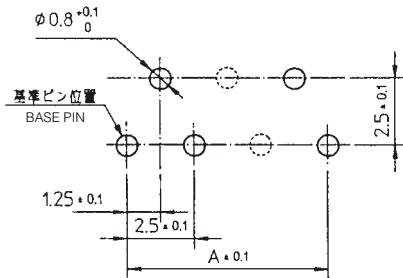
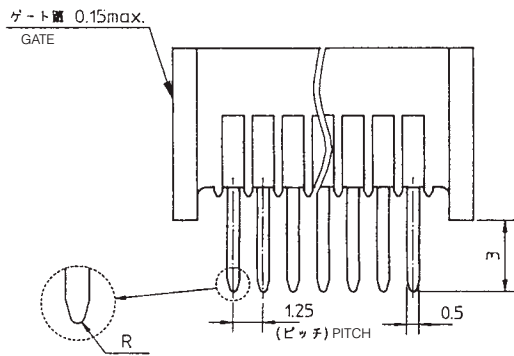

基板穴明寸法 (コネクタ搭載面) RECOMMENDED P.C. BOARD LAYOUT (View from connector mounting side)
(適用基板厚 t=1~1.6) APPLICABLE BOARD THICKNESS

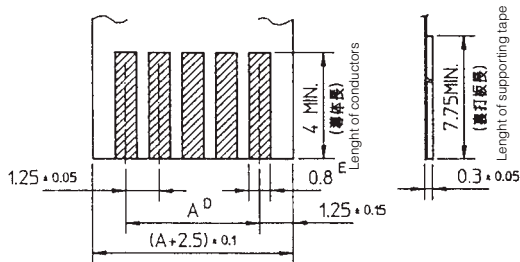

	公差 Tolerance	
	D	E
FPC	±0.05	±0.1
FFC	±0.1	±0.03

適用 FFC/FPC 寸法
APPLICABLE FPC/FFC

注文コード ORDERING CODE

00 8370 XX1 00X 800

- 0: トレー梱包
TRAY PACKAGE
 - 1: マガジン
TUBE PACKAGE
- 極数 NUMBER OF POSITIONS

極数 No. of pos.	寸法表 DIMENSIONS			収納数量 UNITS/TUBE
	A	B	C	
4	3.75	6.41	8.75	55
5	5	7.66	10	48
6	6.25	8.91	11.25	43
7	7.5	10.16	12.5	38
8	8.75	11.41	13.75	35
9	10	12.66	15	32
10	11.25	13.91	16.25	29
11	12.5	15.16	17.5	27
12	13.75	16.41	18.75	25
13	15	17.66	20	24
14	16.25	18.91	21.25	22
15	17.5	20.16	22.5	21
16	18.75	21.41	23.75	20
17	20	22.66	25	19
18	21.25	23.91	26.25	18
19	22.5	25.16	27.5	17
20	23.75	26.41	28.75	16
21	25	27.66	30	16
22	26.25	28.91	31.25	15
23	27.5	30.16	32.5	14
24	28.75	31.41	33.75	14
25	30	32.66	35	13
26	31.25	33.91	36.25	13
27	32.5	35.16	37.5	12
28	33.75	36.41	38.75	12
29	35	37.66	40	12
30	36.25	38.91	41.25	11