

## GaAs MMIC VOLTAGE-VARIABLE ATTENUATOR, 5 - 30 GHz

### Typical Applications

The HMC712 is ideal for:

- Point-to-Point Radio
- VSAT Radio
- Test Instrumentation
- Microwave Sensors
- Military, ECM & Radar

### Functional Diagram

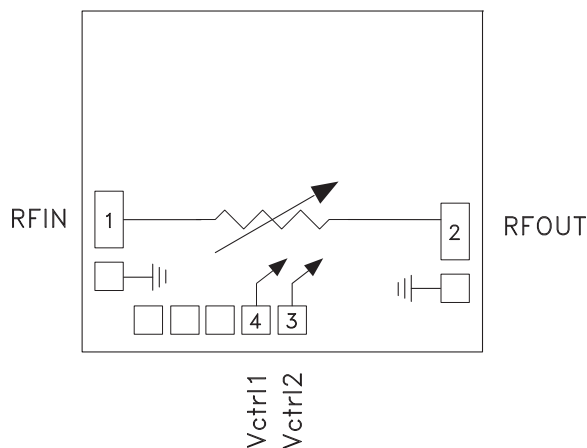

### Features

- Wide Bandwidth: 5 - 30 GHz
- Excellent Linearity: +28 dBm Input P1dB
- Wide Attenuation Range: 30 dB
- Compact Die Size: 1.4 x 1.2 x 0.1 mm

### General Description

The HMC712 die is an absorptive Voltage Variable Attenuator (VVA) which operates from 5 - 30 GHz and is ideal in designs where an analog DC control signal must be used to control RF signal levels over a 30 dB amplitude range. It features two shunt-type attenuators which are controlled by two analog voltages, Vctrl1 and Vctrl2. Optimum linearity performance of the attenuator is achieved by first varying Vctrl1 of the 1st attenuation stage from -3V to 0V with Vctrl2 fixed at -3V. The control voltage of the 2nd attenuation stage, Vctrl2, should then be varied from -3V to 0V, with Vctrl1 fixed at 0V.

However, if the Vctrl1 and Vctrl2 pins are connected together it is possible to achieve the full analog attenuation range with only a small degradation in input IP3 performance. Applications include AGC circuits and temperature compensation of multiple gain stages in microwave point-to-point and VSAT radios.

### Electrical Specifications, $T_A = +25^\circ \text{C}$ , 50 Ohm system

Parameter	Min.	Typ.	Max.	Units
Insertion Loss	5 - 16 GHz	2.5		dB
	16 - 24 GHz	3.5		dB
	24 - 30 GHz	4.5		dB
Attenuation Range		30		dB
Input Return Loss		12		dB
Output Return Loss		10		dB
Input Power for 1 dB Compression (any attenuation)		28		dBm
Input Third Order Intercept (Two-tone Input Power = 10 dBm Each Tone)		32		dBm

**GaAs MMIC VOLTAGE-VARIABLE  
ATTENUATOR, 5 - 30 GHz**

**Attenuation vs. Frequency over Vctrl**  
Vctrl1 = Variable, Vctrl2 = -3V

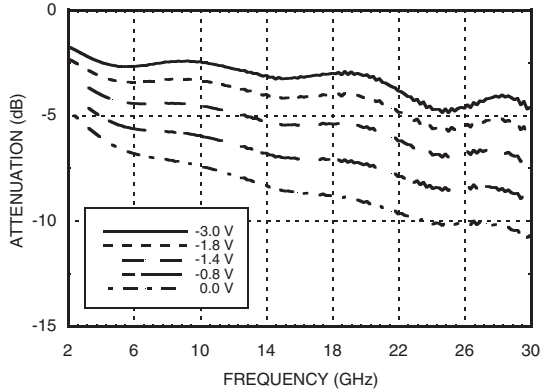

**Attenuation vs. Frequency over Vctrl**  
Vctrl1 = 0V, Vctrl2 = Variable

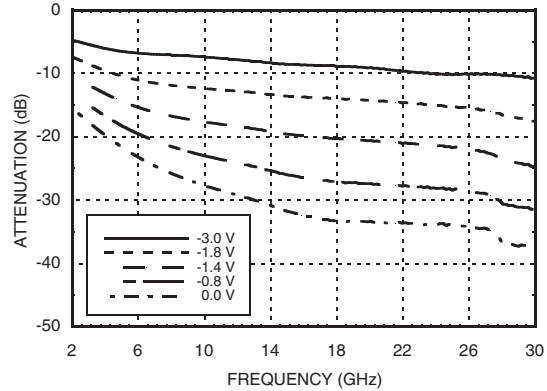

**Attenuation vs. Vctrl1**  
Over Temperature @ 10 GHz, Vctrl2 = -3V

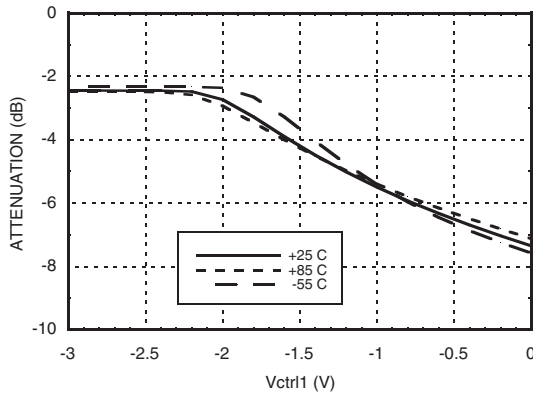

**Attenuation vs. Vctrl2**  
Over Temperature @ 10 GHz, Vctrl1 = 0V

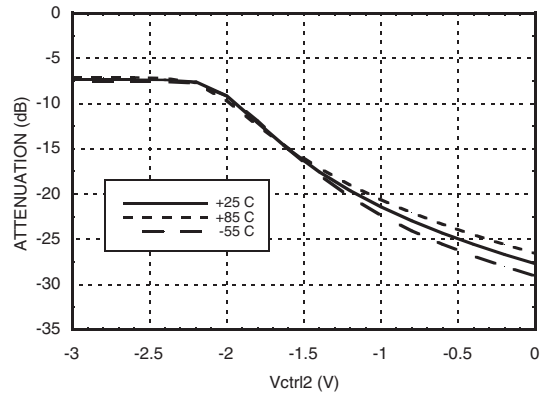

**Attenuation vs. Pin @ 10 GHz**  
Vctrl1 = Variable, Vctrl2 = -3V

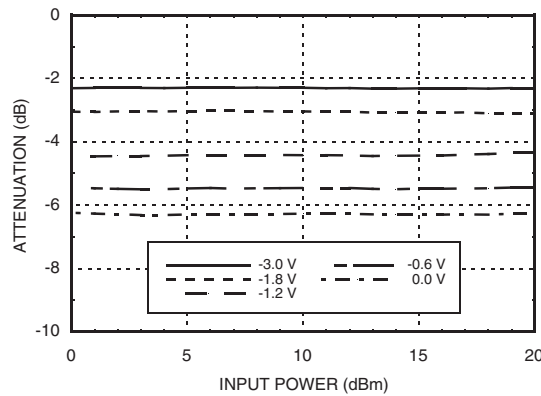

**GaAs MMIC VOLTAGE-VARIABLE  
ATTENUATOR, 5 - 30 GHz**

1

ATTENUATORS - ANALOG - CHIP

**Insertion Phase vs. Vctrl1, Vctrl2 = -3V**

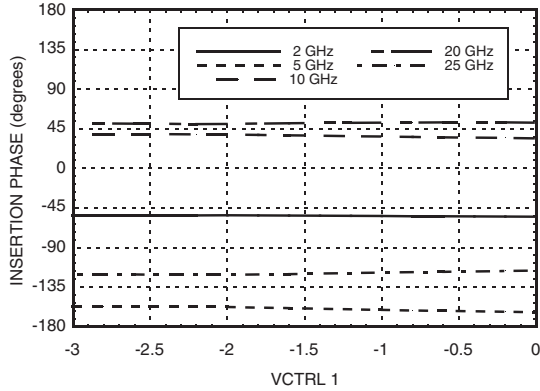

**Insertion Phase vs. Vctrl2, Vctrl1 = 0V**

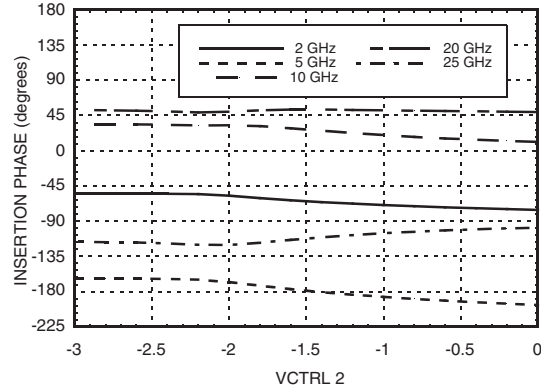

**Input Return Loss  
Vctrl1 = Variable, Vctrl2 = -3V**

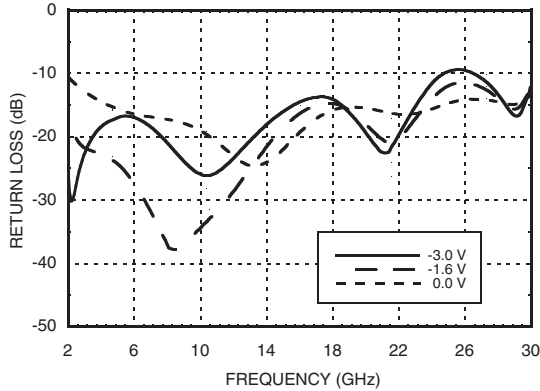

**Input Return Loss  
Vctrl1 = 0V, Vctrl2 = Variable**

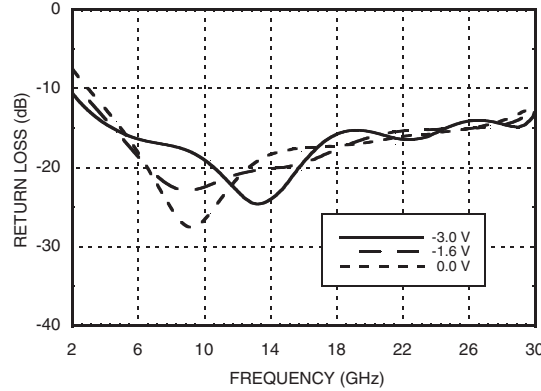

**Output Return Loss  
Vctrl1 = Variable, Vctrl2 = -3V**

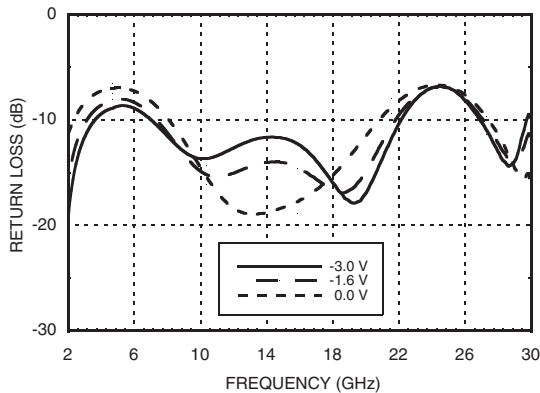

**Output Return Loss  
Vctrl1 = 0V, Vctrl2 = Variable**

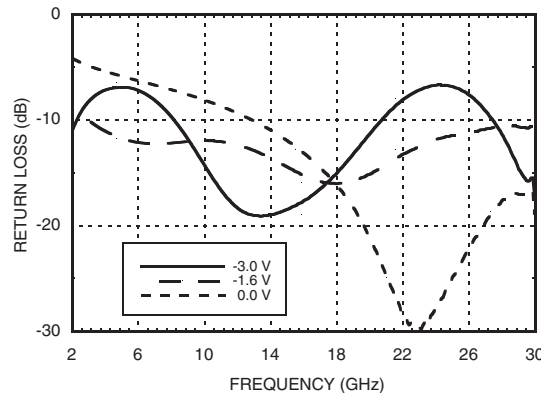

**GaAs MMIC VOLTAGE-VARIABLE  
ATTENUATOR, 5 - 30 GHz**

**Input IP3 vs Input Power @ 10 GHz**  
**Vctrl1 = Variable, Vctrl2 = -3V**

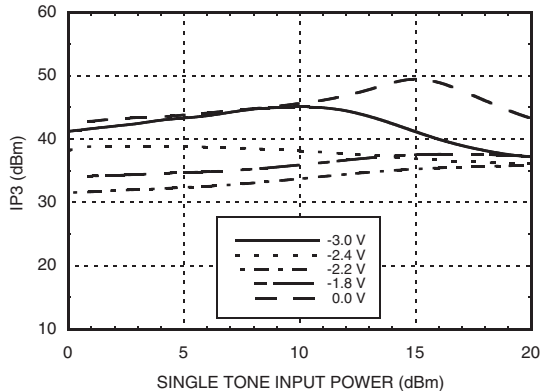

**Input IP3 vs. Input Power Over Frequency**  
**Vctrl1 = -2.2V, Vctrl2 = -3V (Worst Case IP3)**

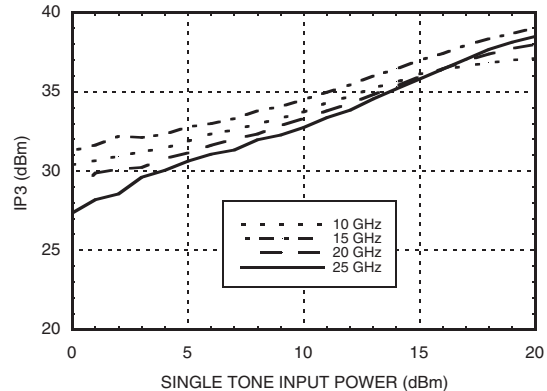

**Input IP3 vs. Input Power Over Temperature**  
**@ 10 GHz, Vctrl1 = -2.2V, Vctrl2 = -3V**

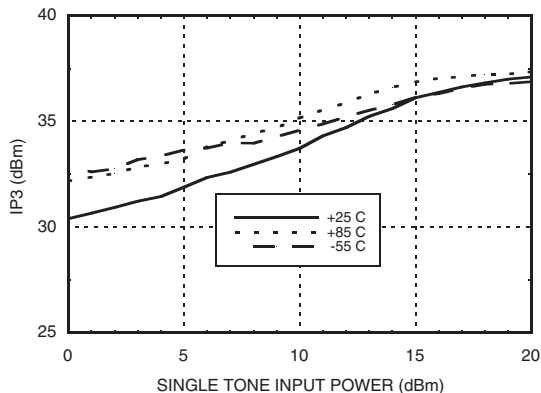

**Attenuation vs. Frequency over Vctrl**  
**Vctrl1 = Vctrl2**

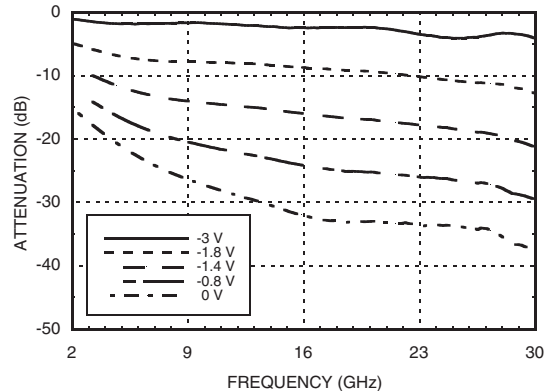

**Attenuation vs. Vctrl over Temperature**  
**@ 10 GHz, Vctrl1 = Vctrl2**

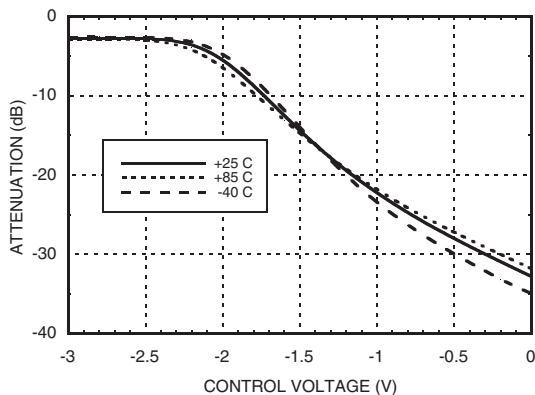

**Attenuation vs. Input Power over Vctrl**  
**Vctrl1 = Vctrl2**

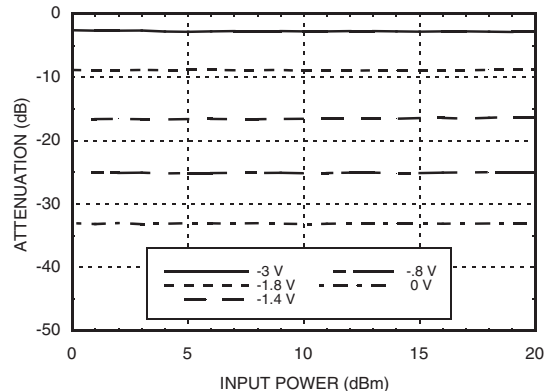

**GaAs MMIC VOLTAGE-VARIABLE  
ATTENUATOR, 5 - 30 GHz**

1

ATTENUATORS - ANALOG - CHIP

**Input Return Loss, Vctrl1 = Vctrl2**

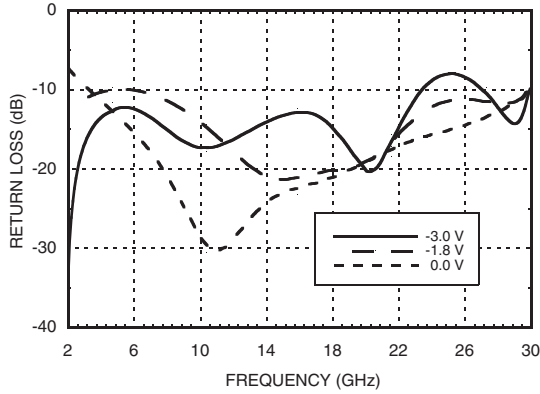

**Output Return Loss, Vctrl1 = Vctrl2**

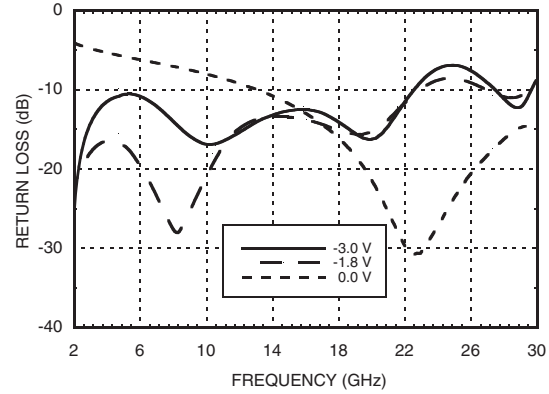

**Input IP3 vs. Input Power Over  
Vctrl @ 10 GHz, Vctrl1 = Vctrl2**

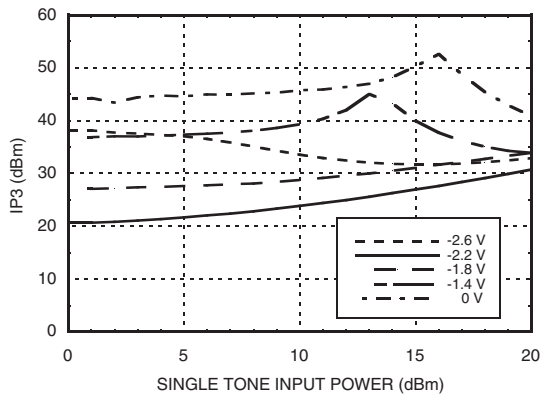

**Absolute Maximum Ratings**

RF Input Power	+30 dBm
Control Voltage Range	+1 to -5V
Channel Temperature	150 °C
Thermal Resistance (Channel to die bottom)	64 °C/W
Storage Temperature	-65 to +150 °C
Operating Temperature	-55 to +85 °C

**Control Voltages**

Vctrl1	-3 to 0V @ 10 µA
Vctrl2	-3 to 0V @ 10 µA



**ELECTROSTATIC SENSITIVE DEVICE  
OBSERVE HANDLING PRECAUTIONS**

**GaAs MMIC VOLTAGE-VARIABLE  
ATTENUATOR, 5 - 30 GHz**

**Outline Drawing**

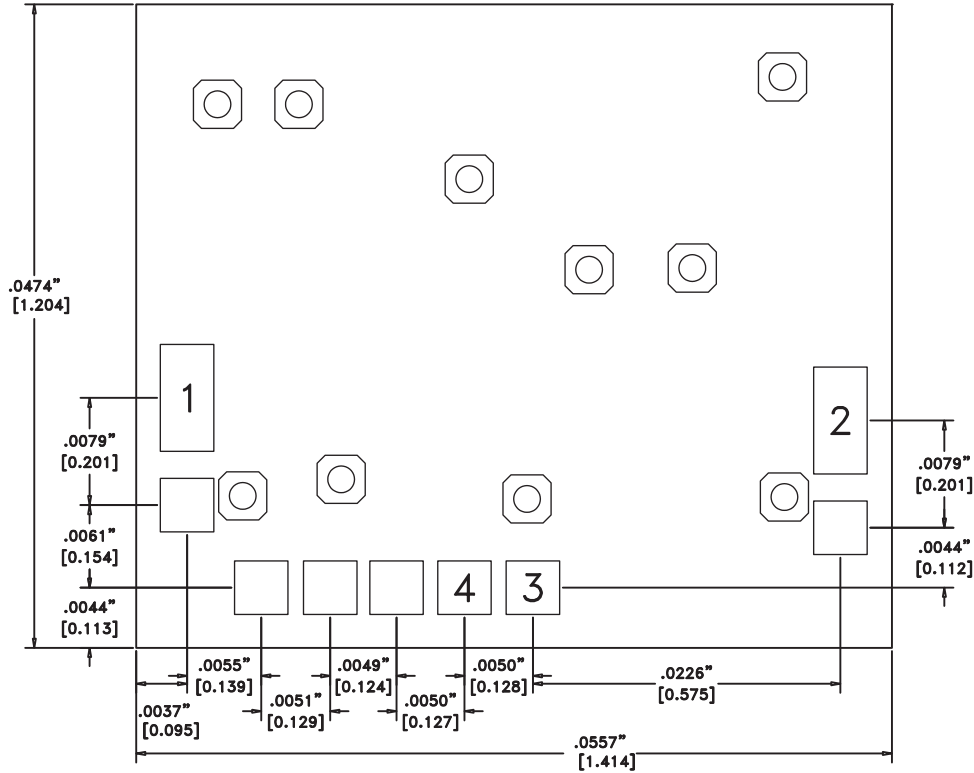

**Die Packaging Information** [1]

Standard	Alternate
GP-2 (Gel Pack)	[2]

[1] Refer to the "Packaging Information" section for die packaging dimensions.

[2] For alternate packaging information contact Hittite Microwave Corporation.

1. ALL DIMENSIONS ARE IN INCHES (MILLIMETERS).
2. TYPICAL BOND PAD IS .004" SQUARE.
3. TYPICAL BOND PAD SPACING IS .006" CENTER TO CENTER EXCEPT AS NOTED.
4. BACKSIDE METALIZATION: GOLD
5. BACKSIDE METAL IS GROUND
6. BOND PAD METALIZATION: GOLD

**GaAs MMIC VOLTAGE-VARIABLE  
ATTENUATOR, 5 - 30 GHz**

**Pad Descriptions**

Pad Number	Function	Description	Interface Schematic
1	RFIN	This pad is DC coupled and matched to 50 Ohms. A blocking capacitor is required if RF line potential is not equal to 0V.	
2	RFOUT		
3	Vctrl2	Control Voltage 2	
4	Vctrl1	Control Voltage 1	
	GND	Die bottom must be connected to RF/DC ground.	

**Assembly Diagram**

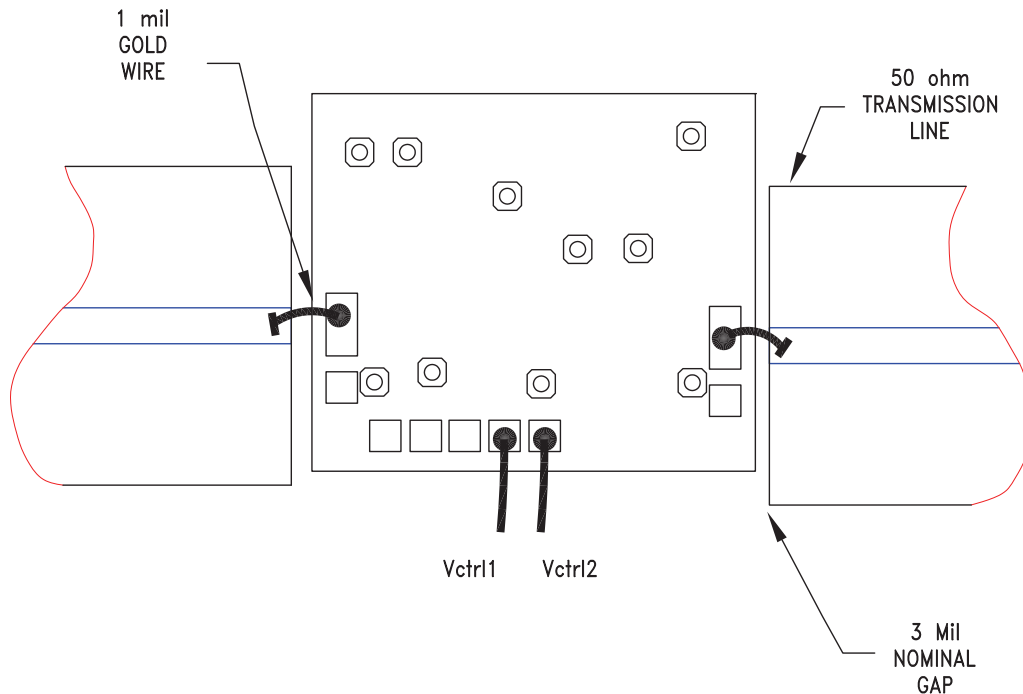

**GaAs MMIC VOLTAGE-VARIABLE  
ATTENUATOR, 5 - 30 GHz**

**Mounting & Bonding Techniques for Millimeterwave GaAs MMICs**

The die should be attached directly to the ground plane eutectically or with conductive epoxy (see HMC general Handling, Mounting, Bonding Note).

50 Ohm Microstrip transmission lines on 0.127mm (5 mil) thick alumina thin film substrates are recommended for bringing RF to and from the chip (Figure 1). If 0.254mm (10 mil) thick alumina thin film substrates must be used, the die should be raised 0.150mm (6 mils) so that the surface of the die is coplanar with the surface of the substrate. One way to accomplish this is to attach the 0.102mm (4 mil) thick die to a 0.150mm (6 mil) thick molybdenum heat spreader (moly-tab) which is then attached to the ground plane (Figure 2).

Microstrip substrates should be brought as close to the die as possible in order to minimize bond wire length. Typical die-to-substrate spacing is 0.076mm to 0.152 mm (3 to 6 mils).

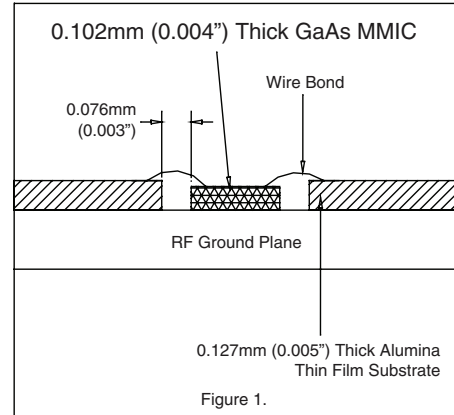

**Handling Precautions**

Follow these precautions to avoid permanent damage.

**Storage:** All bare die are placed in either Waffle or Gel based ESD protective containers, and then sealed in an ESD protective bag for shipment. Once the sealed ESD protective bag has been opened, all die should be stored in a dry nitrogen environment.

**Cleanliness:** Handle the chips in a clean environment. DO NOT attempt to clean the chip using liquid cleaning systems.

**Static Sensitivity:** Follow ESD precautions to protect against ESD strikes.

**Transients:** Suppress instrument and bias supply transients while bias is applied. Use shielded signal and bias cables to minimize inductive pick-up.

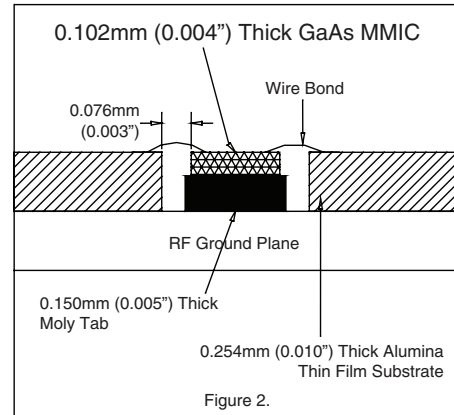

**General Handling:** Handle the chip along the edges with a vacuum collet or with a sharp pair of bent tweezers. The surface of the chip may have fragile air bridges and should not be touched with vacuum collet, tweezers, or fingers.

**Mounting**

The chip is back-metallized and can be die mounted with AuSn eutectic preforms or with electrically conductive epoxy. The mounting surface should be clean and flat.

**Eutectic Die Attach:** A 80/20 gold tin preform is recommended with a work surface temperature of 255 °C and a tool temperature of 265 °C. When hot 90/10 nitrogen/hydrogen gas is applied, tool tip temperature should be 290 °C. DO NOT expose the chip to a temperature greater than 320 °C for more than 20 seconds. No more than 3 seconds of scrubbing should be required for attachment.

**Epoxy Die Attach:** Apply a minimum amount of epoxy to the mounting surface so that a thin epoxy fillet is observed around the perimeter of the chip once it is placed into position. Cure epoxy per the manufacturer's schedule.

**Wire Bonding**

Ball or wedge bond with 0.025mm (1 mil) diameter pure gold wire. Thermosonic wirebonding with a nominal stage temperature of 150 °C and a ball bonding force of 40 to 50 grams or wedge bonding force of 18 to 22 grams is recommended. Use the minimum level of ultrasonic energy to achieve reliable wirebonds. Wirebonds should be started on the chip and terminated on the package or substrate. All bonds should be as short as possible <0.31mm (12 mils).