

TO-92 Plastic-Encapsulate Transistors

AV1959 TRANSISTOR (NPN)

FEATURES

Power dissipation

$$P_{CM} : 0.5 \text{ W (} T_{amb}=25^{\circ}\text{C)}$$

Collector current

$$I_{CM} : 0.5 \text{ A}$$

Collector-base voltage

$$V_{(BR)CBO} : 35 \text{ V}$$

Operating and storage junction temperature range

$$T_{stg}: -55^{\circ}\text{C to } +150^{\circ}\text{C}$$

$$T_j: 150^{\circ}\text{C}$$

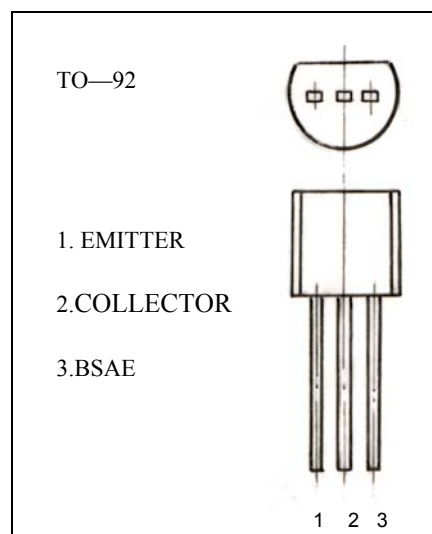

ELECTRICAL CHARACTERISTICS ($T_{amb}=25^{\circ}\text{C}$ unless otherwise specified)

Parameter	Symbol	Test conditions	MIN	TYP	MAX	UNIT
Collector-base breakdown voltage	$V_{(BR)CBO}$	$I_C = 100 \mu\text{A}, I_E = 0$	35			V
Collector-emitter breakdown voltage	$V_{(BR)CEO}$	$I_C = 0.1 \text{ mA}, I_B = 0$	30			V
Emitter-base breakdown voltage	$V_{(BR)EBO}$	$I_E = 100 \mu\text{A}, I_C = 0$	5			V
Collector cut-off current	I_{CBO}	$V_{CB} = 35 \text{ V}, I_E = 0$			0.1	μA
Emitter cut-off current	I_{EBO}	$V_{EB} = 5 \text{ V}, I_C = 0$			0.1	μA
DC current gain	$H_{FE(1)}$	$V_{CE} = 1\text{V}, I_C = 0$	70		400	
	$H_{FE(2)}$	$V_{CE} = 6\text{V}, I_C = 400\text{mA}$	25			
Collector-emitter saturation voltage	$V_{CE(sat)}$	$I_C = 100\text{mA}, I_B = 10\text{mA}$			0.25	V
Base-emitter voltage	V_{BE}	$V_{CE} = 1\text{V}, I_C = 100\text{mA}$			1.0	V
Transition frequency	f_T	$V_{CE} = 6 \text{ V}, I_C = 20\text{mA}$	200			MHz

CLASSIFICATION OF H_{FE}

Rank		O	Y	GR
Range	$H_{FE(1)}$	70-140	120-240	200-400
	$H_{FE(2)}$	25(min)	40(min)	

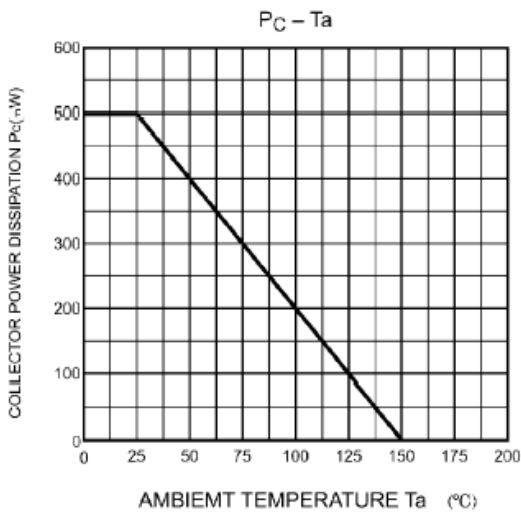
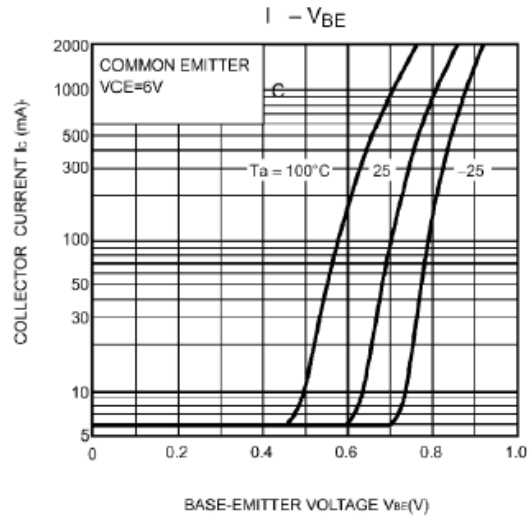
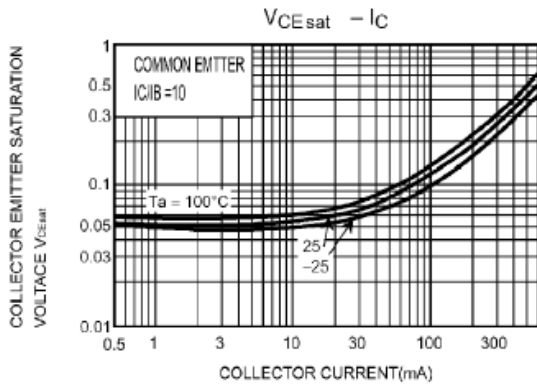
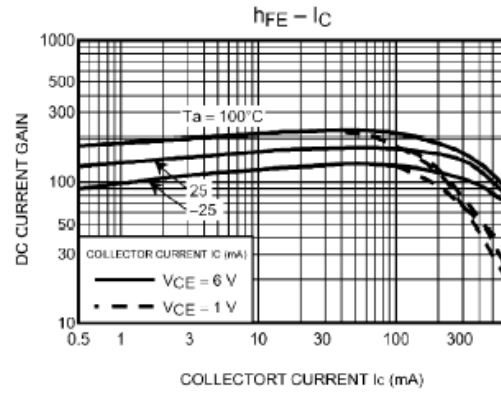
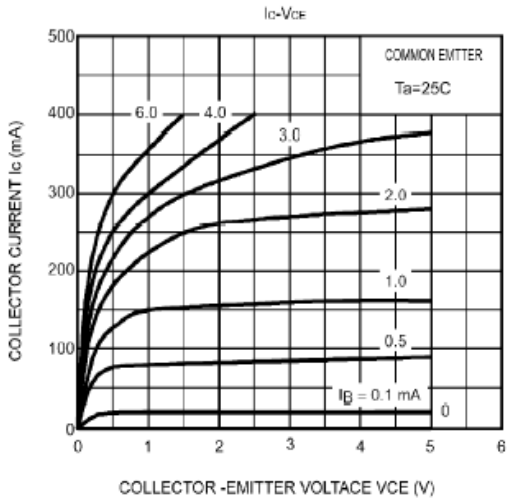

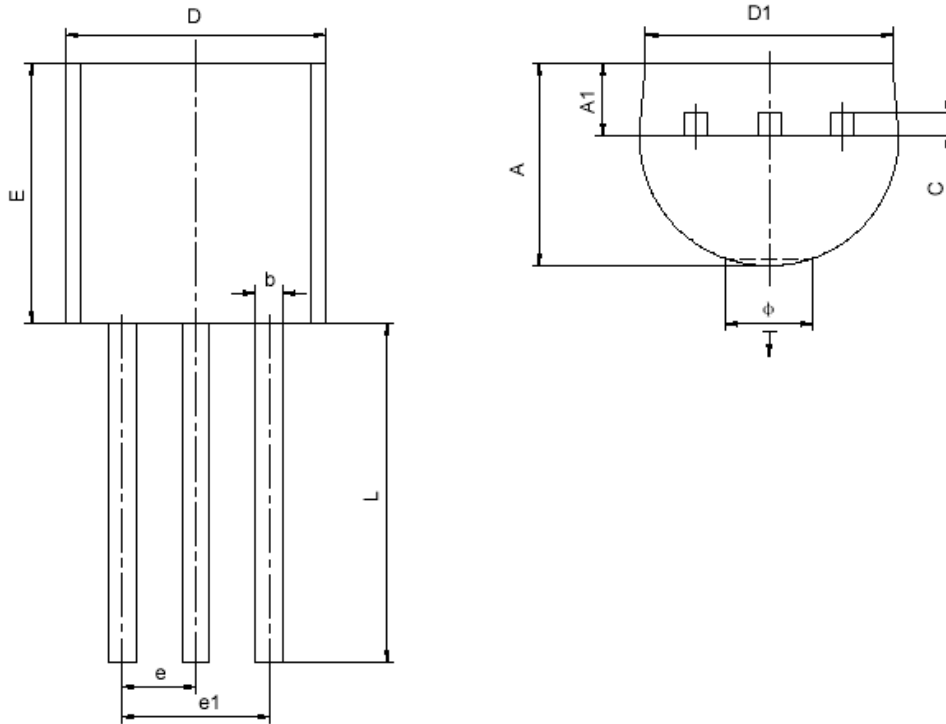

Symbol	Dimensions In Millimeters		Dimensions In Inches	
	Min	Max	Min	Max
A	3.300	3.700	0.130	0.146
A1	1.100	1.400	0.043	0.055
b	0.380	0.550	0.015	0.022
c	0.360	0.510	0.014	0.020
D	4.400	4.700	0.173	0.185
D1	3.430		0.135	
E	4.300	4.700	0.169	0.185
e	1.270TYP		0.050TYP	
e1	2.440	2.640	0.096	0.104
L	14.100	14.500	0.555	0.571
ϕ		1.600		0.063
T	0.000	0.380	0.000	0.015