



Altech is pleased to announce a new, more extensive printed circuit board terminal block line. This line offers the standard single and double level fixed and pluggable terminal blocks in metric and US pin spacings. However, this product line goes beyond our past standard offering. There is now a wider array of products within each pin spacing as well as new types of blocks such as 35°, reverse horizontal wire entry, and triple level fixed blocks, card edge connectors, panel feed through blocks, barrier strips, and plugs/headers with screw flanges. This product assortment combined with the new pricing structure makes this line extremely competitive.

Altech printed circuit board terminal blocks give you highly dependable connections without the need for wire lugs. Choose either tubular screw clamps or box clamps when economy is paramount or screw-cage clamps for heavy-duty applications. In each case, simply strip and insert the wire and tighten the screw. We recommend the use of ferrules, especially for export applications and whenever fine stranded wires must be terminated.

Our board mounted terminal blocks meet or exceed most international standards and are accepted worldwide. They're available in single, double and triple level configurations with both, millimeter and inch pin spacings. All leave mini footprints to save valuable real estate.

PRINTED CIRCUIT BOARD TERMINAL BLOCKS

FIXED

Our printed circuit board terminal blocks designed for fixed mounting offer high density, and maximum flexibility. Modular construction simplifies ordering and reduces inventory. Two- and 3-pole modules can be interlocked to create multipole assemblies. Altech can also supply ready-made assemblies tailored to your specification. Fixed-mount blocks are available with the economical tubular screw, box clamp or the screw-cage clamp and offer several wire entry options to facilitate wiring and increase accessibility.

PLUGGABLE

The two-piece, plug and header design of our “pluggable” terminal blocks speed and simplify board replacement and reduce costly downtime and misconnections. No special tools are required. Headers are soldered into the board and accept the plugs, which are easily removed for fast, convenient board or device replacement. Choose single- mold designs for maximum strength. Or choose modular designs which are assembled from 2 and 3 pole modules when you need maximum flexibility to meet changing requirements. Both are available in a variety of configurations. Headers are available in vertical, and horizontal, single or double-level, with closed or open ends.

We offer pluggables with either screw-cage clamp termination for heavy duty requirements or with tubular screw termination and open headers for cost sensitive applications. We also offer a card edge connector for a quick, reliable and inexpensive connection.

CONNECTION

Altech's printed circuit board terminal blocks give you a choice between tubular screw, box clamp and screw-cage clamp designs:

- When your application calls for the highest reliability and frequent wire terminations, the screw-cage clamp should be your choice. As the clamp is tightened, the nickel-plated cage rises, pressing the wire firmly against the busbar, ensuring solid connections every time. Standard color is green.
- In the tubular screw and box clamp design, tightening the screw presses the conductor directly against the bottom of the clamp. These systems are ideal for cost sensitive, lighter duty applications or applications with infrequent wire terminations. Wire protectors are standard. Standard color is black for tubular screw and green for box clamp.

PIN SPACING

Each clamp style is offered in metric and inch pin spacing. For your convenience, this catalog is organized by pin spacing. Fixed blocks are first, starting with the smallest pin spacing, then pluggable shown in each available spacing.

MATERIALS

All of our printed circuit board terminal blocks feature precision formed or machined metal parts which are electrolytically plated. Nickel or tin-plated brass cage clamps or tubes, wire protectors, and tin-plated solder pins satisfy the most demanding requirements. Housings are precision-molded from self-extinguishing polyamid 6.8 or glass-filled polyester providing excellent strength and temperature resistance.

MARKING

Altech offers marking to identify terminal inputs. Order Hot Stamp Imprinting for permanent marking of large quantities or custom marked terminals. Standard marking is consecutive numbers, left to right. This standard marking can be ordered by adding the imprint sequence to the part number as a suffix (i.e. MV-4612/1-12 would be a MV-4612 terminal block imprinted 1 through 12, left to right).

Custom imprints are also available, consult Altech for ordering information.



Fixed PCB Blocks

Pin Spacing: 3.50mm
 Orientation: Vertical*
 Clamp Type: Tubular Screw with Wire Protector
 Design: Modular



MLK-13

ELECTRICAL

	Current	Voltage	Wire Range
US Pending	10A	300V	30-16AWG
	10A	130V	1.0mm ² stranded 1.5mm ² solid

INSTALLATION DATA

Screw Size	M2	PCB Hole Size	1.3mm
Torque	0.2Nm (1.8 lbf-in.)	Stripping Lgth.	6.0mm

MATERIAL

Body	Polyamide	Screw	Galvanized Steel
Flammability Class	UL94V-0	Terminal	Tin-Plated Brass
Temperature Limit	85°C	Clamp	Tin-Plated Bronze
Color	Green		

No. Poles	Cat. #	Length (B) (mm)	Std. Pk.
2	MLK-132	7.0	100
3	MLK-133	10.5	100
4	MLK-134	14.0	50
5	MLK-135	17.5	50
6	MLK-136	21.0	50
7	MLK-137	24.5	50
8	MLK-138	28.0	50
9	MLK-139	31.5	50
10	MLK-1310	35.0	50
11	MLK-1311	38.5	50
12	MLK-1312	42.0	50
13	MLK-1313	45.5	20
14	MLK-1314	49.0	20
15	MLK-1315	52.5	20
16	MLK-1316	56.0	20
17	MLK-1317	59.5	20
18	MLK-1318	63.0	20
19	MLK-1319	66.5	20
20	MLK-1320	70.0	20
21	MLK-1321	73.5	20
22	MLK-1322	77.0	20
23	MLK-1323	80.5	20
24	MLK-1324	84.0	20

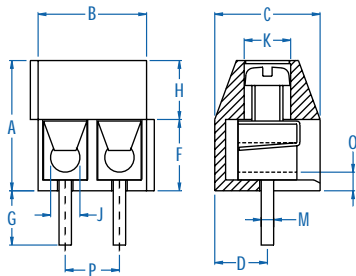

Dimensions

A	8.40 mm	I	-
B	7.00 mm	J	1.80 mm
C	6.80 mm	K	2.80 mm
D	3.40 mm	L	-
E	-	M	Ø0.80 mm
F	4.70 mm	N	-
G	3.50 mm	O	1.20 mm
H	3.80 mm	P	3.50 mm

*Also available in horizontal orientation

Pin Spacing: 3.81mm
 Orientation: Vertical
 Clamp Type: Screw Cage
 Design: Modular

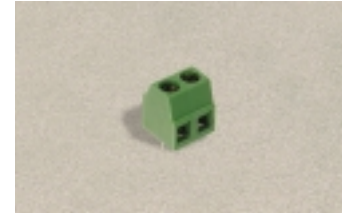

MCK-13

ELECTRICAL

	Current	Voltage	Wire Range
US Pending	10A	300V	30-16AWG
	10A	130V	1.0mm ² stranded 1.5mm ² solid

INSTALLATION DATA

Screw Size	M2	PCB Hole Size	1.3mm
Torque	0.2Nm (1.8 lbf-in.)	Stripping Lgth.	6.0mm

MATERIAL

Body	Polyamide	Screw	Galvanized Steel
Flammability Class	UL94V-0	Terminal	Tin-Plated Brass
Temperature Limit	85°C	Clamp	Nickel Bronze
Color	Green		

No. Poles	Cat. #	Length (B) (mm)	Std. Pk.
2	MCK-132	7.6	100
3	MCK-133	11.4	100
4	MCK-134	15.2	50
5	MCK-135	19.1	50
6	MCK-136	22.9	50
7	MCK-137	26.7	50
8	MCK-138	30.5	50
9	MCK-139	34.3	50
10	MCK-1310	38.1	50
11	MCK-1311	41.9	50
12	MCK-1312	45.7	50
13	MCK-1313	49.5	20
14	MCK-1314	53.3	20
15	MCK-1315	57.2	20
16	MCK-1316	61.0	20
17	MCK-1317	64.8	20
18	MCK-1318	68.6	20
19	MCK-1319	72.4	20
20	MCK-1320	76.2	20
21	MCK-1321	80.0	20
22	MCK-1322	83.8	20
23	MCK-1323	87.6	20
24	MCK-1324	91.4	20

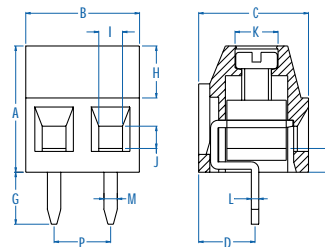

Dimensions

A	8.50 mm	I	1.60 mm
B	7.62 mm	J	1.50 mm
C	7.40 mm	K	2.75 mm
D	3.80 mm	L	0.50 mm
E	-	M	0.90 mm
F	-	N	-
G	3.50 mm	O	1.40 mm
H	5.90 mm	P	3.81 mm

Fixed PCB Blocks



Pin Spacing: 5.00mm
 Orientation: Vertical
 Clamp Type: Box with Wire Protector
 Design: Modular

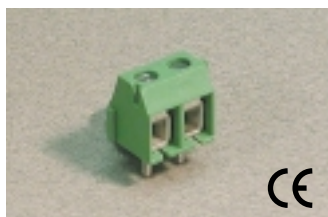

MBE-15

ELECTRICAL

	Current	Voltage	Wire Range
	10A	300V	30-16AWG
	17.5A	450V	1.5mm ² Stranded 2.5mm ² Solid

INSTALLATION DATA

Screw Size	M2.5	PCB Hole Size	1.5mm
Torque	0.4Nm (3.6 lbf-in.)	Stripping Lgth.	7.1mm

MATERIAL

Body	PA6.8	Screw	Galvanized Steel
Flammability Class	UL94V-0	Terminal	Tin-Plated Brass
Temperature Limit	105°C UL 125°C IEC	Wire Protector	Tin-Plated Bronze
Color	Green		

No. Poles	Cat. #	Length (B) (mm)	Std. Pk.
2	MBE-152	10.0	100
3	MBE-153	15.0	100
4	MBE-154	20.0	50
5	MBE-155	25.0	50
6	MBE-156	30.0	50
7	MBE-157	35.0	50
8	MBE-158	40.0	50
9	MBE-159	45.0	50
10	MBE-1510	50.0	50
11	MBE-1511	55.0	50
12	MBE-1512	60.0	50
13	MBE-1513	65.0	20
14	MBE-1514	70.0	20
15	MBE-1515	75.0	20
16	MBE-1516	80.0	20
17	MBE-1517	85.0	20
18	MBE-1518	90.0	20
19	MBE-1519	95.0	20
20	MBE-1520	100.0	20
21	MBE-1521	105.0	20
22	MBE-1522	110.0	20
23	MBE-1523	115.0	20
24	MBE-1524	120.0	20

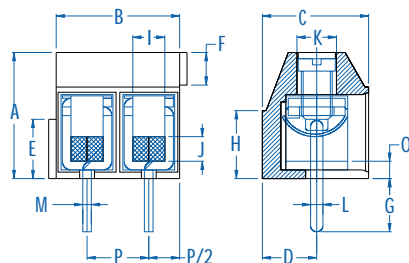

Dimensions

A	10.20 mm	I	2.60 mm
B	10.00 mm	J	2.00 mm
C	8.60 mm	K	Ø3.20 mm
D	4.40 mm	L	1.10 mm
E	4.80 mm	M	0.70 mm
F	2.70 mm	N	-
G	4.30 mm	O	1.40 mm
H	5.50 mm	P	5.00 mm

Pin Spacing: 5.00mm
 Orientation: Vertical
 Clamp Type: Box with Wire Protector
 Design: Modular



MVE-15

ELECTRICAL

	Current	Voltage	Wire Range
	10A	300V	30-16AWG
	17.5A	450V	1.5mm ² Stranded 2.5mm ² Solid

INSTALLATION DATA

Screw Size	M2.5	PCB Hole Size	1.5mm
Torque	0.4Nm (3.6 lbf-in.)	Stripping Lgth.	6.8mm

MATERIAL

Body	PA6.8	Screw	Galvanized Steel
Flammability Class	UL94V-0	Terminal	Tin-Plated Brass
Temperature Limit	105°C UL 125°C IEC	Wire Protector	Tin-Plated Bronze
Color	Green		

No. Poles	Cat. #	Length (B) (mm)	Std. Pk.
2	MVE-152	10.0	100
3	MVE-153	15.0	100
4	MVE-154	20.0	50
5	MVE-155	25.0	50
6	MVE-156	30.0	50
7	MVE-157	35.0	50
8	MVE-158	40.0	50
9	MVE-159	45.0	50
10	MVE-1510	50.0	50
11	MVE-1511	55.0	50
12	MVE-1512	60.0	50
13	MVE-1513	65.0	20
14	MVE-1514	70.0	20
15	MVE-1515	75.0	20
16	MVE-1516	80.0	20
17	MVE-1517	85.0	20
18	MVE-1518	90.0	20
19	MVE-1519	95.0	20
20	MVE-1520	100.0	20
21	MVE-1521	105.0	20
22	MVE-1522	110.0	20
23	MVE-1523	115.0	20
24	MVE-1524	120.0	20

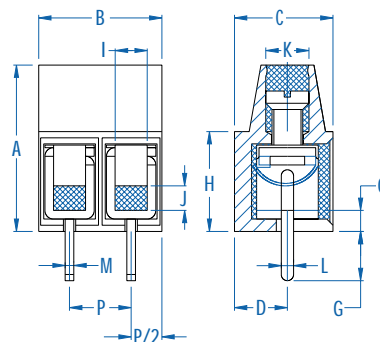

Dimensions

A	13.50 mm	I	2.60 mm
B	10.00 mm	J	2.00 mm
C	8.30 mm	K	Ø3.40 mm
D	4.30 mm	L	1.10 mm
E	-	M	0.70 mm
F	-	N	-
G	4.10 mm	O	1.70 mm
H	8.10 mm	P	5.00 mm

Fixed PCB Blocks

Pin Spacing: 5.00mm
 Orientation: Vertical
 Clamp Type: Screw Cage
 Design: Modular

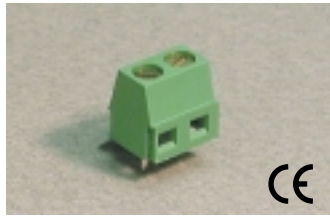

MV-15

ELECTRICAL

	Current	Voltage	Wire Range
	10A	300V	30-16AWG
	13.5A	250V	1.5mm ² Stranded 2.5mm ² Solid

INSTALLATION DATA

Screw Size	M3	PCB Hole Size	1.3mm
Torque	0.5Nm (4.5 lbf-in.)	Stripping Lgth.	6.7mm

MATERIAL

Body	PA6.8	Screw	Galvanized Steel
Flammability Class	UL94V-0	Terminal	Tin-Plated Brass
Temperature Limit	105°C UL 125°C IEC	Clamp	Nickel Brass
Color	Green		

No. Poles	Cat. #	Length (B) (mm)	Std. Pk.
2	MV-152	10.0	100
3	MV-153	15.0	100
4	MV-154	20.0	50
5	MV-155	25.0	50
6	MV-156	30.0	50
7	MV-157	35.0	50
8	MV-158	40.0	50
9	MV-159	45.0	50
10	MV-1510	50.0	50
11	MV-1511	55.0	50
12	MV-1512	60.0	50
13	MV-1513	65.0	20
14	MV-1514	70.0	20
15	MV-1515	75.0	20
16	MV-1516	80.0	20
17	MV-1517	85.0	20
18	MV-1518	90.0	20
19	MV-1519	95.0	20
20	MV-1520	100.0	20
21	MV-1521	105.0	20
22	MV-1522	110.0	20
23	MV-1523	115.0	20
24	MV-1524	120.0	20

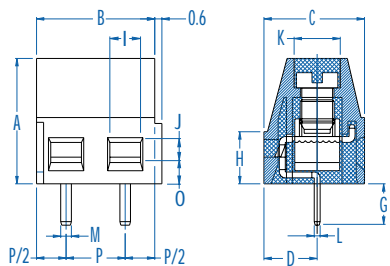

Dimensions

A	10.60 mm	I	2.60 mm
B	10.00 mm	J	1.70 mm
C	8.50 mm	K	Ø3.90 mm
D	4.50 mm	L	0.50 mm
E	-	M	0.90 mm
F	-	N	-
G	3.50 mm	O	1.80 mm
H	4.40 mm	P	5.00 mm

Pin Spacing: 5.00mm
 Orientation: Vertical
 Clamp Type: Screw Cage
 Design: Modular

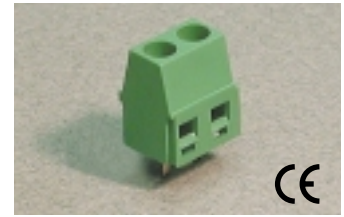

MVS-15

ELECTRICAL

	Current	Voltage	Wire Range
	10A ^①	300V	30-16AWG
	16A	250V	1.5mm ² Stranded 2.5mm ² Solid

INSTALLATION DATA

Screw Size	M3	PCB Hole Size	1.5mm
Torque	0.5Nm (4.5 lbf-in.)	Stripping Lgth.	6.9mm

MATERIAL

Body	PA6.8	Screw	Galvanized Steel
Flammability Class	UL94V-0	Terminal	Tin-Plated Brass
Temperature Limit	105°C UL 125°C IEC	Clamp	Nickel Brass
Color	Green		

No. Poles	Cat. #	Length (B) (mm)	Std. Pk.
2	MVS-152	10.0	100
3	MVS-153	15.0	100
4	MVS-154	20.0	50
5	MVS-155	25.0	50
6	MVS-156	30.0	50
7	MVS-157	35.0	50
8	MVS-158	40.0	50
9	MVS-159	45.0	50
10	MVS-1510	50.0	50
11	MVS-1511	55.0	50
12	MVS-1512	60.0	50
13	MVS-1513	65.0	20
14	MVS-1514	70.0	20
15	MVS-1515	75.0	20
16	MVS-1516	80.0	20
17	MVS-1517	85.0	20
18	MVS-1518	90.0	20
19	MVS-1519	95.0	20
20	MVS-1520	100.0	20
21	MVS-1521	105.0	20
22	MVS-1522	110.0	20
23	MVS-1523	115.0	20
24	MVS-1524	120.0	20

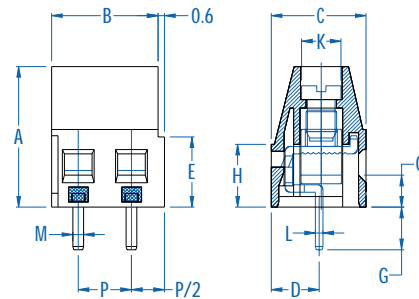

Dimensions

A	13.20 mm	I	2.60 mm
B	10.00 mm	J	2.00 mm
C	8.90 mm	K	Ø3.70 mm
D	4.50 mm	L	0.70 mm
E	6.60 mm	M	1.00 mm
F	-	N	-
G	4.00 mm	O	3.00 mm
H	5.90 mm	P	5.00 mm

① 13.5A Factory Wiring - UL

Fixed PCB Blocks

Pin Spacing: 5.00mm
 Orientation: Vertical
 Clamp Type: Screw Cage
 Design: Modular

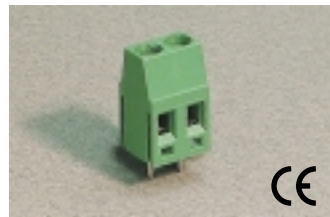

MVE-25

ELECTRICAL

	Current	Voltage	Wire Range
	15A ^①	300V	30-14AWG
	16A	450V	2.5mm ² Stranded 4.0mm ² Solid

INSTALLATION DATA

Screw Size	M3	PCB Hole Size	1.3mm
Torque	0.5Nm (4.5 lbf-in.)	Stripping Lgth.	7.1mm

MATERIAL

Body	PA6.8	Screw	Galvanized Steel
Flammability Class	UL94V-0	Terminal	Tin-Plated Brass
Temperature Limit	105°C UL 125°C IEC	Clamp	Nickel Brass
Color	Green		

No. Poles	Cat. #	Length (B) (mm)	Std. Pk.
2	MVE-252	10.0	100
3	MVE-253	15.0	100
4	MVE-254	20.0	50
5	MVE-255	25.0	50
6	MVE-256	30.0	50
7	MVE-257	35.0	50
8	MVE-258	40.0	50
9	MVE-259	45.0	50
10	MVE-2510	50.0	50
11	MVE-2511	55.0	50
12	MVE-2512	60.0	50
13	MVE-2513	65.0	20
14	MVE-2514	70.0	20
15	MVE-2515	75.0	20
16	MVE-2516	80.0	20
17	MVE-2517	85.0	20
18	MVE-2518	90.0	20
19	MVE-2519	95.0	20
20	MVE-2520	100.0	20
21	MVE-2521	105.0	20
22	MVE-2522	110.0	20
23	MVE-2523	115.0	20
24	MVE-2524	120.0	20

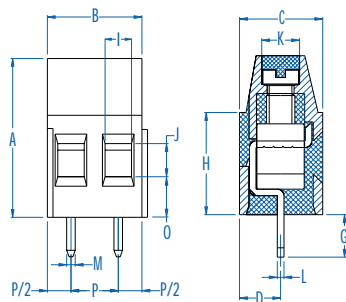

Dimensions

A	16.80 mm	I	2.80 mm
B	10.00 mm	J	2.80 mm
C	8.90 mm	K	Ø3.80 mm
D	4.35 mm	L	0.70 mm
E	-	M	0.90 mm
F	-	N	-
G	4.50 mm	O	4.60 mm
H	10.80 mm	P	5.00 mm

^① 16A Factory Wiring - UL

Pin Spacing: 5.00mm
 Orientation: Horizontal
 Clamp Type: Tubular Screw with Wire Protector
 Design: Modular



MHE-13

ELECTRICAL

	Current	Voltage	Wire Range
	16A	250V	22-16AWG

INSTALLATION DATA

Screw Size	M2.6	PCB Hole Size	1.3mm
Torque	0.4Nm (3.6 lbf-in.)	Stripping Lgth.	5.6mm

MATERIAL

Body	Glass-Filled Polyester	Screw	Galvanized Steel
Flammability Class	UL94V-0	Terminal	Tin-Plated Brass
Temperature Limit	130°C UL 125°C IEC	Wire Protector	CuSn6
Color	Black		

No. Poles	Cat. #	Length (B) (mm)	Std. Pk.
2	MHE-132	10.0	100
3	MHE-133	15.0	100
4	MHE-134	20.0	50
5	MHE-135	25.0	50
6	MHE-136	30.0	50
7	MHE-137	35.0	50
8	MHE-138	40.0	50
9	MHE-139	45.0	50
10	MHE-1310	50.0	50
11	MHE-1311	55.0	50
12	MHE-1312	60.0	50
13	MHE-1313	65.0	20
14	MHE-1314	70.0	20
15	MHE-1315	75.0	20
16	MHE-1316	80.0	20
17	MHE-1317	85.0	20
18	MHE-1318	90.0	20
19	MHE-1319	95.0	20
20	MHE-1320	100.0	20
21	MHE-1321	105.0	20
22	MHE-1322	110.0	20
23	MHE-1323	115.0	20
24	MHE-1324	120.0	20

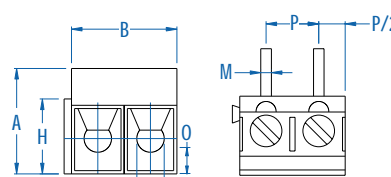

Dimensions

A	10.00 mm	I	-
B	10.00 mm	J	Ø2.60 mm
C	7.50 mm	K	Ø3.50 mm
D	2.70 mm	L	-
E	-	M	Ø1.00 mm
F	-	N	-
G	3.70 mm	O	1.40 mm
H	7.10 mm	P	5.00 mm

Fixed PCB Blocks

Pin Spacing: 5.00mm
 Orientation: Horizontal
 Clamp Type: Tubular Screw with Wire Protector
 Design: Modular

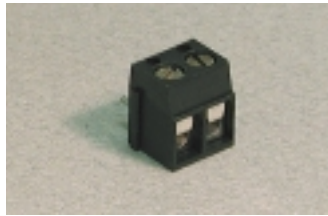

MHE-16

ELECTRICAL

	Current	Voltage	Wire Range
	16A	250V	22-14AWG

INSTALLATION DATA

Screw Size	M3	PCB Hole Size	1.3mm
Torque	0.5Nm (4.5 lbf-in.)	Stripping Lgth.	5.8mm

MATERIAL

Body	Glass-Filled Polyester	Screw	Galvanized Steel
Flammability Class	UL94V-0	Terminal	Tin-Plated Brass
Temperature Limit	130°C UL 125°C IEC	Wire Protector	CuSn6
Color	Black		

No. Poles	Cat. #	Length (B) (mm)	Std. Pk.
2	MHE-162	10.0	100
3	MHE-163	15.0	100
4	MHE-164	20.0	50
5	MHE-165	25.0	50
6	MHE-166	30.0	50
7	MHE-167	35.0	50
8	MHE-168	40.0	50
9	MHE-169	45.0	50
10	MHE-1610	50.0	50
11	MHE-1611	55.0	50
12	MHE-1612	60.0	50
13	MHE-1613	65.0	20
14	MHE-1614	70.0	20
15	MHE-1615	75.0	20
16	MHE-1616	80.0	20
17	MHE-1617	85.0	20
18	MHE-1618	90.0	20
19	MHE-1619	95.0	20
20	MHE-1620	100.0	20
21	MHE-1621	105.0	20
22	MHE-1622	110.0	20
23	MHE-1623	115.0	20
24	MHE-1624	120.0	20

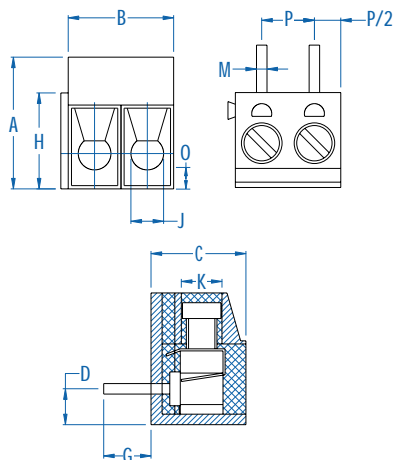

Dimensions

A	12.50 mm	I	-
B	10.00 mm	J	Ø3.10 mm
C	9.00 mm	K	Ø3.95 mm
D	3.40 mm	L	-
E	-	M	Ø1.00 mm
F	-	N	-
G	4.50 mm	O	2.00 mm
H	8.80 mm	P	5.00 mm

Pin Spacing: 5.00mm
 Orientation: Horizontal
 Clamp Type: Screw Cage
 Design: Modular



MH-15

ELECTRICAL

	Current	Voltage	Wire Range
	10A	300V	30-16AWG
	13.5A	250V	1.5mm² Stranded 2.5mm² Solid

INSTALLATION DATA

Screw Size	M3	PCB Hole Size	1.3mm
Torque	0.5Nm (4.5 lbf-in.)	Stripping Lgth.	6.7mm

MATERIAL

Body	PA6.8	Screw	Galvanized Steel
Flammability Class	UL94V-0	Terminal	Tin-Plated Brass
Temperature Limit	105°C UL 125°C IEC	Clamp	Nickel Brass
Color	Green		

No. Poles	Cat. #	Length (B) (mm)	Std. Pk.
2	MH-152	10.0	100
3	MH-153	15.0	100
4	MH-154	20.0	50
5	MH-155	25.0	50
6	MH-156	30.0	50
7	MH-157	35.0	50
8	MH-158	40.0	50
9	MH-159	45.0	50
10	MH-1510	50.0	50
11	MH-1511	55.0	50
12	MH-1512	60.0	50
13	MH-1513	65.0	20
14	MH-1514	70.0	20
15	MH-1515	75.0	20
16	MH-1516	80.0	20
17	MH-1517	85.0	20
18	MH-1518	90.0	20
19	MH-1519	95.0	20
20	MH-1520	100.0	20
21	MH-1521	105.0	20
22	MH-1522	110.0	20
23	MH-1523	115.0	20
24	MH-1524	120.0	20

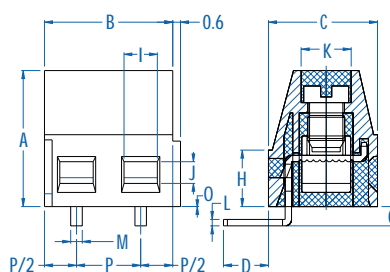

Dimensions

A	10.60 mm	I	2.60 mm
B	10.00 mm	J	1.70 mm
C	8.50 mm	K	Ø3.90 mm
D	3.70 mm	L	0.50 mm
E	-	M	0.90 mm
F	-	N	-
G	1.50 mm	O	1.80 mm
H	4.40 mm	P	5.00 mm

Fixed PCB Blocks

Pin Spacing: 5.00mm
 Orientation: Horizontal
 Clamp Type: Screw Cage
 Design: Modular

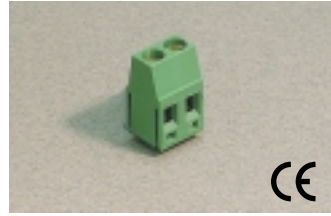

MHE-25

ELECTRICAL

	Current	Voltage	Wire Range
	15A ^①	300V	30-14AWG
	16A	450V	2.5mm ² Stranded 4.0mm ² Solid

INSTALLATION DATA

Screw Size	M3	PCB Hole Size	1.3mm
Torque	0.5Nm (4.5 lbf-in.)	Stripping Lgth.	7.1mm

MATERIAL

Body	PA6.8	Screw	Galvanized Steel
Flammability Class	UL94V-0	Terminal	Tin-Plated Brass
Temperature Limit	105°C UL 125°C IEC	Clamp	Nickeled Brass
Color	Green		

No. Poles	Cat. #	Length (B) (mm)	Std. Pk.
2	MHE-252	10.0	100
3	MHE-253	15.0	100
4	MHE-254	20.0	50
5	MHE-255	25.0	50
6	MHE-256	30.0	50
7	MHE-257	35.0	50
8	MHE-258	40.0	50
9	MHE-259	45.0	50
10	MHE-2510	50.0	50
11	MHE-2511	55.0	50
12	MHE-2512	60.0	50
13	MHE-2513	65.0	20
14	MHE-2514	70.0	20
15	MHE-2515	75.0	20
16	MHE-2516	80.0	20
17	MHE-2517	85.0	20
18	MHE-2518	90.0	20
19	MHE-2519	95.0	20
20	MHE-2520	100.0	20
21	MHE-2521	105.0	20
22	MHE-2522	110.0	20
23	MHE-2523	115.0	20
24	MHE-2524	120.0	20

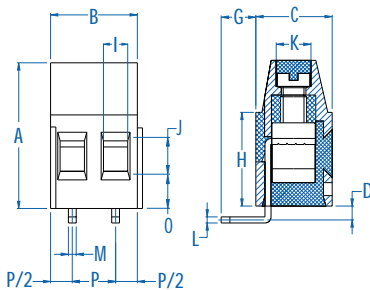

Dimensions

A	16.80 mm	I	2.80 mm
B	10.00 mm	J	2.80 mm
C	8.90 mm	K	Ø3.80 mm
D	1.40 mm	L	0.70 mm
E	-	M	0.90 mm
F	-	N	-
G	4.00 mm	O	4.60 mm
H	10.80 mm	P	5.00 mm

① 16A Factory Wiring - UL

Pin Spacing: 5.00mm
 Orientation: Reverse Horizontal
 Clamp Type: Screw Cage
 Design: Modular

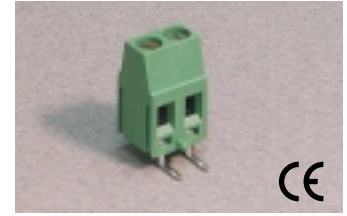

MHR-25

ELECTRICAL

	Current	Voltage	Wire Range
	15A ^①	300V	30-14AWG
	16A	250V	2.5mm ² Stranded 4.0mm ² Solid

INSTALLATION DATA

Screw Size	M3	PCB Hole Size	1.3mm
Torque	0.5Nm (4.5 lbf-in.)	Stripping Lgth.	7.1mm

MATERIAL

Body	PA6.8	Screw	Galvanized Steel
Flammability Class	UL94V-0	Terminal	Tin-Plated Brass
Temperature Limit	105°C UL 125°C IEC	Clamp	Nickeled Brass
Color	Green		

No. Poles	Cat. #	Length (B) (mm)	Std. Pk.
2	MHR-252	10.0	100
3	MHR-253	15.0	100
4	MHR-254	20.0	50
5	MHR-255	25.0	50
6	MHR-256	30.0	50
7	MHR-257	35.0	50
8	MHR-258	40.0	50
9	MHR-259	45.0	50
10	MHR-2510	50.0	50
11	MHR-2511	55.0	50
12	MHR-2512	60.0	50
13	MHR-2513	65.0	20
14	MHR-2514	70.0	20
15	MHR-2515	75.0	20
16	MHR-2516	80.0	20
17	MHR-2517	85.0	20
18	MHR-2518	90.0	20
19	MHR-2519	95.0	20
20	MHR-2520	100.0	20
21	MHR-2521	105.0	20
22	MHR-2522	110.0	20
23	MHR-2523	115.0	20
24	MHR-2524	120.0	20

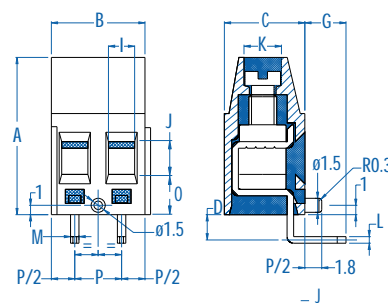

Dimensions

A	16.80 mm	I	2.80 mm
B	10.00 mm	J	2.80 mm
C	8.90 mm	K	Ø3.80 mm
D	2.30 mm	L	0.70 mm
E	-	M	0.90 mm
F	-	N	-
G	4.00 mm	O	4.60 mm
H	-	P	5.00 mm

① 16A Factory Wiring - UL

Fixed PCB Blocks

Pin Spacing: 5.00mm
 Orientation: 45°
 Clamp Type: Screw Cage
 Design: Modular

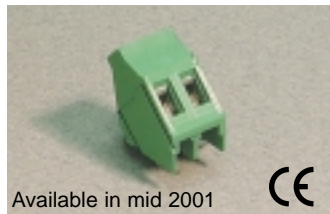

Available in mid 2001

MI-25(5.00)

ELECTRICAL

	Current	Voltage	Wire Range
	15A ^①	300V	30-14AWG
	16A	450V	2.5mm ² Stranded 4.0mm ² Solid

INSTALLATION DATA

Screw Size	M3	PCB Hole Size	1.3mm
Torque	0.5Nm (4.5 lbf-in.)	Stripping Lgth.	8.3mm

MATERIAL

Body	PA6.8	Screw	Galvanized Steel
Flammability Class	UL94V-0	Terminal	Tin-Plated Brass
Temperature Limit	105°C UL 125°C IEC	Clamp	Nickel Brass
Color	Green		

No. Poles	Cat. #	Length (B) (mm)	Std. Pk.
2	MI-252 (5.00)	10.0	100
3	MI-253 (5.00)	15.0	100
4	MI-254 (5.00)	20.0	50
5	MI-255 (5.00)	25.0	50
6	MI-256 (5.00)	30.0	50
7	MI-257 (5.00)	35.0	50
8	MI-258 (5.00)	40.0	50
9	MI-259 (5.00)	45.0	50
10	MI-2510 (5.00)	50.0	50
11	MI-2511 (5.00)	55.0	50
12	MI-2512 (5.00)	60.0	50
13	MI-2513 (5.00)	65.0	20
14	MI-2514 (5.00)	70.0	20
15	MI-2515 (5.00)	75.0	20
16	MI-2516 (5.00)	80.0	20
17	MI-2517 (5.00)	85.0	20
18	MI-2518 (5.00)	90.0	20
19	MI-2519 (5.00)	95.0	20
20	MI-2520 (5.00)	100.0	20
21	MI-2521 (5.00)	105.0	20
22	MI-2522 (5.00)	110.0	20
23	MI-2523 (5.00)	115.0	20
24	MI-2524 (5.00)	120.0	20

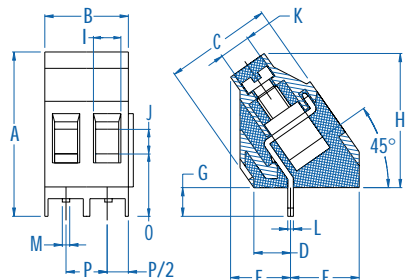

Dimensions

A	21.10 mm	I	2.80 mm
B	10.00 mm	J	2.80 mm
C	13.00 mm	K	Ø3.80 mm
D	4.95 mm	L	0.70 mm
E	7.00 mm	M	0.90 mm
F	10.10 mm	N	-
G	4.00 mm	O	8.50 mm
H	16.30 mm	P	5.00 mm

① 16A Factory Wiring - UL

Pin Spacing: 5.08mm
 Orientation: Vertical
 Clamp Type: Box with Wire Protector
 Design: Modular

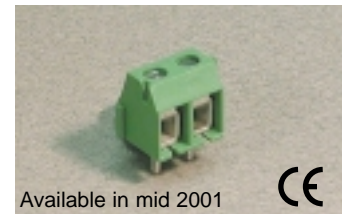

Available in mid 2001

MBES-15

ELECTRICAL

	Current	Voltage	Wire Range
	10A ^①	300V	30-16AWG
	17.5A	250V	1.5mm ² Stranded 2.5mm ² Solid

INSTALLATION DATA

Screw Size	M2.5	PCB Hole Size	1.5mm
Torque	0.4Nm (3.6 lbf-in.)	Stripping Lgth.	6.7mm

MATERIAL

Body	PA6.8	Screw	Galvanized Steel
Flammability Class	UL94V-0	Terminal	Tin-Plated Brass
Temperature Limit	105°C UL 125°C IEC	Wire Protector	Tin-Plated Bronze
Color	Green		

No. Poles	Cat. #	Length (B) (mm)	Std. Pk.
2	MBES-152	10.2	100
3	MBES-153	15.2	100
4	MBES-154	20.3	50
5	MBES-155	25.4	50
6	MBES-156	30.5	50
7	MBES-157	35.6	50
8	MBES-158	40.6	50
9	MBES-159	45.7	50
10	MBES-1510	50.8	50
11	MBES-1511	55.9	50
12	MBES-1512	61.0	50
13	MBES-1513	66.0	20
14	MBES-1514	71.1	20
15	MBES-1515	76.2	20
16	MBES-1516	81.3	20
17	MBES-1517	86.4	20
18	MBES-1518	91.4	20
19	MBES-1519	96.5	20
20	MBES-1520	101.6	20
21	MBES-1521	106.7	20
22	MBES-1522	111.8	20
23	MBES-1523	116.8	20
24	MBES-1524	121.9	20

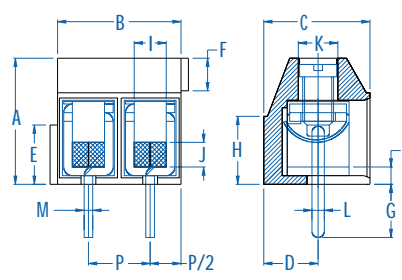

Dimensions

A	10.20 mm	I	2.60 mm
B	10.16 mm	J	2.00 mm
C	7.60 mm	K	Ø3.00 mm
D	3.80 mm	L	1.10 mm
E	4.70 mm	M	0.70 mm
F	2.80 mm	N	-
G	4.30 mm	O	1.40 mm
H	5.30 mm	P	5.08 mm

① 17.5A Factory Wiring - UL

Fixed PCB Blocks

Pin Spacing: 5.08mm
 Orientation: Vertical
 Clamp Type: Screw Cage
 Design: Modular

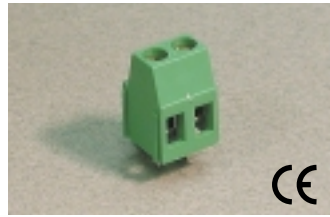

MV-25

ELECTRICAL

	Current	Voltage	Wire Range
	15A ^①	300V	30-14AWG
	16A	450V	2.5mm ² Stranded 4.0mm ² Solid

INSTALLATION DATA

Screw Size	M3	PCB Hole Size	1.3mm
Torque	0.5Nm (4.5 lbf-in.)	Stripping Lgth.	8.3mm

MATERIAL

Body	PA6.8	Screw	Galvanized Steel
Flammability Class	UL94V-0	Terminal	Tin-Plated Brass
Temperature Limit	105°C UL 125°C IEC	Clamp	Nickeled Brass
Color	Green		

No. Poles	Cat. #	Length (B) (mm)	Std. Pk.
2	MV-252	10.2	100
3	MV-253	15.2	100
4	MV-254	20.3	50
5	MV-255	25.4	50
6	MV-256	30.5	50
7	MV-257	35.6	50
8	MV-258	40.6	50
9	MV-259	45.7	50
10	MV-2510	50.8	50
11	MV-2511	55.9	50
12	MV-2512	61.0	50
13	MV-2513	66.0	20
14	MV-2514	71.1	20
15	MV-2515	76.2	20
16	MV-2516	81.3	20
17	MV-2517	86.4	20
18	MV-2518	91.4	20
19	MV-2519	96.5	20
20	MV-2520	101.6	20
21	MV-2521	106.7	20
22	MV-2522	111.8	20
23	MV-2523	116.8	20
24	MV-2524	121.9	20

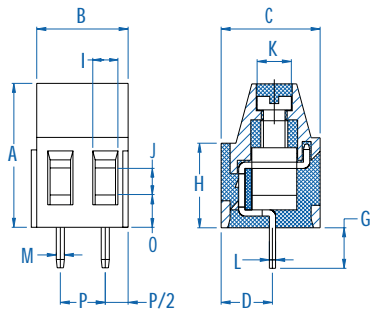

Dimensions

A	16.00 mm	I	2.80 mm
B	10.16 mm	J	2.80 mm
C	11.00 mm	K	Ø3.80 mm
D	5.00 mm	L	0.70 mm
E	-	M	0.90 mm
F	-	N	-
G	4.50 mm	O	3.60 mm
H	9.40 mm	P	5.08 mm

^① 16A Factory Wiring - UL

Pin Spacing: 5.08mm
 Orientation: Vertical
 Clamp Type: Screw Cage
 Design: Modular

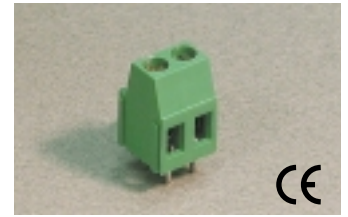

MV-25-D

ELECTRICAL

	Current	Voltage	Wire Range
	15A ^①	300V	30-14AWG
	24A	450V	2.5mm ² Stranded 4.0mm ² Solid

INSTALLATION DATA

Screw Size	M3	PCB Hole Size	1.3mm
Torque	0.5Nm (4.5 lbf-in.)	Stripping Lgth.	8.3mm

MATERIAL

Body	PA6.8	Screw	Galvanized Steel
Flammability Class	UL94V-0	Terminal	Tin-Plated Brass
Temperature Limit	105°C UL 125°C IEC	Clamp	Nickeled Brass
Color	Green		

No. Poles	Cat. #	Length (B) (mm)	Std. Pk.
2	MV-252-D	10.2	100
3	MV-253-D	15.2	100
4	MV-254-D	20.3	50
5	MV-255-D	25.4	50
6	MV-256-D	30.5	50
7	MV-257-D	35.6	50
8	MV-258-D	40.6	50
9	MV-259-D	45.7	50
10	MV-2510-D	50.8	50
11	MV-2511-D	55.9	50
12	MV-2512-D	61.0	50
13	MV-2513-D	66.0	20
14	MV-2514-D	71.1	20
15	MV-2515-D	76.2	20
16	MV-2516-D	81.3	20
17	MV-2517-D	86.4	20
18	MV-2518-D	91.4	20
19	MV-2519-D	96.5	20
20	MV-2520-D	101.6	20
21	MV-2521-D	106.7	20
22	MV-2522-D	111.8	20
23	MV-2523-D	116.8	20
24	MV-2524-D	121.9	20

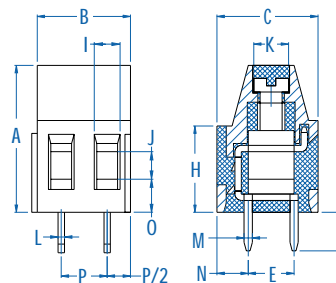

Dimensions

A	16.00 mm	I	2.80 mm
B	10.16 mm	J	2.80 mm
C	11.00 mm	K	Ø3.80 mm
D	-	L	0.70 mm
E	5.00 mm	M	0.90 mm
F	-	N	3.40 mm
G	4.50 mm	O	3.60 mm
H	9.40 mm	P	5.08 mm

^① 18A Factory Wiring - UL

Fixed PCB Blocks

Pin Spacing: 5.08mm*
 Orientation: Vertical
 Clamp Type: Screw Cage
 Design: Modular

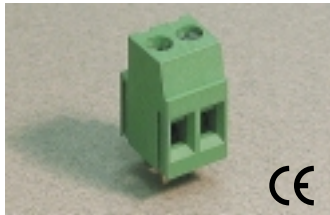

MVSP-25

ELECTRICAL

	Current	Voltage	Wire Range
	15A ^①	300V	30-14AWG
	24A	450V	2.5mm ² Stranded 4.0mm ² Solid

INSTALLATION DATA

Screw Size	M3	PCB Hole Size	1.5mm
Torque	0.5Nm (4.5 lbf-in.)	Stripping Lgth.	9.5mm

MATERIAL

Body	PA6.8	Screw	Galvanized Steel
Flammability Class	UL94V-0	Terminal	Tin-Plated Brass
Temperature Limit	105°C UL 125°C IEC	Clamp	Nickel Brass
Color	Green		

No. Poles	Cat. #	Length (B) (mm)	Std. Pk.
2	MVSP-252	10.2	100
3	MVSP-253	15.2	100
4	MVSP-254	20.3	50
5	MVSP-255	25.4	50
6	MVSP-256	30.5	50
7	MVSP-257	35.6	50
8	MVSP-258	40.6	50
9	MVSP-259	45.7	50
10	MVSP-2510	50.8	50
11	MVSP-2511	55.9	50
12	MVSP-2512	61.0	50
13	MVSP-2513	66.0	20
14	MVSP-2514	71.1	20
15	MVSP-2515	76.2	20
16	MVSP-2516	81.3	20
17	MVSP-2517	86.4	20
18	MVSP-2518	91.4	20
19	MVSP-2519	96.5	20
20	MVSP-2520	101.6	20
21	MVSP-2521	106.7	20
22	MVSP-2522	111.8	20
23	MVSP-2523	116.8	20
24	MVSP-2524	121.9	20

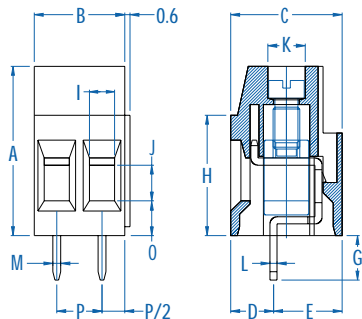

Dimensions

A	19.00 mm	I	2.80 mm
B	10.16 mm	J	4.00 mm
C	12.50 mm	K	Ø4.00 mm
D	4.80 mm	L	0.80 mm
E	7.70 mm	M	1.00 mm
F	-	N	-
G	5.00 mm	O	3.90 mm
H	13.50 mm	P	5.08 mm

* Also available in 10.16mm pin spacing.

^① 18A Factory Wiring - UL

Pin Spacing: 5.08mm
 Orientation: Horizontal
 Clamp Type: Screw Cage
 Design: Modular

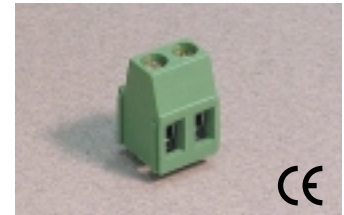

MH-25

ELECTRICAL

	Current	Voltage	Wire Range
	15A ^①	300V	30-14AWG
	16A	450V	2.5mm ² Stranded 4.0mm ² Solid

INSTALLATION DATA

Screw Size	M3	PCB Hole Size	1.3mm
Torque	0.5Nm (4.5 lbf-in.)	Stripping Lgth.	8.3mm

MATERIAL

Body	PA6.8	Screw	Galvanized Steel
Flammability Class	UL94V-0	Terminal	Tin-Plated Brass
Temperature Limit	105°C UL 125°C IEC	Clamp	Nickel Brass
Color	Green		

No. Poles	Cat. #	Length (B) (mm)	Std. Pk.
2	MH-252	10.2	100
3	MH-253	15.2	100
4	MH-254	20.3	50
5	MH-255	25.4	50
6	MH-256	30.5	50
7	MH-257	35.6	50
8	MH-258	40.6	50
9	MH-259	45.7	50
10	MH-2510	50.8	50
11	MH-2511	55.9	50
12	MH-2512	61.0	50
13	MH-2513	66.0	20
14	MH-2514	71.1	20
15	MH-2515	76.2	20
16	MH-2516	81.3	20
17	MH-2517	86.4	20
18	MH-2518	91.4	20
19	MH-2519	96.5	20
20	MH-2520	101.6	20
21	MH-2521	106.7	20
22	MH-2522	111.8	20
23	MH-2523	116.8	20
24	MH-2524	121.9	20

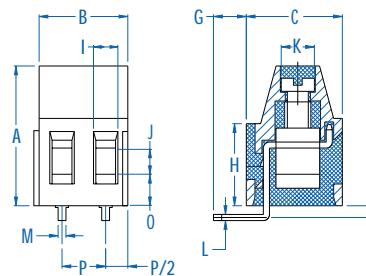

Dimensions

A	16.00 mm	I	2.80 mm
B	10.16 mm	J	2.80 mm
C	11.00 mm	K	Ø3.80 mm
D	2.00 mm	L	0.70 mm
E	-	M	0.90 mm
F	-	N	-
G	3.60 mm	O	3.60 mm
H	9.40 mm	P	5.08 mm

^① 16A Factory Wiring - UL

Fixed PCB Blocks

Pin Spacing: 5.08mm*
 Orientation: Horizontal
 Clamp Type: Screw Cage
 Design: Modular

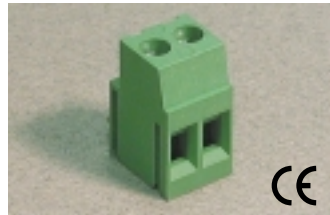

MHSP-25

ELECTRICAL

	Current	Voltage	Wire Range
US Pending	15A ^①	300V	30-14AWG
	24A	450V	2.5mm ² Stranded 4.0mm ² Solid

INSTALLATION DATA

Screw Size	M3	PCB Hole Size	1.5mm
Torque	0.5Nm (4.5 lbf-in.)	Stripping Lgth.	9.5mm

MATERIAL

Body	PA6.8	Screw	Galvanized Steel
Flammability Class	UL94V-0	Terminal	Tin-Plated Brass
Temperature Limit	105°C UL 125°C IEC	Clamp	Nickeled Brass
Color	Green		

No. Poles	Cat. #	Length (B) (mm)	Std. Pk.
2	MHSP-252	10.2	100
3	MHSP-253	15.2	100
4	MHSP-254	20.3	50
5	MHSP-255	25.4	50
6	MHSP-256	30.5	50
7	MHSP-257	35.6	50
8	MHSP-258	40.6	50
9	MHSP-259	45.7	50
10	MHSP-2510	50.8	50
11	MHSP-2511	55.9	50
12	MHSP-2512	61.0	50
13	MHSP-2513	66.0	20
14	MHSP-2514	71.1	20
15	MHSP-2515	76.2	20
16	MHSP-2516	81.3	20
17	MHSP-2517	86.4	20
18	MHSP-2518	91.4	20
19	MHSP-2519	96.5	20
20	MHSP-2520	101.6	20
21	MHSP-2521	106.7	20
22	MHSP-2522	111.8	20
23	MHSP-2523	116.8	20
24	MHSP-2524	121.9	20

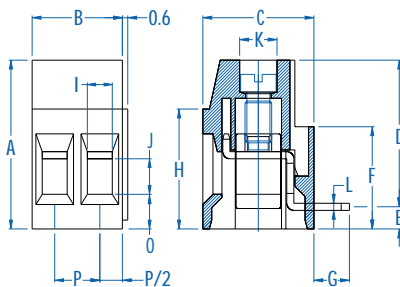

Dimensions

A	19.00 mm	I	2.80 mm
B	10.16 mm	J	4.00 mm
C	12.50 mm	K	Ø4.00 mm
D	16.50 mm	L	0.80 mm
E	2.50 mm	M	1.00 mm
F	11.50 mm	N	-
G	4.00 mm	O	3.90 mm
H	13.50 mm	P	5.08 mm

* Also available in 10.16mm pin spacing.

① 18A Factory Wiring - UL

Pin Spacing: 5.08mm
 Orientation: 35°
 Clamp Type: Screw Cage
 Design: Modular



MI-25 (35)

ELECTRICAL

	Current	Voltage	Wire Range
US	15A ^①	300V	30-14AWG
	16A	450V	2.5mm ² Stranded 4.0mm ² Solid

INSTALLATION DATA

Screw Size	M3	PCB Hole Size	1.3mm
Torque	0.5Nm (4.5 lbf-in.)	Stripping Lgth.	8.3mm

MATERIAL

Body	PA6.8	Screw	Galvanized Steel
Flammability Class	UL94V-0	Terminal	Tin-Plated Brass
Temperature Limit	105°C UL 125°C IEC	Clamp	Nickeled Brass
Color	Green		

No. Poles	Cat. #	Length (B) (mm)	Std. Pk.
2	MI-252 (35)	10.2	100
3	MI-253 (35)	15.2	100
4	MI-254 (35)	20.3	50
5	MI-255 (35)	25.4	50
6	MI-256 (35)	30.5	50
7	MI-257 (35)	35.6	50
8	MI-258 (35)	40.6	50
9	MI-259 (35)	45.7	50
10	MI-2510 (35)	50.8	50
11	MI-2511 (35)	55.9	50
12	MI-2512 (35)	61.0	50
13	MI-2513 (35)	66.0	20
14	MI-2514 (35)	71.1	20
15	MI-2515 (35)	76.2	20
16	MI-2516 (35)	81.3	20
17	MI-2517 (35)	86.4	20
18	MI-2518 (35)	91.4	20
19	MI-2519 (35)	96.5	20
20	MI-2520 (35)	101.6	20
21	MI-2521 (35)	106.7	20
22	MI-2522 (35)	111.8	20
23	MI-2523 (35)	116.8	20
24	MI-2524 (35)	121.9	20

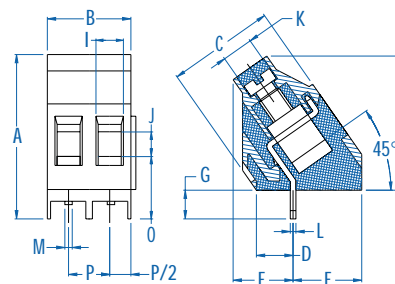

Dimensions

A	20.00 mm	I	2.80 mm
B	10.16 mm	J	2.80 mm
C	13.00 mm	K	Ø3.80 mm
D	4.50 mm	L	0.70 mm
E	7.70 mm	M	0.90 mm
F	7.30 mm	N	-
G	4.00 mm	O	6.75 mm
H	16.30 mm	P	5.08 mm

① 16A Factory Wiring - UL

Fixed PCB Blocks

Pin Spacing: 5.08mm
 Orientation: 45°
 Clamp Type: Screw Cage
 Design: Modular

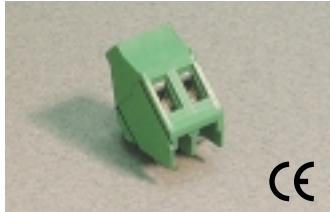

MI-25 (45)

ELECTRICAL

	Current	Voltage	Wire Range
	15A ^①	300V	30-14AWG
	16A	450V	2.5mm ² Stranded 4.0mm ² Solid

INSTALLATION DATA

Screw Size	M3	PCB Hole Size	1.3mm
Torque	0.5Nm (4.5 lbf-in.)	Stripping Lgth.	8.3mm

MATERIAL

Body	PA6.8	Screw	Galvanized Steel
Flammability Class	UL94V-0	Terminal	Tin-Plated Brass
Temperature Limit	105°C UL 125°C IEC	Clamp	Nickeled Brass
Color	Green		

No. Poles	Cat. #	Length (B) (mm)	Std. Pk.
2	MI-252 (45)	10.2	100
3	MI-253 (45)	15.2	100
4	MI-254 (45)	20.3	50
5	MI-255 (45)	25.4	50
6	MI-256 (45)	30.5	50
7	MI-257 (45)	35.6	50
8	MI-258 (45)	40.6	50
9	MI-259 (45)	45.7	50
10	MI-2510 (45)	50.8	50
11	MI-2511 (45)	55.9	50
12	MI-2512 (45)	61.0	50
13	MI-2513 (45)	66.0	20
14	MI-2514 (45)	71.1	20
15	MI-2515 (45)	76.2	20
16	MI-2516 (45)	81.3	20
17	MI-2517 (45)	86.4	20
18	MI-2518 (45)	91.4	20
19	MI-2519 (45)	96.5	20
20	MI-2520 (45)	101.6	20
21	MI-2521 (45)	106.7	20
22	MI-2522 (45)	111.8	20
23	MI-2523 (45)	116.8	20
24	MI-2524 (45)	121.9	20

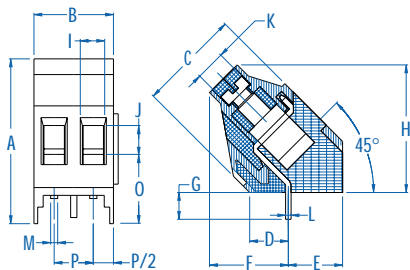

Dimensions

A	21.00 mm	I	2.80 mm
B	10.16 mm	J	2.80 mm
C	13.00 mm	K	Ø3.80 mm
D	4.50 mm	L	0.70 mm
E	7.70 mm	M	0.90 mm
F	10.00 mm	N	-
G	4.00 mm	O	8.60 mm
H	16.30 mm	P	5.08 mm

^① 16A Factory Wiring - UL

Pin Spacing: 5.08mm
 Orientation: Vertical-Double Level
 Clamp Type: Screw Cage
 Design: Modular-Offset

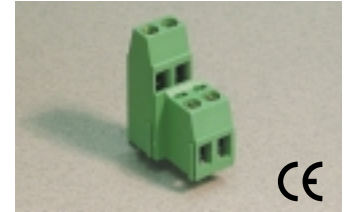

MVD-25

ELECTRICAL

	Current	Voltage	Wire Range
	15A ^①	300V	30-14AWG
	16A	450V	2.5mm ² Stranded 4.0mm ² Solid

INSTALLATION DATA

Screw Size	M3	PCB Hole Size	1.3mm
Torque	0.5Nm (4.5 lbf-in.)	Stripping Lgth.	8.3mm

MATERIAL

Body	PA6.8	Screw	Galvanized Steel
Flammability Class	UL94V-0	Terminal	Tin-Plated Brass
Temperature Limit	105°C UL 125°C IEC	Clamp	Nickeled Brass
Color	Green		

No. Poles	Cat. #	Length (B) (mm)	Std. Pk.
4	MVD-252	12.7	100
6	MVD-253	17.8	100
8	MVD-254	22.9	50
10	MVD-255	27.9	50
12	MVD-256	33.0	50
14	MVD-257	38.1	50
16	MVD-258	43.2	50
18	MVD-259	48.3	50
20	MVD-2510	53.3	50
22	MVD-2511	58.4	20
24	MVD-2512	63.5	20
26	MVD-2513	68.6	20
28	MVD-2514	73.7	20
30	MVD-2515	78.7	20
32	MVD-2516	83.2	20
34	MVD-2517	88.9	20
36	MVD-2518	94.0	20
38	MVD-2519	99.1	20
40	MVD-2520	104.1	10
42	MVD-2521	109.2	10
44	MVD-2522	114.3	10
46	MVD-2523	119.4	10
48	MVD-2524	124.5	10
50	MVD-2525	129.5	10

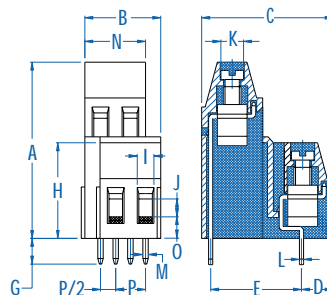

Dimensions

A	29.50 mm	I	2.80 mm
B	12.70 mm	J	2.80 mm
C	22.00 mm	K	Ø3.80 mm
D	5.30 mm	L	0.70 mm
E	15.24 mm	M	0.90 mm
F	-	N	10.16 mm
G	4.70 mm	O	3.60 mm
H	16.00 mm	P	5.08 mm

^① 16A Factory Wiring - UL

Fixed PCB Blocks



Pin Spacing: 5.08mm
 Orientation: Vertical-Double Level
 Clamp Type: Screw Cage
 Design: Modular-Aligned

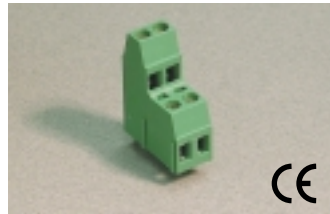

MVDK-25

ELECTRICAL

	Current	Voltage	Wire Range
	15A ^①	300V	30-14AWG
	16A	450V	2.5mm ² Stranded 4.0mm ² Solid

INSTALLATION DATA

Screw Size	M3	PCB Hole Size	1.3mm
Torque	0.5Nm (4.5 lbf-in.)	Stripping Lgth.	8.3mm

MATERIAL

Body	PA6.8	Screw	Galvanized Steel
Flammability Class	UL94V-0	Terminal	Tin-Plated Brass
Temperature Limit	105°C UL 125°C IEC	Clamp	Nickel Brass
Color	Green		

No. Poles	Cat. #	Length (B) (mm)	Std. Pk.
4	MVDK-252	10.2	100
6	MVDK-253	15.2	100
8	MVDK-254	20.3	50
10	MVDK-255	25.4	50
12	MVDK-256	30.5	50
14	MVDK-257	35.6	50
16	MVDK-258	40.6	50
18	MVDK-259	45.7	50
20	MVDK-2510	50.8	50
22	MVDK-2511	55.9	20
24	MVDK-2512	61.0	20
26	MVDK-2513	66.0	20
28	MVDK-2514	71.1	20
30	MVDK-2515	76.2	20
32	MVDK-2516	81.3	20
34	MVDK-2517	86.4	20
36	MVDK-2518	91.4	20
38	MVDK-2519	96.5	20
40	MVDK-2520	101.6	10
42	MVDK-2521	106.7	10
44	MVDK-2522	111.8	10
46	MVDK-2523	116.8	10
48	MVDK-2524	121.9	10
50	MVDK-2525	129.5	10

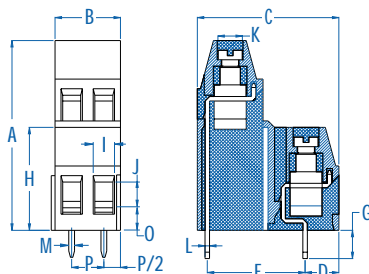

Dimensions

A	29.50 mm	I	2.80 mm
B	10.16 mm	J	2.80 mm
C	22.00 mm	K	Ø3.80 mm
D	5.30 mm	L	0.70 mm
E	15.24 mm	M	0.90 mm
F	-	N	-
G	4.70 mm	O	3.60 mm
H	16.00 mm	P	5.08 mm

^① 16A Factory Wiring - UL

Pin Spacing: 5.08mm
 Orientation: Vertical-Triple Level
 Clamp Type: Screw Cage
 Design: Modular

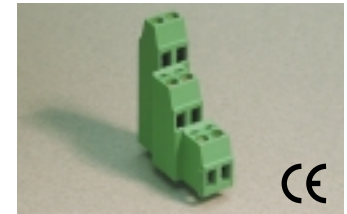

MVT-25

ELECTRICAL

	Current	Voltage	Wire Range
	15A ^①	300V	30-14AWG
	16A	450V	2.5mm ² Stranded 4.0mm ² Solid

INSTALLATION DATA

Screw Size	M3	PCB Hole Size	1.3mm
Torque	0.5Nm (4.5 lbf-in.)	Stripping Lgth.	8.3mm

MATERIAL

Body	PA6.8	Screw	Galvanized Steel
Flammability Class	UL94V-0	Terminal	Tin-Plated Brass
Temperature Limit	105°C UL 125°C IEC	Clamp	Nickel Brass
Color	Green		

No. Poles	Cat. #	Length (B) (mm)	Std. Pk.
6	MVT-252	12.7	50
9	MVT-253	17.8	50
12	MVT-254	22.9	30
15	MVT-255	27.9	30
18	MVT-256	33.0	30
21	MVT-257	38.1	30
24	MVT-258	43.2	30
27	MVT-259	48.3	30
30	MVT-2510	53.3	30
33	MVT-2511	58.4	15
36	MVT-2512	63.5	15
39	MVT-2513	68.6	15
42	MVT-2514	73.7	15
45	MVT-2515	78.7	15
48	MVT-2516	83.2	15
51	MVT-2517	88.9	15
54	MVT-2518	94.0	15
57	MVT-2519	99.1	15
60	MVT-2520	104.1	5
63	MVT-2521	109.2	5
66	MVT-2522	114.3	5
69	MVT-2523	119.4	5
72	MVT-2524	124.5	5

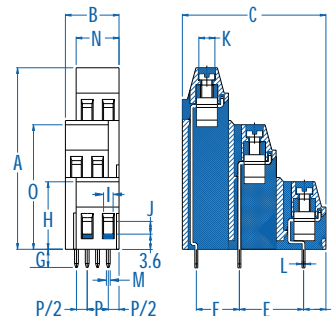

Dimensions

A	43.00 mm	I	2.80 mm
B	12.70 mm	J	2.80 mm
C	34.00 mm	K	Ø3.80 mm
D	5.30 mm	L	0.70 mm
E	15.24 mm	M	0.90 mm
F	10.16 mm	N	10.16 mm
G	4.50 mm	O	29.50 mm
H	16.00 mm	P	5.08 mm

^① 16A Factory Wiring - UL

Fixed PCB Blocks

Pin Spacing: 6.35mm/ 12.7mm*
 Orientation: Vertical
 Clamp Type: Screw Cage
 Design: Modular

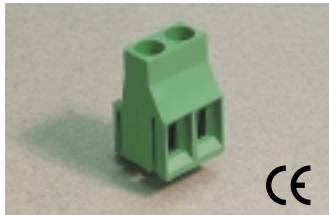

MV-46

ELECTRICAL

	Current	Voltage	Wire Range
	20A ^①	300V	30-12AWG
	25A	500V	4.0mm ² Stranded 6.0mm ² Solid

INSTALLATION DATA

Screw Size	M3	PCB Hole Size	1.3mm
Torque	0.5Nm (4.5 lbf-in.)	Stripping Lgth.	9.8mm

MATERIAL

Body	PA6.8	Screw	Galvanized Steel
Flammability Class	UL94V-0	Terminal	Tin-Plated Brass
Temperature Limit	105°C UL 125°C IEC	Clamp	Nickeled Brass
Color	Green		

No. Poles	Cat. #	Length (B) (mm)	Std. Pk.
2	MV-462	12.7	100
3	MV-463	19.0	100
4	MV-464	25.4	50
5	MV-465	31.7	50
6	MV-466	38.0	50
7	MV-467	44.4	50
8	MV-468	50.7	50
9	MV-469	57.0	50
10	MV-4610	63.4	50
11	MV-4611	69.7	50
12	MV-4612	76.0	50
13	MV-4613	82.4	20
14	MV-4614	88.7	20
15	MV-4615	95.0	20
16	MV-4616	101.4	20

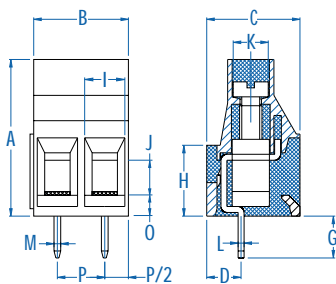

Dimensions

A	21.00 mm	I	3.10 mm
B	12.70 mm	J	3.90 mm
C	12.50 mm	K	Ø4.70 mm
D	4.20 mm	L	0.80 mm
E	—	M	0.90 mm
F	—	N	—
G	4.10 mm	O	3.30 mm
H	9.50 mm	P	6.35 mm

* 12.7mm Pin spacing available

^① 25A Factory Wiring - UL

Pin Spacing: 7.50mm
 Orientation: Vertical
 Clamp Type: Screw Cage
 Design: Modular

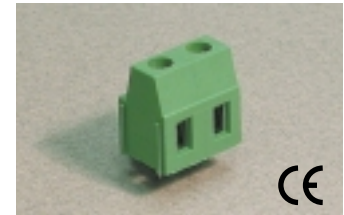

MV-27

ELECTRICAL

	Current	Voltage	Wire Range
	15A ^①	300V	30-14AWG
	16A	750V	2.5mm ² Stranded 4.0mm ² Solid

INSTALLATION DATA

Screw Size	M3	PCB Hole Size	1.3mm
Torque	0.5Nm (4.5 lbf-in.)	Stripping Lgth.	8.3mm

MATERIAL

Body	PA6.8	Screw	Galvanized Steel
Flammability Class	UL94V-0	Terminal	Tin-Plated Brass
Temperature Limit	105°C UL 125°C IEC	Clamp	Nickeled Brass
Color	Green		

No. Poles	Cat. #	Length (B) (mm)	Std. Pk.
2	MV-272	15.0	100
3	MV-273	22.5	100
4	MV-274	30.0	50
5	MV-275	37.5	50
6	MV-276	45.0	50
7	MV-277	52.5	50
8	MV-278	60.0	50
9	MV-279	67.5	50
10	MV-2710	75.0	50
11	MV-2711	82.5	50
12	MV-2712	90.0	50
13	MV-2713	97.5	20
14	MV-2714	105.0	20
15	MV-2715	112.5	20
16	MV-2716	120.0	20

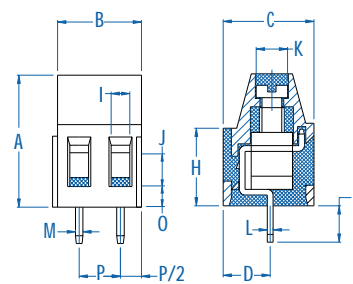

Dimensions

A	16.00 mm	I	2.80 mm
B	15.00 mm	J	2.80 mm
C	11.00 mm	K	Ø3.80 mm
D	5.30 mm	L	0.70 mm
E	—	M	0.90 mm
F	—	N	—
G	4.50 mm	O	3.60 mm
H	9.40 mm	P	7.50 mm

^① 16A Factory Wiring - UL

Fixed PCB Blocks

Pin Spacing: 7.50mm
 Orientation: Vertical
 Clamp Type: Screw Cage
 Design: Modular

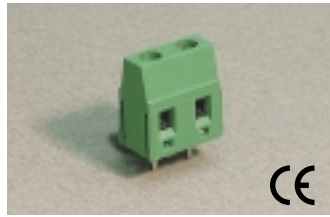

MVE-27

ELECTRICAL

	Current	Voltage	Wire Range
	15A ^①	300V	30-14AWG
	16A	750V	2.5mm ² Stranded 4.0mm ² Solid

INSTALLATION DATA

Screw Size	M3	PCB Hole Size	1.3mm
Torque	0.5Nm (4.5 lbf-in.)	Stripping Lgth.	7.1mm

MATERIAL

Body	PA6.8	Screw	Galvanized Steel
Flammability Class	UL94V-0	Terminal	Tin-Plated Brass
Temperature Limit	105°C UL 125°C IEC	Clamp	Nickel Brass
Color	Green		

No. Poles	Cat. #	Length (B) (mm)	Std. Pk.
2	MVE-272	15.0	100
3	MVE-273	22.5	100
4	MVE-274	30.0	50
5	MVE-275	37.5	50
6	MVE-276	45.0	50
7	MVE-277	52.5	50
8	MVE-278	60.0	50
9	MVE-279	67.5	50
10	MVE-2710	75.0	50
11	MVE-2711	82.5	50
12	MVE-2712	90.0	50
13	MVE-2713	97.5	20
14	MVE-2714	105.0	20
15	MVE-2715	112.5	20
16	MVE-2716	120.0	20

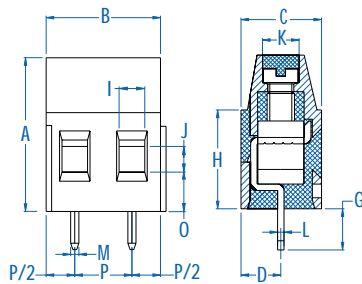

Dimensions

A	16.80 mm	I	2.80 mm
B	15.00 mm	J	2.80 mm
C	8.90 mm	K	Ø3.80 mm
D	4.35 mm	L	0.70 mm
E	-	M	0.90 mm
F	-	N	-
G	4.50 mm	O	4.60 mm
H	10.80 mm	P	7.50 mm

^① 16A Factory Wiring - UL

Pin Spacing: 7.50mm
 Orientation: Horizontal
 Clamp Type: Screw Cage
 Design: Modular

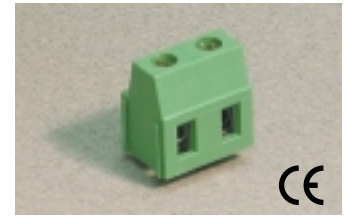

MH-27

ELECTRICAL

	Current	Voltage	Wire Range
	15A ^①	300V	30-14AWG
	16A	750V	2.5mm ² Stranded 4.0mm ² Solid

INSTALLATION DATA

Screw Size	M3	PCB Hole Size	1.3mm
Torque	0.5Nm (4.5 lbf-in.)	Stripping Lgth.	8.3mm

MATERIAL

Body	PA6.8	Screw	Galvanized Steel
Flammability Class	UL94V-0	Terminal	Tin-Plated Brass
Temperature Limit	105°C UL 125°C IEC	Clamp	Nickel Brass
Color	Green		

No. Poles	Cat. #	Length (B) (mm)	Std. Pk.
2	MH-272	15.0	100
3	MH-273	22.5	100
4	MH-274	30.0	50
5	MH-275	37.5	50
6	MH-276	45.0	50
7	MH-277	52.5	50
8	MH-278	60.0	50
9	MH-279	67.5	50
10	MH-2710	75.0	50
11	MH-2711	82.5	50
12	MH-2712	90.0	50
13	MH-2713	97.5	20
14	MH-2714	105.0	20
15	MH-2715	112.5	20
16	MH-2716	120.0	20

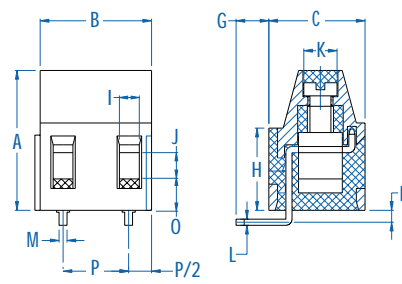

Dimensions

A	16.00 mm	I	2.80 mm
B	15.00 mm	J	2.80 mm
C	11.00 mm	K	Ø3.80 mm
D	1.70 mm	L	0.70 mm
E	-	M	0.90 mm
F	-	N	-
G	4.00 mm	O	3.60 mm
H	9.40 mm	P	7.50 mm

^① 16A Factory Wiring - UL

Fixed PCB Blocks

Pin Spacing: 7.50mm
 Orientation: Horizontal
 Clamp Type: Screw Cage
 Design: Modular

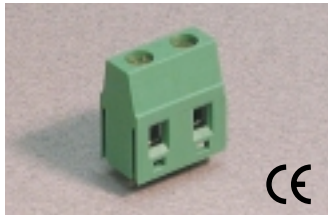

MHE-27

ELECTRICAL

	Current	Voltage	Wire Range
	15A ^①	300V	30-14AWG
	16A	750V	2.5mm ² Stranded 4.0mm ² Solid

INSTALLATION DATA

Screw Size	M3	PCB Hole Size	1.3mm
Torque	0.5Nm (4.5 lbf-in.)	Stripping Lgth.	7.1mm

MATERIAL

Body	PA6.8	Screw	Galvanized Steel
Flammability Class	UL94V-0	Terminal	Tin-Plated Brass
Temperature Limit	105°C UL 125°C IEC	Clamp	Nickeled Brass
Color	Green		

No. Poles	Cat. #	Length (B) (mm)	Std. Pk.
2	MHE-272	15.0	100
3	MHE-273	22.5	100
4	MHE-274	30.0	50
5	MHE-275	37.5	50
6	MHE-276	45.0	50
7	MHE-277	52.5	50
8	MHE-278	60.0	50
9	MHE-279	67.5	50
10	MHE-2710	75.0	50
11	MHE-2711	82.5	50
12	MHE-2712	90.0	50
13	MHE-2713	97.5	20
14	MHE-2714	105.0	20
15	MHE-2715	112.5	20
16	MHE-2716	120.0	20

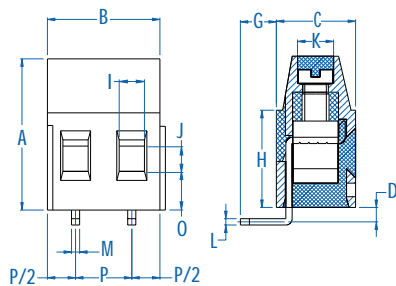

Dimensions

A	16.80 mm	I	2.80 mm
B	15.00 mm	J	2.80 mm
C	8.90 mm	K	Ø3.80 mm
D	1.40 mm	L	0.70 mm
E	—	M	0.90 mm
F	—	N	—
G	4.00 mm	O	4.60 mm
H	10.80 mm	P	7.50 mm

^① 16A Factory Wiring - UL

Pin Spacing: 7.50mm
 Orientation: Reverse Horizontal
 Clamp Type: Screw Cage
 Design: Modular



MHR-27

ELECTRICAL

	Current	Voltage	Wire Range
	15A ^①	300V	30-14AWG
	16A	450V	2.5mm ² Stranded 4.0mm ² Solid

INSTALLATION DATA

Screw Size	M3	PCB Hole Size	1.3mm
Torque	0.5Nm (4.5 lbf-in.)	Stripping Lgth.	7.1mm

MATERIAL

Body	PA6.8	Screw	Galvanized Steel
Flammability Class	UL94V-0	Terminal	Tin-Plated Brass
Temperature Limit	105°C UL 125°C IEC	Clamp	Nickeled Brass
Color	Green		

No. Poles	Cat. #	Length (B) (mm)	Std. Pk.
2	MHR-272	15.0	100
3	MHR-273	22.5	100
4	MHR-274	30.0	50
5	MHR-275	37.5	50
6	MHR-276	45.0	50
7	MHR-277	52.5	50
8	MHR-278	60.0	50
9	MHR-279	67.5	50
10	MHR-2710	75.0	50
11	MHR-2711	82.5	50
12	MHR-2712	90.0	50
13	MHR-2713	97.5	20
14	MHR-2714	105.0	20
15	MHR-2715	112.5	20
16	MHR-2716	120.0	20

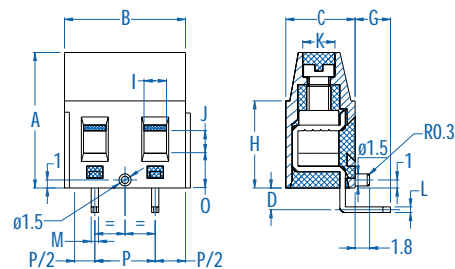

Dimensions

A	16.80 mm	I	2.80 mm
B	15.00 mm	J	2.80 mm
C	8.90 mm	K	Ø3.80 mm
D	2.30 mm	L	0.70 mm
E	—	M	0.90 mm
F	—	N	—
G	4.00 mm	O	4.60 mm
H	10.80 mm	P	7.50 mm

^① 16A Factory Wiring - UL

Fixed PCB Blocks

Pin Spacing: 7.50mm
 Orientation: 35°
 Clamp Type: Screw Cage
 Design: Modular

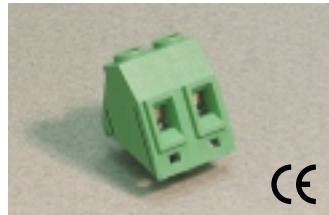

MI-27

ELECTRICAL

	Current	Voltage	Wire Range
	15A ^①	300V	30-14AWG
	16A	750V	2.5mm ² Stranded 4.0mm ² Solid

INSTALLATION DATA

Screw Size	M3	PCB Hole Size	1.3mm
Torque	0.5Nm (4.5 lbf-in.)	Stripping Lgth.	9.3mm

MATERIAL

Body	PA6.8	Screw	Galvanized Steel
Flammability Class	UL94V-0	Terminal	Tin-Plated Brass
Temperature Limit	105°C UL 125°C IEC	Clamp	Nickel Brass
Color	Green		

No. Poles	Cat. #	Length (B) (mm)	Std. Pk.
2	MI-272	15.0	100
3	MI-273	22.5	100
4	MI-274	30.0	50
5	MI-275	37.5	50
6	MI-276	45.0	50
7	MI-277	52.5	50
8	MI-278	60.0	50
9	MI-279	67.5	50
10	MI-2710	75.0	50
11	MI-2711	82.5	50
12	MI-2712	90.0	50
13	MI-2713	97.5	20
14	MI-2714	105.0	20
15	MI-2715	112.5	20
16	MI-2716	120.0	20

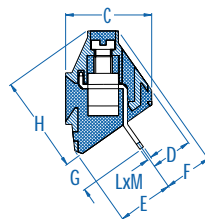
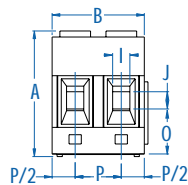

Dimensions

A	20.00 mm	I	2.80 mm
B	15.00 mm	J	2.80 mm
C	14.00 mm	K	Ø3.80 mm
D	5.00 mm	L	0.70 mm
E	9.20 mm	M	0.90 mm
F	8.00 mm	N	-
G	4.60 mm	O	6.80 mm
H	16.00 mm	P	7.50 mm

Pin Spacing: 7.62mm
 Orientation: Vertical
 Clamp Type: Screw Cage
 Design: Modular

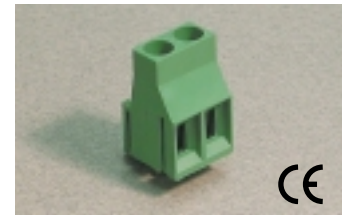

MV-47

ELECTRICAL

	Current	Voltage	Wire Range
	20A ^①	300V	30-12AWG
	25A	750V	4.0mm ² Stranded 6.0mm ² Solid

INSTALLATION DATA

Screw Size	M3	PCB Hole Size	1.3mm
Torque	0.5Nm (4.5 lbf-in.)	Stripping Lgth.	9.8mm

MATERIAL

Body	PA6.8	Screw	Galvanized Steel
Flammability Class	UL94V-0	Terminal	Tin-Plated Brass
Temperature Limit	105°C UL 125°C IEC	Clamp	Nickel Brass
Color	Green		

No. Poles	Cat. #	Length (B) (mm)	Std. Pk.
2	MV-472	15.2	100
3	MV-473	22.9	100
4	MV-474	30.5	50
5	MV-475	38.1	50
6	MV-476	45.7	50
7	MV-477	53.3	50
8	MV-478	61.0	50
9	MV-479	68.6	50
10	MV-4710	76.2	50
11	MV-4711	83.8	50
12	MV-4712	91.4	50
13	MV-4713	99.1	20
14	MV-4714	106.7	20
15	MV-4715	114.3	20
16	MV-4716	121.9	20

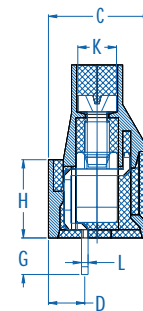
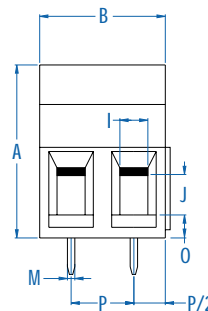

Dimensions

A	21.00 mm	I	3.10 mm
B	15.24 mm	J	3.90 mm
C	12.50 mm	K	Ø4.70 mm
D	4.20 mm	L	0.80 mm
E	-	M	0.90 mm
F	-	N	-
G	4.10 mm	O	3.30 mm
H	9.50 mm	P	7.62 mm

① 16A Factory Wiring - UL

① 25A Factory Wiring - UL

Fixed PCB Blocks

Pin Spacing: 7.62mm
 Orientation: Vertical
 Clamp Type: Screw Cage
 Design: Modular

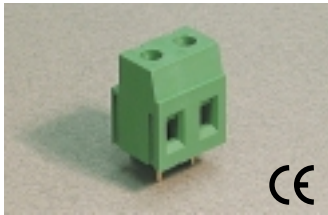

MVSP-27

ELECTRICAL

	Current	Voltage	Wire Range
	15A ^①	300V	30-14AWG
	24A	750V	2.5mm ² Stranded 4.0mm ² Solid

INSTALLATION DATA

Screw Size	M3	PCB Hole Size	1.5mm
Torque	0.5Nm (4.5 lbf-in.)	Stripping Lgth.	9.5mm

MATERIAL

Body	PA6.8	Screw	Galvanized Steel
Flammability Class	UL94V-0	Terminal	Tin-Plated Brass
Temperature Limit	105°C UL 125°C IEC	Clamp	Nickel Brass
Color	Green		

No. Poles	Cat. #	Length (B) (mm)	Std. Pk.
2	MVSP-272	15.2	100
3	MVSP-273	22.9	100
4	MVSP-274	30.5	50
5	MVSP-275	38.1	50
6	MVSP-276	45.7	50
7	MVSP-277	53.3	50
8	MVSP-278	61.0	50
9	MVSP-279	68.6	50
10	MVSP-2710	76.2	50
11	MVSP-2711	83.8	50
12	MVSP-2712	91.4	50
13	MVSP-2713	99.1	20
14	MVSP-2714	106.7	20
15	MVSP-2715	114.3	20
16	MVSP-2716	121.9	20

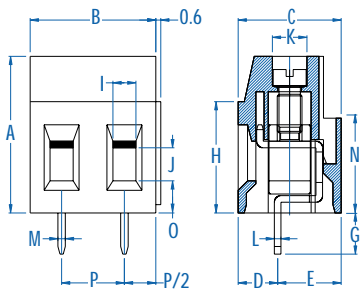

Dimensions

A	19.00 mm	I	2.80 mm
B	15.24 mm	J	4.00 mm
C	12.50 mm	K	Ø4.00 mm
D	4.80 mm	L	0.80 mm
E	7.70 mm	M	1.00 mm
F	-	N	11.50 mm
G	5.00 mm	O	3.90 mm
H	13.50 mm	P	7.62 mm

^① 20A Factory Wiring - UL

Pin Spacing: 7.62mm
 Orientation: Horizontal
 Clamp Type: Screw Cage
 Design: Modular



MHSP-27

ELECTRICAL

	Current	Voltage	Wire Range
	15A ^①	300V	30-14AWG
	24A	750V	2.5mm ² Stranded 4.0mm ² Solid

INSTALLATION DATA

Screw Size	M3	PCB Hole Size	1.5mm
Torque	0.5Nm (4.5 lbf-in.)	Stripping Lgth.	9.5mm

MATERIAL

Body	PA6.8	Screw	Galvanized Steel
Flammability Class	UL94V-0	Terminal	Tin-Plated Brass
Temperature Limit	105°C UL 125°C IEC	Clamp	Nickel Brass
Color	Green		

No. Poles	Cat. #	Length (B) (mm)	Std. Pk.
2	MHSP-272	15.2	100
3	MHSP-273	22.9	100
4	MHSP-274	30.5	50
5	MHSP-275	38.1	50
6	MHSP-276	45.7	50
7	MHSP-277	53.3	50
8	MHSP-278	61.0	50
9	MHSP-279	68.6	50
10	MHSP-2710	76.2	50
11	MHSP-2711	83.8	50
12	MHSP-2712	91.4	50
13	MHSP-2713	99.1	20
14	MHSP-2714	106.7	20
15	MHSP-2715	114.3	20
16	MHSP-2716	121.9	20

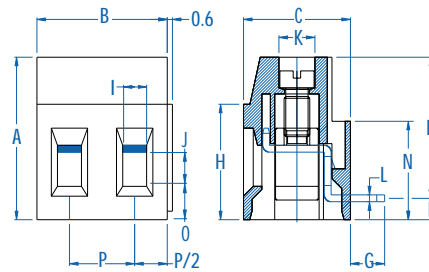

Dimensions

A	19.00 mm	I	2.80 mm
B	15.24 mm	J	4.00 mm
C	12.50 mm	K	Ø4.00 mm
D	16.50 mm	L	0.80 mm
E	2.50 mm	M	1.00 mm
F	-	N	11.50 mm
G	4.00 mm	O	3.90 mm
H	13.50 mm	P	7.62 mm

^① 20A Factory Wiring - UL

Fixed PCB Blocks

Pin Spacing: 9.52mm/ 19.04mm*
 Orientation: Vertical
 Clamp Type: Screw Cage
 Design: Modular

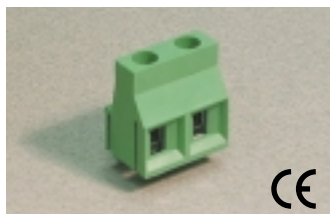

MV-49

ELECTRICAL

	Current	Voltage	Wire Range
	20A ^①	300V	30-12AWG
	25A	750V	4.0mm ² Stranded 6.0mm ² Solid

INSTALLATION

DATA

Screw Size	M3	PCB Hole Size	1.3mm
Torque	0.5Nm (4.5 lbf-in.)	Stripping Lgth.	9.8mm

MATERIAL

Body	PA6.8	Screw	Galvanized Steel
Flammability Class	UL94V-0	Terminal	Tin-Plated Brass
Temperature Limit	105°C UL 125°C IEC	Clamp	Nickeled Brass
Color	Green		

No. Poles	Cat. #	Length (B) (mm)	Std. Pk.
2	MV-492	19.0	100
3	MV-493	28.6	100
4	MV-494	38.1	50
5	MV-495	47.6	50
6	MV-496	57.1	50
7	MV-497	66.6	50
8	MV-498	76.2	50
9	MV-499	85.7	50
10	MV-4910	95.2	50
11	MV-4911	104.7	50
12	MV-4912	114.2	50
13	MV-4913	123.8	20
14	MV-4914	133.3	20
15	MV-4915	142.8	20
16	MV-4916	152.3	20

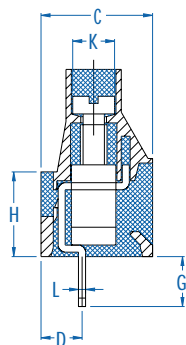
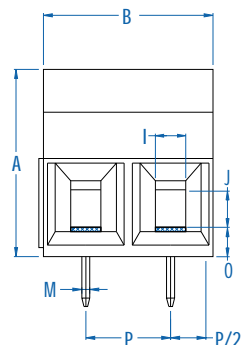

Dimensions

A	21.00 mm	I	3.10 mm
B	19.04 mm	J	3.90 mm
C	12.50 mm	K	Ø4.70 mm
D	4.20 mm	L	0.80 mm
E	-	M	0.90 mm
F	-	N	-
G	4.10 mm	O	3.30 mm
H	9.50 mm	P	9.52 mm

*19.04mm pin spacing available

^① 25A Factory Wiring - UL

Pin Spacing: 10.00mm
 Orientation: Vertical
 Clamp Type: Box with Wire Protector
 Design: Modular

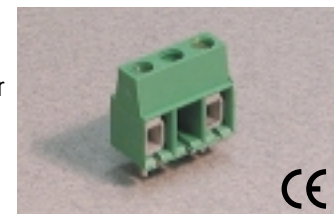

MVEB-15

ELECTRICAL

	Current	Voltage	Wire Range
	10A	600V	30-16AWG
	17.5A	750V	1.5mm ² Stranded 2.5mm ² Solid

INSTALLATION

DATA

Screw Size	M2.5	PCB Hole Size	1.5mm
Torque	0.4Nm (3.6 lbf-in.)	Stripping Lgth.	6.8mm

MATERIAL

Body	PA6.8	Screw	Galvanized Steel
Flammability Class	UL94V-0	Terminal	Tin-Plated Brass
Temperature Limit	105°C UL 125°C IEC	Wire Protector	Tin-Plated Bronze
Color	Green		

No. Poles	Cat. #	Length (B) (mm)	Std. Pk.
2	MVEB-152	15.0	100
3	MVEB-153	25.0	50
4	MVEB-154	35.0	50
5	MVEB-155	45.0	50
6	MVEB-156	55.0	50
7	MVEB-157	65.0	50
8	MVEB-158	75.0	20
9	MVEB-159	85.0	20
10	MVEB-1510	95.0	20
11	MVEB-1511	105.0	20
12	MVEB-1512	115.0	20

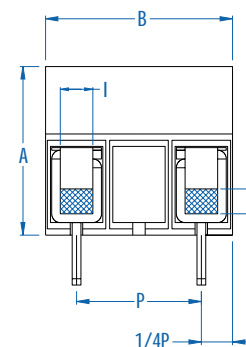
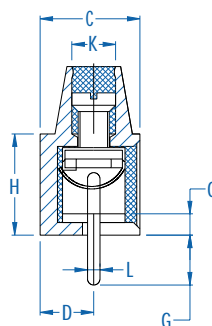

Dimensions

A	13.50 mm	I	2.60 mm
B	15.00 mm	J	2.00 mm
C	8.00 mm	K	Ø3.40 mm
D	4.00 mm	L	1.10 mm
E	-	M	0.70 mm
F	-	N	-
G	4.10 mm	O	1.70 mm
H	8.10 mm	P	10.00 mm

Fixed PCB Blocks

Pin Spacing: 10.00mm
 Orientation: Vertical
 Clamp Type: Screw Cage
 Design: Modular

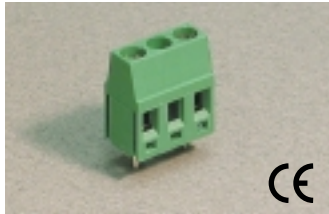

MVEB-25

ELECTRICAL

	Current	Voltage	Wire Range
	15A ^①	600V	30-14AWG
	16A	750V	2.5mm ² Stranded 4.0mm ² Solid

INSTALLATION DATA

Screw Size	M3	PCB Hole Size	1.3mm
Torque	0.5Nm (4.5 lbf-in.)	Stripping Lgth.	7.1mm

MATERIAL

Body	PA6.8	Screw	Galvanized Steel
Flammability Class	UL94V-0	Terminal	Tin-Plated Brass
Temperature Limit	105°C UL 125°C IEC	Clamp	Nickel Brass
Color	Green		

No. Poles	Cat. #	Length (B) (mm)	Std. Pk.
2	MVEB-252	15.0	100
3	MVEB-253	25.0	50
4	MVEB-254	35.0	50
5	MVEB-255	45.0	50
6	MVEB-256	55.0	50
7	MVEB-257	65.0	50
8	MVEB-258	75.0	20
9	MVEB-259	85.0	20
10	MVEB-2510	95.0	20
11	MVEB-2511	105.0	20
12	MVEB-2512	115.0	20

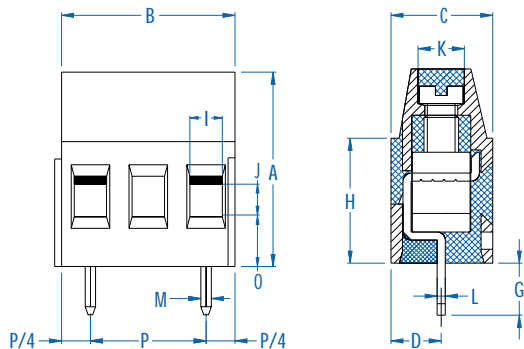

Dimensions

A	16.80 mm	I	2.80 mm
B	15.00 mm	J	2.80 mm
C	8.90 mm	K	Ø3.80 mm
D	4.35 mm	L	0.70 mm
E	-	M	0.90 mm
F	-	N	-
G	4.50 mm	O	4.60 mm
H	10.80 mm	P	10.00 mm

^① 16A Factory Wiring - UL

Pin Spacing: 10.00mm
 Orientation: Horizontal
 Clamp Type: Screw Cage
 Design: Modular

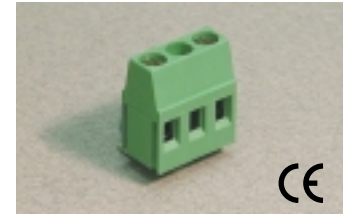

MHEB-25

ELECTRICAL

	Current	Voltage	Wire Range
	15A ^①	600V	30-14AWG
	16A	750V	2.5mm ² Stranded 4.0mm ² Solid

INSTALLATION DATA

Screw Size	M3	PCB Hole Size	1.3mm
Torque	0.5Nm (4.5 lbf-in.)	Stripping Lgth.	7.1mm

MATERIAL

Body	PA6.8	Screw	Galvanized Steel
Flammability Class	UL94V-0	Terminal	Tin-Plated Brass
Temperature Limit	105°C UL 125°C IEC	Clamp	Nickel Brass
Color	Green		

No. Poles	Cat. #	Length (B) (mm)	Std. Pk.
2	MHEB-252	15.0	100
3	MHEB-253	25.0	50
4	MHEB-254	35.0	50
5	MHEB-255	45.0	50
6	MHEB-256	55.0	50
7	MHEB-257	65.0	50
8	MHEB-258	75.0	20
9	MHEB-259	85.0	20
10	MHEB-2510	95.0	20
11	MHEB-2511	105.0	20
12	MHEB-2512	115.0	20

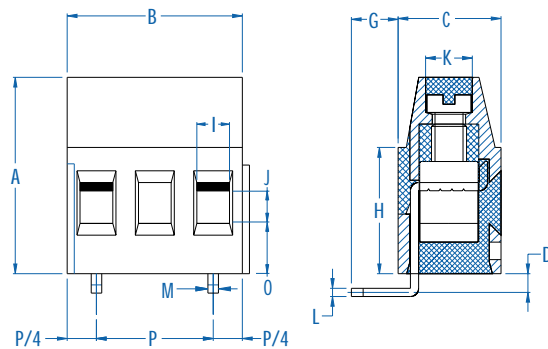

Dimensions

A	16.80 mm	I	2.80 mm
B	15.00 mm	J	2.80 mm
C	8.90 mm	K	Ø3.80 mm
D	1.40 mm	L	0.70 mm
E	-	M	0.90 mm
F	-	N	-
G	4.00 mm	O	4.60 mm
H	10.80 mm	P	10.00 mm

^① 16A Factory Wiring - UL

Pin Spacing: 10.16mm
 Orientation: Vertical
 Clamp Type: Screw Cage
 Design: Modular

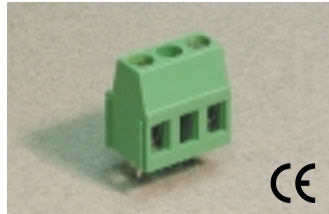

MVB-25

ELECTRICAL

	Current	Voltage	Wire Range
	15A ^①	300V	30-14AWG
	16A	750V	2.5mm ² Stranded 4.0mm ² Solid

INSTALLATION DATA

Screw Size	M3	PCB Hole Size	1.3mm
Torque	0.5Nm (4.5 lbf-in.)	Stripping Lgth.	8.3mm

MATERIAL

Body	PA6.8	Screw	Galvanized Steel
Flammability Class	UL94V-0	Terminal	Tin-Plated Brass
Temperature Limit	105°C UL 125°C IEC	Clamp	Nickeled Brass
Color	Green		

No. Poles	Cat. #	Length (B) (mm)	Std. Pk.
2	MVB-252	15.2	100
3	MVB-253	25.4	50
4	MVB-254	35.6	50
5	MVB-255	45.7	50
6	MVB-256	55.9	50
7	MVB-257	66.0	50
8	MVB-258	76.2	20
9	MVB-259	86.4	20
10	MVB-2510	96.5	20
11	MVB-2511	106.7	20
12	MVB-2512	116.8	20

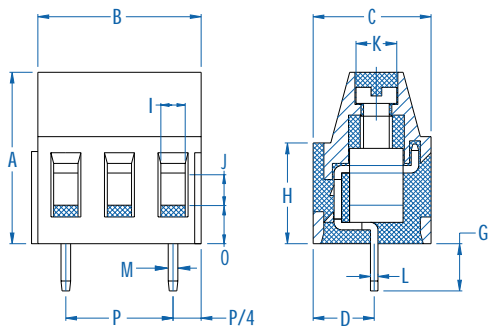

Dimensions

A	16.00 mm	I	2.80 mm
B	15.24 mm	J	2.80 mm
C	11.00 mm	K	Ø3.80 mm
D	5.00 mm	L	0.70 mm
E	-	M	0.90 mm
F	-	N	-
G	4.50 mm	O	3.60 mm
H	9.40 mm	P	10.16 mm

^① 16A Factory Wiring - UL

Pin Spacing: 10.16mm
 Orientation: Horizontal
 Clamp Type: Screw Cage
 Design: Modular

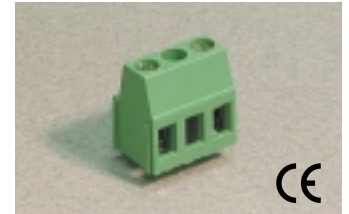

MHB-25

ELECTRICAL

	Current	Voltage	Wire Range
	15A ^①	300V	30-14AWG
	16A	750V	2.5mm ² Stranded 4.0mm ² Solid

INSTALLATION DATA

Screw Size	M3	PCB Hole Size	1.3mm
Torque	0.5Nm (4.5 lbf-in.)	Stripping Lgth.	8.3mm

MATERIAL

Body	PA6.8	Screw	Galvanized Steel
Flammability Class	UL94V-0	Terminal	Tin-Plated Brass
Temperature Limit	105°C UL 125°C IEC	Clamp	Nickeled Brass
Color	Green		

No. Poles	Cat. #	Length (B) (mm)	Std. Pk.
2	MHB-252	15.2	100
3	MHB-253	25.4	50
4	MHB-254	35.6	50
5	MHB-255	45.7	50
6	MHB-256	55.9	50
7	MHB-257	66.0	50
8	MHB-258	76.2	20
9	MHB-259	86.4	20
10	MHB-2510	96.5	20
11	MHB-2511	106.7	20
12	MHB-2512	116.8	20

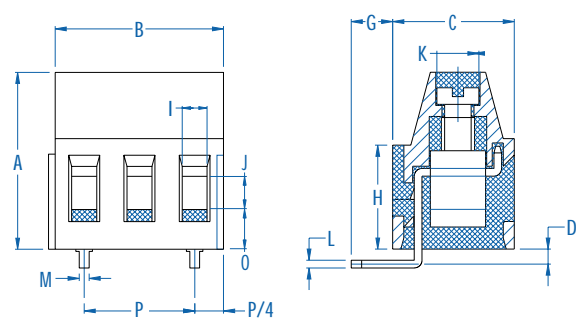

Dimensions

A	16.00 mm	I	2.80 mm
B	15.24 mm	J	2.80 mm
C	11.00 mm	K	Ø3.80 mm
D	2.00 mm	L	0.70 mm
E	-	M	0.90 mm
F	-	N	-
G	4.00 mm	O	3.60 mm
H	9.40 mm	P	10.16 mm

^① 16A Factory Wiring - UL

Fixed PCB Blocks

Pin Spacing: 10.16mm
 Orientation: Vertical
 Clamp Type: Screw Cage
 Design: Modular

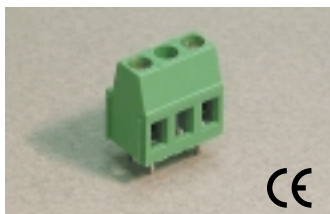

MVB-25-D

ELECTRICAL

	Current	Voltage	Wire Range
	15A ^①	300V	30-14AWG
	24A	750V	2.5mm ² Stranded 4.0mm ² Solid

INSTALLATION DATA

Screw Size	M3	PCB Hole Size	1.3mm
Torque	0.5Nm (4.5 lbf-in.)	Stripping Lgth.	8.3mm

MATERIAL

Body	PA6.8	Screw	Galvanized Steel
Flammability Class	UL94V-0	Terminal	Tin-Plated Brass
Temperature Limit	105°C UL 125°C IEC	Clamp	Nickel Brass
Color	Green		

No. Poles	Cat. #	Length (B) (mm)	Std. Pk.
2	MVB-252-D	15.2	100
3	MVB-253-D	25.4	50
4	MVB-254-D	35.6	50
5	MVB-255-D	45.7	50
6	MVB-256-D	55.9	50
7	MVB-257-D	66.0	50
8	MVB-258-D	76.2	20
9	MVB-259-D	86.4	20
10	MVB-2510-D	96.5	20
11	MVB-2511-D	106.7	20
12	MVB-2512-D	116.8	20

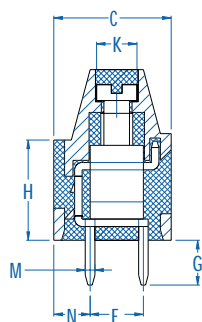
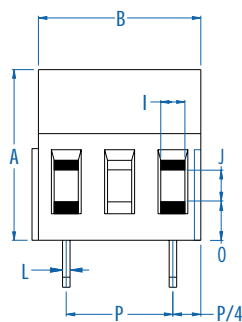

Dimensions

A	16.00 mm	I	2.80 mm
B	15.24 mm	J	2.80 mm
C	11.00 mm	K	Ø3.80 mm
D	—	L	0.70 mm
E	5.00 mm	M	0.90 mm
F	—	N	3.40 mm
G	4.50 mm	O	3.60 mm
H	9.40 mm	P	10.16 mm

^① 18A Factory Wiring - UL

Pin Spacing: 10.16mm
 Orientation: Vertical-Double Level
 Clamp Type: Screw Cage
 Design: Modular-Aligned



MVDKB-25

ELECTRICAL

	Current	Voltage	Wire Range
	15A ^①	300V	30-14AWG
	16A	750V	2.5mm ² Stranded 4.0mm ² Solid

INSTALLATION DATA

Screw Size	M3	PCB Hole Size	1.3mm
Torque	0.5Nm (4.5 lbf-in.)	Stripping Lgth.	8.3mm

MATERIAL

Body	PA6.8	Screw	Galvanized Steel
Flammability Class	UL94V-0	Terminal	Tin-Plated Brass
Temperature Limit	105°C UL 125°C IEC	Clamp	Nickel Brass
Color	Green		

No. Poles	Cat. #	Length (B) (mm)	Std. Pk.
4	MVDKB-252	15.2	100
6	MVDKB-253	25.4	50
8	MVDKB-254	35.6	50
10	MVDKB-255	45.7	50
12	MVDKB-256	55.9	20
14	MVDKB-257	66.0	20
16	MVDKB-258	76.2	20
18	MVDKB-259	86.4	20
20	MVDKB-2510	96.5	10
22	MVDKB-2511	106.7	10
24	MVDKB-2512	116.8	10

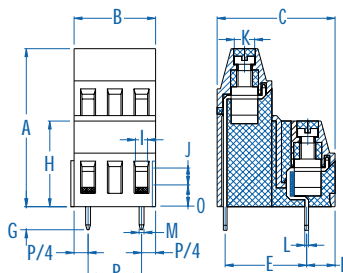

Dimensions

A	29.50 mm	I	2.80 mm
B	15.24 mm	J	2.80 mm
C	22.00 mm	K	Ø3.80 mm
D	5.30 mm	L	0.70 mm
E	15.24 mm	M	0.90 mm
F	—	N	—
G	4.70 mm	O	3.60 mm
H	16.00 mm	P	10.16 mm

^① 16A Factory Wiring - UL

Pin Spacing: 10.16mm
 Orientation: Vertical-Double Level
 Clamp Type: Screw Cage
 Design: Modular

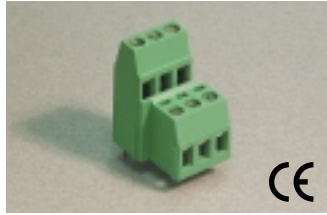

MVDB-25

ELECTRICAL

	Current	Voltage	Wire Range
	15A ^①	300V	30-14AWG
	16A	750V	2.5mm ² Stranded 4.0mm ² Solid

INSTALLATION

DATA

Screw Size	M3	PCB Hole Size	1.3mm
Torque	0.5Nm (4.5 lbf-in.)	Stripping Lgth.	8.3mm

MATERIAL

Body	PA6.8	Screw	Galvanized Steel
Flammability Class	UL94V-0	Terminal	Tin-Plated Brass
Temperature Limit	105°C UL 125°C IEC	Clamp	Nickeled Brass
Color	Green		

No. Poles	Cat. #	Length (B) (mm)	Std. Pk.
4	MVDB-252	17.8	100
6	MVDB-253	30.5	50
8	MVDB-254	43.2	50
10	MVDB-255	55.9	50
12	MVDB-256	68.6	20
14	MVDB-257	81.3	20
16	MVDB-258	94.0	20
18	MVDB-259	106.7	20
20	MVDB-2510	119.4	10
22	MVDB-2511	132.1	10
24	MVDB-2512	144.8	10

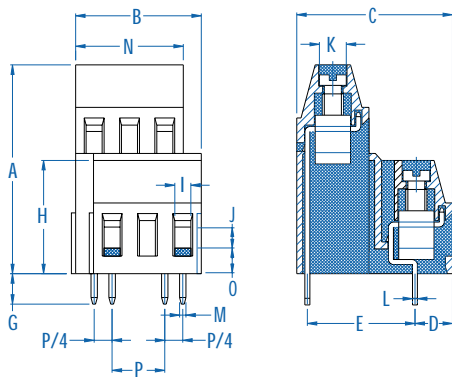

Dimensions

A	29.50 mm	I	2.80 mm
B	17.78 mm	J	2.80 mm
C	22.00 mm	K	Ø3.80 mm
D	5.30 mm	L	0.70 mm
E	15.24 mm	M	0.90 mm
F	—	N	15.24 mm
G	4.70 mm	O	3.60 mm
H	16.00 mm	P	10.16 mm

^① 16A Factory Wiring - UL

Pin Spacing: 10.16mm
 Orientation: Vertical-Triple Level
 Clamp Type: Screw Cage
 Design: Modular

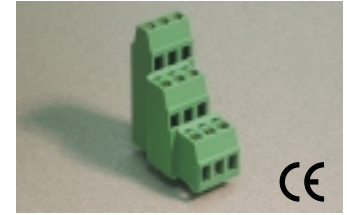

MVTB-25

ELECTRICAL

	Current	Voltage	Wire Range
	15A ^①	300V	30-14AWG
	16A	750V	2.5mm ² Stranded 4.0mm ² Solid

INSTALLATION

DATA

Screw Size	M3	PCB Hole Size	1.3mm
Torque	0.5Nm (4.5 lbf-in.)	Stripping Lgth.	8.3mm

MATERIAL

Body	PA6.8	Screw	Galvanized Steel
Flammability Class	UL94V-0	Terminal	Tin-Plated Brass
Temperature Limit	105°C UL 125°C IEC	Clamp	Nickeled Brass
Color	Green		

No. Poles	Cat. #	Length (B) (mm)	Std. Pk.
6	MVTB-252	17.8	50
9	MVTB-253	30.5	30
12	MVTB-254	43.2	30
15	MVTB-255	55.9	30
18	MVTB-256	68.6	15
21	MVTB-257	81.3	15
24	MVTB-258	94.0	15
27	MVTB-259	106.7	15
30	MVTB-2510	119.4	5
33	MVTB-2511	132.1	5
36	MVTB-2512	144.8	5

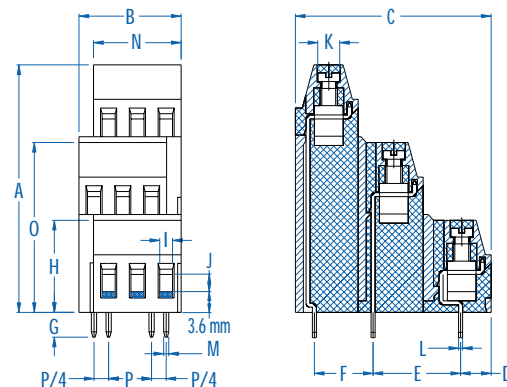

Dimensions

A	43.00 mm	I	2.80 mm
B	17.78 mm	J	2.80 mm
C	34.00 mm	K	Ø3.80 mm
D	5.30 mm	L	0.70 mm
E	15.24 mm	M	0.90 mm
F	10.16 mm	N	15.24 mm
G	4.50 mm	O	29.50 mm
H	16.00 mm	P	10.16 mm

^① 16A Factory Wiring - UL

INDEX

PART #	PAGE	PART #	PAGE
CMR-10	49	MVEB-25	24
CMR-75	49	MVI	39
MBE-15	7	MVS-15	8
MBES-15	12	MVSP-25	14
MH-15	10	MVSP-27	22
MH-25	14	MVT-25	17
MH-27	19	MVTB-25	27
MHB-25	25	PDSH-10.16	48
MHE-13	9	PDSH-5.08	37
MHE-16	10	PDSV-5.08	37
MHE-25	11	PDSV-10.16	47
MHE-27	20	PH-10.00	44
MHEB-25	24	PH-10.16	46
MHR-25	11	PH-5.00	32
MHR-27	20	PH-5.08	36
MHSP-25	15	PH-5.08-K	39
MHSP-27	22	PH-7.50	41
MI-25 (35)	15	PHP-10.00	44
MI-25 (45)	16	PHP-10.16	47
MI-25 (5.00)	12	PHP-5.00	33
MI-27	21	PHP-5.08	36
MPT-275	49	PHP-7.50	42
MPT-410	49	PV-10.00	43
MT-210	48	PV-10.16	45
MV-15	8	PV-5.00	31
MV-25	13	PV-5.08	35
MV-25-D	13	PV-5.08-K	38
MV-27	18	PV-7.50	40
MV-46	18	PVP-10.00	43
MV-47	21	PVP-10.16	46
MV-49	23	PVP-5.00	32
MVB-25	25	PVP-5.08	35
MVB-25-D	26	PVP-7.50	41
MVD-25	16	PVS-5.00	30
MVDB-25	27	SH-10.00	42
MVDK-25	17	SH-10.16	45
MVDKB-25	26	SH-5.00	31
MVE-15	7	SH-5.08	33
MVE-25	9	SH-5.08-K	38
MVE-27	19	SH-7.50	40
MVE-35	6	SHS-5.00	30
MVE-38	6	SVF-5.08	34
MVEB-15	23	SVP-5.08	34

COMMONLY USED METRIC AND OTHER USEFUL CONVERSIONS

Length inch [in.] x 25.4 =millimeters millimeters [mm] x 0.03937 =inches meters [m] x 3.281 =feet miles [mi] x 1.609 =kilometers kilometers [km] x 0.6214 =miles Torque Newtonmeter [Nm] x 0.738 =lb-ft lb-ft x 1.356 =Nm lb-in x 0.113 =Nm oz-in x 0.0071 =Nm Power kilowatt [kW] x 1.341 =hp hp x 0.7457 =kW Moment of Inertia (WR2) lb-ft2 x 0.042 =kgm2 kilogrammeter2 [kgm2] 23.720 =lb-ft2 Weight Mass and Force Newton [N] x 0.02248 =pound kilogram [kg] x 2.205 =pounds pound [lb] x 4.448 =N pound [lb] x 0.4536 =kg	Metric Cross-Sectional Areas a		American Wire Gauge		Metric Cross-Sections Areas		American Wire Gauge	
	Cross-Sectional Area mm2	Equivalent Metric Area mm2	AWG or MCM	Cross-Sectional Area mm2	Equivalent Metric Area mm2	AWG or MCM		
0.50	0.519	20 AWG	25.0	21.15	4 AWG			
0.75	0.653	19	35.0	26.67	3			
	0.823	18		33.63	2			
	1.04	17		42.41	1			
	1.31	16	50.0	53.48	1/0			
1.5	1.65	15	70.0	67.43	2/0			
	2.08	14	95.0	85.03	3/0			
2.5	2.62	13		107.20	4/0			
	3.31	12	120.0	126.64	250 MCM			
	4.17	11	150.0	152.00	300			
4.0	5.26	10	185.0	177.35	350			
	6.63	9	240.0	202.71	400			
	8.37	8	300.0	253.35	500			
10.0	10.55	7	400.0	380.00	750			
	13.30	6	500.0	506.71	1000			
16.0	16.77	5	625.0					

^aAs per IEC Publ. 228

DEGREES CELSIUS VERSUS DEGREES FAHRENHEIT															
°C	°F	°C	°F	°C	°F	°C	°F	°C	°F	°C	°F	°C	°F	°C	°F
-80	-112.0	-20	-4.0	5	41.0	30	86.0	55	131.0	80	176.0	105	221.0	130	266.0
-70	-94.0	-19	-2.2	6	42.8	31	87.8	56	132.8	81	177.8	106	222.8	131	267.8
-60	-65.0	-18	-0.4	7	44.6	32	89.6	57	134.6	82	179.6	107	224.6	132	269.6
-50	-58.0	-17	+1.4	8	46.4	33	91.4	58	136.4	83	181.4	108	226.4	133	271.4
-45	-49.1	-16	3.2	9	48.2	34	93.2	59	138.2	84	183.2	109	228.2	134	273.2
-40	-40.0	-15	5.0	10	50.0	35	95.0	60	140.0	85	185.0	110	230.0	135	275.0
-39	-38.2	-14	6.8	11	51.8	36	96.8	61	141.8	86	186.8	111	231.8	136	276.8
-38	-36.4	-13	8.6	12	53.6	37	98.6	62	143.6	87	188.6	112	233.6	137	278.6
-37	-34.6	-12	10.4	13	55.4	38	100.4	63	145.4	88	189.4	113	235.4	138	280.4
-36	-32.8	-11	12.2	14	57.2	39	102.2	64	147.2	89	192.2	114	237.2	139	282.2
-35	-31.0	-10	14.0	15	59.0	40	104.0	65	149.0	90	194.0	115	239.0	140	284.0
-34	-29.2	-9	15.8	16	60.8	41	105.8	66	150.8	91	195.8	116	240.8	141	285.8
-33	-27.4	-8	17.6	17	62.6	42	107.6	67	152.6	92	197.6	117	242.6	142	287.6
-32	-25.6	-7	19.4	18	64.4	43	109.4	68	154.4	93	199.4	118	244.4	143	289.4
-31	-23.8	-6	21.2	19	66.2	44	111.2	69	156.2	94	201.2	119	246.2	144	291.2
-30	-22.0	-5	23.0	20	68.0	45	113.0	70	158.0	95	203.0	120	248.0	145	293.0
-29	-22.0	-4	24.8	21	69.8	46	114.8	71	159.8	96	204.8	121	249.8	146	294.8
-28	-18.4	-3	26.6	22	71.6	47	116.6	72	161.6	97	206.6	122	251.6	147	296.6
-27	-16.6	-2	28.4	23	73.4	48	118.4	73	163.4	98	208.4	123	253.4	148	298.4
-26	-14.8	-1	30.2	24	75.2	49	120.2	74	165.2	99	210.2	124	255.2	149	300.2
-25	-13.0	0	32.0	25	77.0	50	122.0	75	167.0	100	212.0	125	257.0	150	302.0
-24	-11.2	1	33.8	26	78.8	51	123.8	76	168.8	101	213.8	126	258.8	160	320.0
-23	-9.4	2	35.6	27	80.6	52	125.6	77	170.6	102	215.6	127	260.6	170	338.0
-22	-7.6	3	37.4	28	82.4	53	127.4	78	172.4	103	217.4	128	262.4	180	356.0
-21	-5.8	4	39.2	29	84.2	54	129.2	79	174.2	104	219.2	129	264.2	190	374.0
														2000	3632

Conversion Formula °F = 9/5°C + 32° °C = 5/9(°F-32°)

Mouser Electronics

Authorized Distributor

Click to View Pricing, Inventory, Delivery & Lifecycle Information:

Altech:

[MVT-255](#) [MVT-257](#) [MVT-253](#) [MVT-259](#) [MVT-252](#) [MVT-256](#) [MVT-258](#) [MVT-254](#) [MVB-2511-D](#) [MV-4714](#) [MV-4712](#) [MV-4716](#) [MV-4710](#) [MV-4715](#) [MV-4711](#) [MV-4713](#) [MI-2516 \(45\)](#) [MVEB-1510](#) [MVEB-1512](#) [MVEB-1511](#) [MI-2516 \(35\)](#) [MV-2510/-8.-7](#) [MI-253 \(45\)](#) [MI-253 \(35\)](#) [MV-2711](#) [MV-2715](#) [MV-2713](#) [MV-2714](#) [MV-2710](#) [MV-2712](#) [MV-2716](#) [MV-2517-D](#) [MVI-5](#) [MVI-9](#) [MVI-7](#) [MVI-3](#) [MVI-2](#) [MVI-6](#) [MVI-4](#) [MVI-8](#) [MV-2521-D](#) [MI-2516 \(5.00\)](#) [MV-259-D](#) [MVTB-2510](#) [MVTB-2512](#) [MVTB-2511](#) [MI-259\(5.00\)](#) [MV-2511-D](#) [MVEB-257](#) [MVEB-253](#) [MVEB-255](#) [MVEB-259](#) [MVEB-252](#) [MVEB-256](#) [MVEB-258](#) [MVEB-254](#) [MV-2523-D](#) [MVB-258-D](#) [MVS-1524](#) [MVS-1521](#) [MVS-1522](#) [MVS-1520](#) [MVS-1523](#) [MV-257-D](#) [MVS-1512](#) [MT-2103-10-C](#) [MVS-1513](#) [MVS-1515](#) [MVS-1519](#) [MVS-1514](#) [MVS-1518](#) [MVS-1510](#) [MVS-1516](#) [MVS-1517](#) [MVS-1511](#) [MV-2519-D](#) [MI-274](#) [MI-273](#) [MI-277](#) [MI-275](#) [MI-279](#) [MI-278](#) [MI-272](#) [MI-276](#) [MI-252 \(35\)](#) [MV-253-D](#) [MV-2515-D](#) [MV-475](#) [MV-479](#) [MV-477](#) [MV-473](#) [MV-472](#) [MV-476](#) [MV-474](#) [MV-478](#) [MVB-254-D](#) [MV-494](#) [MV-498](#) [MV-496](#) [MV-492](#)