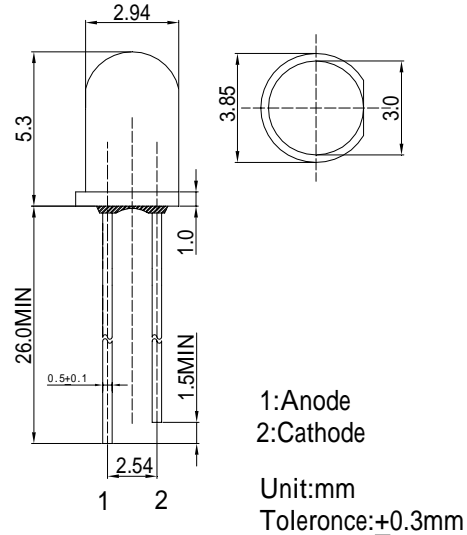

**Features**

- High Luminous LEDs
- 3mm Standard Directivity
- Superior Weather-resistance
- Flashing Type
- Water Clear Type

**Applications**

- Toys
- Games
- Audio
- Other Lighting

**Outline Dimension**

**■ Absolute Maximum Rating (Ta=25 °C)**

Item	Symbol	Value	Unit
Oscillator Frequency	Fled	1.8	Hz
Power Supply	Voltage	4.5	V
Operating Temperature	Topr	-30 ~ +85	
Storage Temperature	Tstg	-40 ~ +100	
Lead Soldering Temperature	Tsol	260 /5sec	-

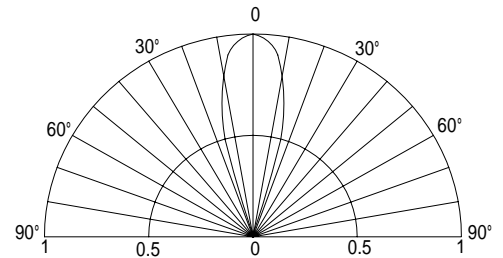
\*Pulse width Max.10ms Duty ratio max 1/10

**■ Directivity**

**■ Electrical -Optical Characteristics (Ta=25 °C)**

Item	Symbol	Condition	Min.	Typ.	Max.	Unit
DC Forward Voltage	V <sub>dd</sub>	I <sub>F</sub> =20mA	3.0	3.3	4.5	V
DC Reverse Current	I <sub>R</sub>	V <sub>R</sub> =5V	-	-	10	μA
Domi. Wavelength*	λ <sub>D</sub>	I <sub>F</sub> =20mA	600	605	610	nm
Luminous Intensity*	I <sub>v</sub>	I <sub>F</sub> =20mA	-	3500	-	mcd
50% Power Angle	2θ <sub>1/2</sub>	I <sub>F</sub> =20mA	-	30	-	deg

\*1 Tolerance of dominant wavelength is +1nm

\*2 Tolerance of luminous intensity is +15%