

FEATURES

- 21.5 dB Gain
- Very Low Distortion
- Excellent 75-Ohm Input and Output Match
- Stable with High VSWR Load Conditions
- Monolithic Design for Consistent Performance Part-to-Part
- Low DC Power Consumption
- Surface Mount Package Compatible with Automatic Assembly
- Low Cost Alternative to Hybrids
- Meets Cenelec Standards

APPLICATIONS

- CATV Line Amplifiers, System Amplifiers, Distribution Nodes

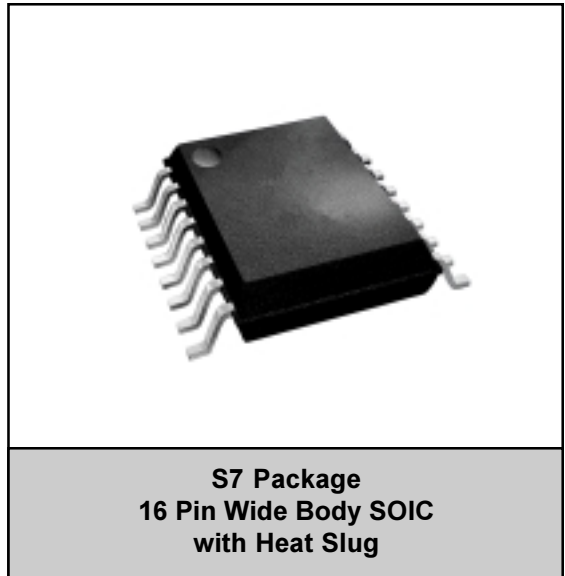

PRODUCT DESCRIPTION

The ACA2401 is a highly linear, monolithic GaAs RF amplifier that has been developed to replace, in new designs, standard CATV hybrid amplifiers. Offered in a convenient surface mount package, the MMIC consists of two pairs of parallel amplifiers that are optimized for exceptionally low distortion and noise

figure. A hybrid equivalent that provides flat gain response and excellent input and output return loss over the 40 to 870 MHz CATV downstream band is formed when one ACA2401 is cascaded between two appropriate transmission line baluns.

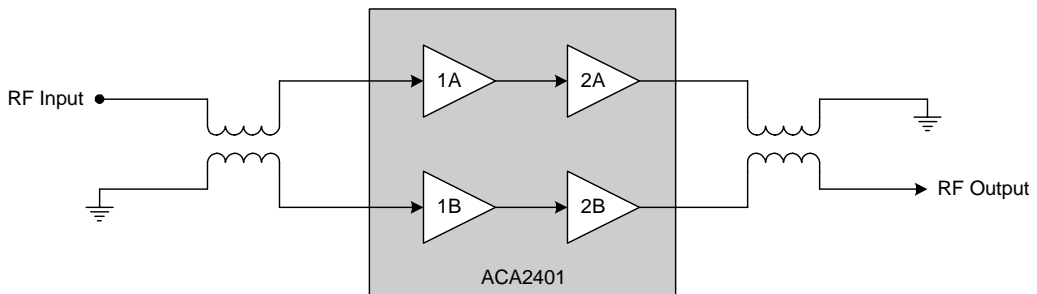

Figure 1: Hybrid Application Diagram

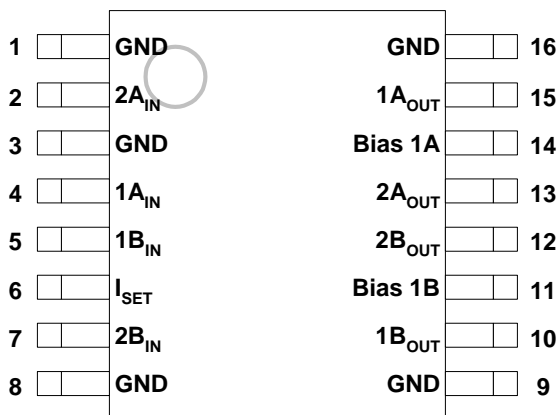

Figure 2: Pin Out

Table 1: Pin Description

PIN	NAME	DESCRIPTION	PIN	NAME	DESCRIPTION
1	GND	Ground	9	GND	Ground
2	2A _{IN}	Amplifier 2A Input	10	1B _{OUT}	Amplifier 1B Output
3	GND	Ground	11	Bias 1B	Bias for 1B Amplifier
4	1A _{IN}	Amplifier 1A Input	12	2B _{OUT}	Amplifier 2B Output and Supply
5	1B _{IN}	Amplifier 1B Input	13	2A _{OUT}	Amplifier 2A Output and Supply
6	I _{SET}	Current Adjust	14	Bias 1A	Bias for 1A Amplifier
7	2B _{IN}	Amplifier 2B Input	15	1A _{OUT}	Amplifier 1A Output
8	GND	Ground	16	GND	Ground

ELECTRICAL CHARACTERISTICS

Table 2: Absolute Minimum and Maximum Ratings

PARAMETER	MIN	MAX	UNIT
Supply (pins 12, 13)	0	+28	VDC
RF Power at Inputs (pins 4, 5)	-	+75	dBmV
Storage Temperature	-65	+150	°C
Soldering Temperature	-	+260	°C
Soldering Time	-	5.0	Sec

Stresses in excess of the absolute ratings may cause permanent damage. Functional operation is not implied under these conditions. Exposure to absolute ratings for extended periods of time may adversely affect reliability.

Notes:

1. Pins 2, 4, 5 and 7 should be AC-coupled. No external DC bias should be applied.
2. Pin 6 should be AC-grounded and/or pulled to ground through a resistor for current control. No external DC bias should be applied.
3. Pins 11 and 14 are bias feeds for input amplifiers 1A and 1B. No external DC bias should be applied.
4. Pins 10 and 15 receive DC bias directly from pins 11 and 14. No other external bias should be applied.

Table 3: Operating Ranges

PARAMETER	MIN	TYP	MAX	UNIT
Supply: V _{DD} (pins 12, 13)	-	+24	-	VDC
RF Frequency	40	-	870	MHz
Case Temperature	-40	-	+110	°C

The device may be operated safely over these conditions; however, parametric performance is guaranteed only over the conditions defined in the electrical specifications.

Table 4: AC and DC Electrical Specifications
(T_A = +25 °C, V_{DD} = +24 VDC)

PARAMETER	MIN	TYP	MAX	UNIT	COMMENTS
Gain @870 MHz ⁽¹⁾	20.8	21.3	21.8	dB	
Cable Equivalent Slope ⁽¹⁾	-	0	-	dB	
Gain Flatness ⁽¹⁾ @ 870 MHz	-	± 0.2	-	dB	
Noise Figure ⁽¹⁾	-	4.0	4.5	dB	
CTB ⁽¹⁾ 77 Channels ⁽²⁾ 110 Channels ⁽³⁾ 128 Channels ⁽⁴⁾	-	-70	-	dBc	
	-	-70	-68		
	-	-69	-		
	-	-69	-		
CSO ⁽¹⁾ 77 Channels ⁽²⁾ 110 Channels ⁽³⁾ 128 Channels ⁽⁴⁾	-	-72	-	dBc	
	-	-66	-64		
	-	-61	-		
	-	-61	-		
XMOD ⁽¹⁾ 77 Channels ⁽²⁾ 110 Channels ⁽³⁾ 128 Channels ⁽⁴⁾	-	-64	-	dBc	
	-	-64	-62		
	-	-62	-		
	-	-62	-		
Return Loss (Input/Output) ⁽¹⁾	18	22	-	dB	75 Ohm system
Supply Current	-	390	-	mA	
Thermal Resistance	-	-	3.8	°C/W	

Notes:

(1) Measured with baluns on the input and output of the device. See Figure 3 for test setup.

(2) Parts measured with 77 channels, +56 dBmV power, 13.5 dB tilt at 870 MHz.

(3) Parts measured with 110 channels, +52 dBmV power, 13.5 dB tilt at 870 MHz.

(4) Parts measured with 128 channels, +50 dBmV power, 13.5 dB tilt at 870 MHz.

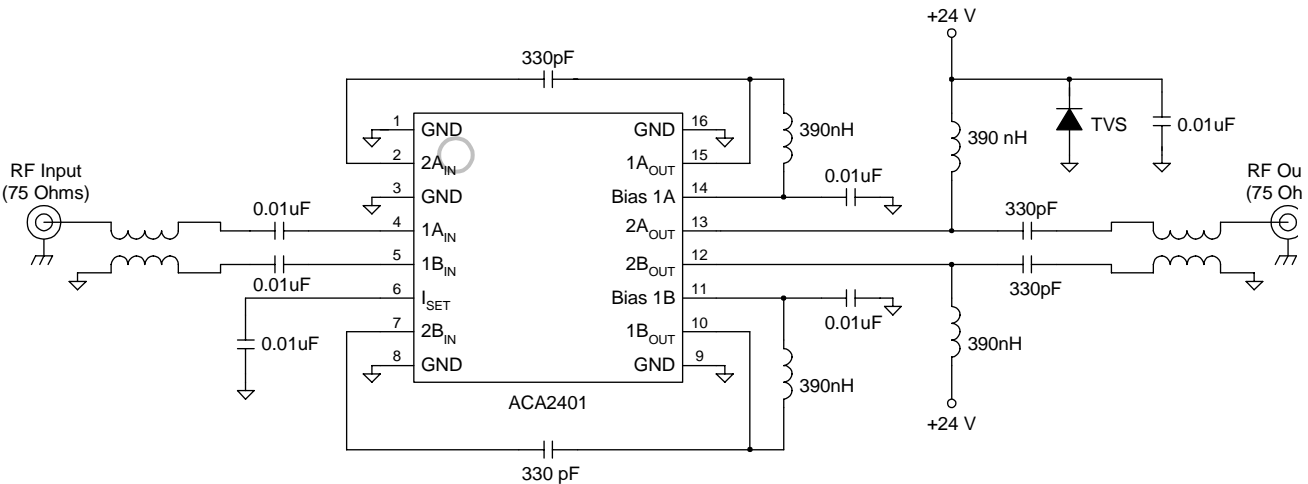

Figure 3: Test Circuit Schematic

PERFORMANCE DATA

Figure 4: Noise Figure vs. Frequency

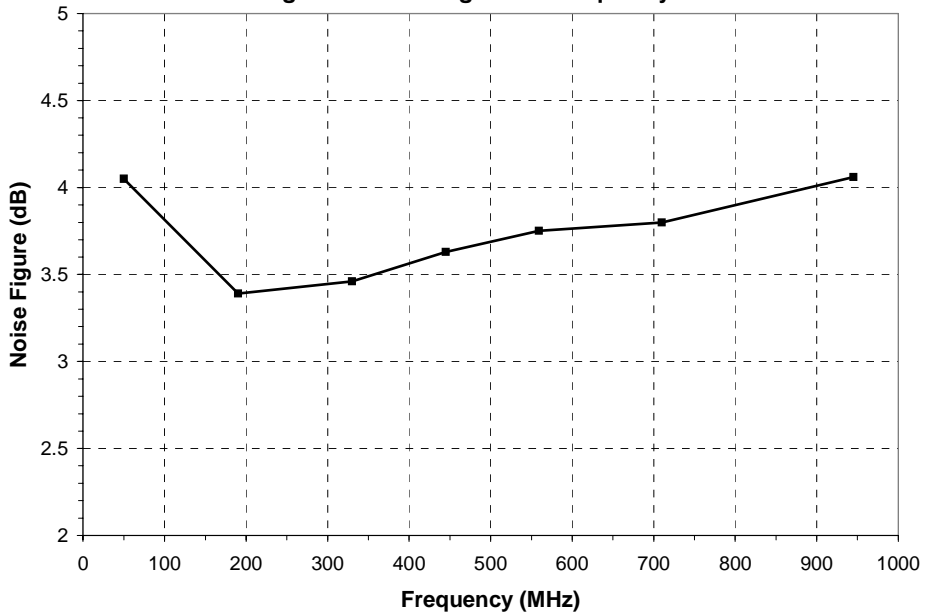

Figure 5: Gain (S21) vs. Frequency

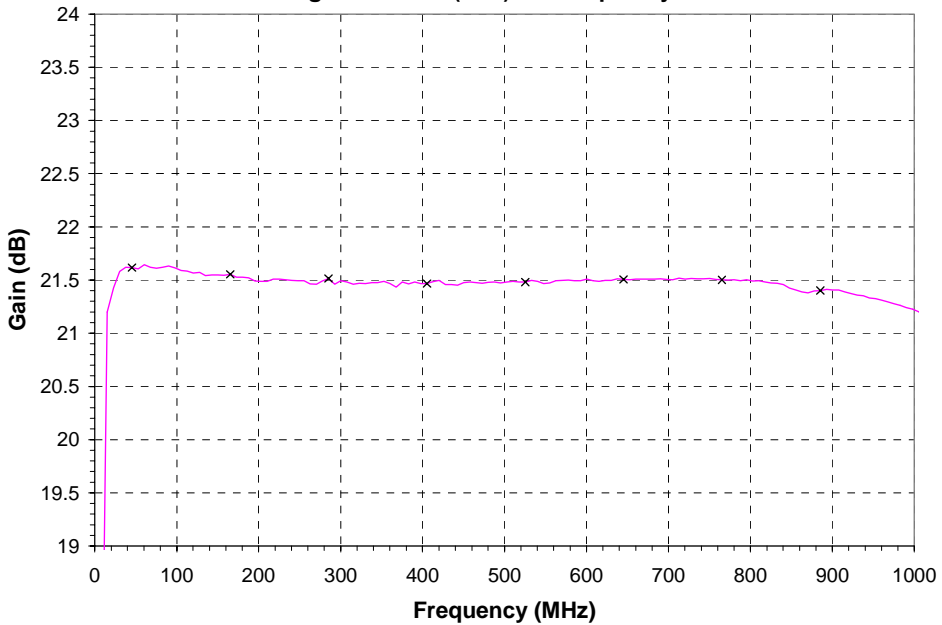

Figure 6: Input and Output Return Loss (S11 and S22) vs. Frequency

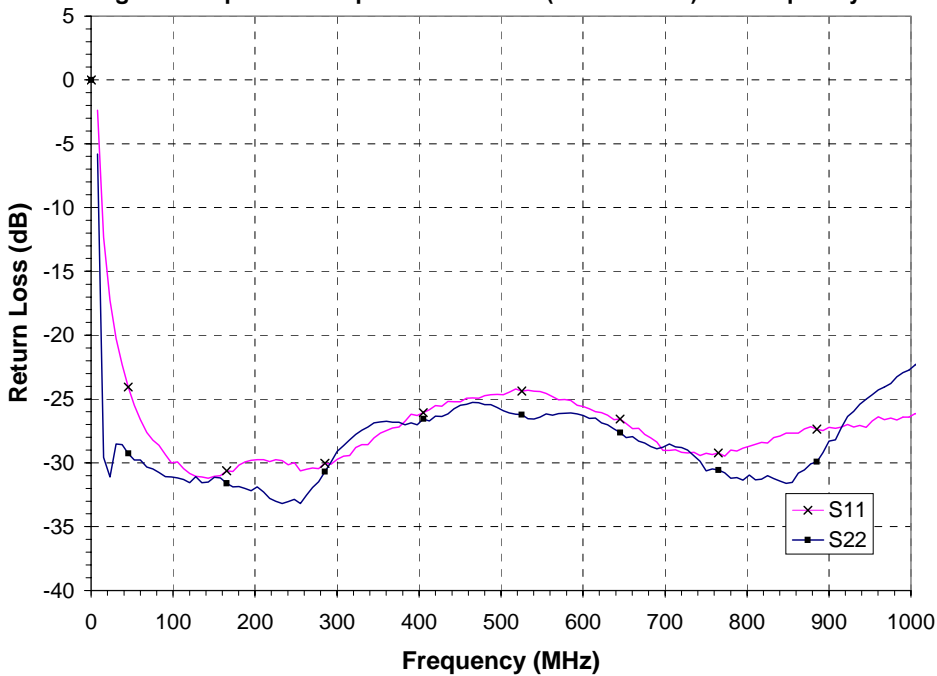

Figure 7: Isolation (S12) vs. Frequency

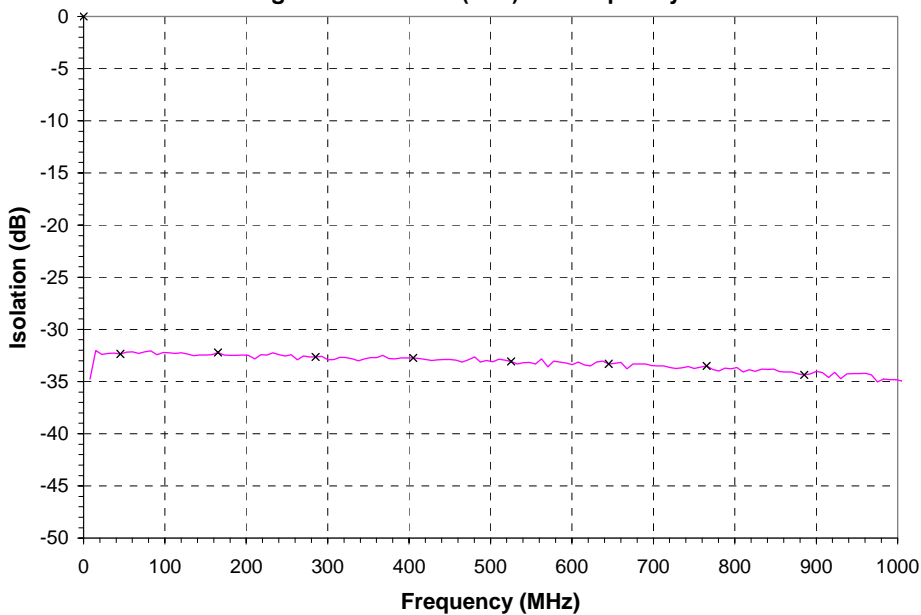

Figure 8: CTB vs. Frequency (110 channels, +52 dBmV power, 13.5 dB tilt at 870 MHz)

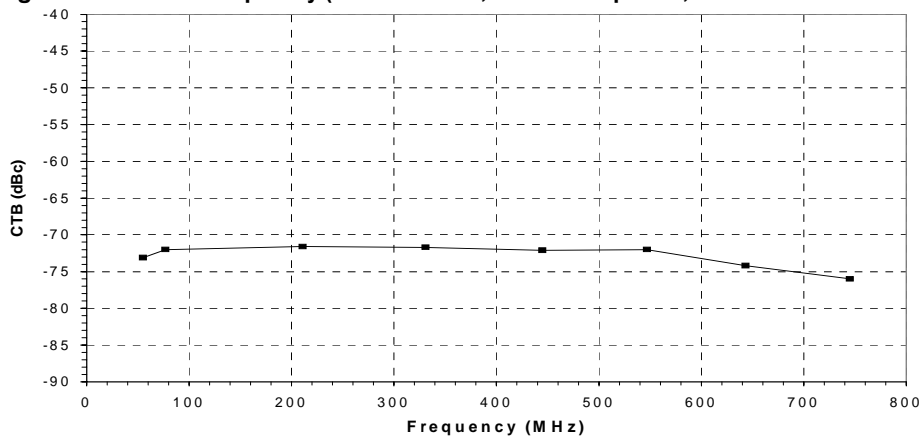

Figure 9: CSO vs. Frequency (110 channels, +52 dBmV power, 13.5 dB tilt at 870 MHz)

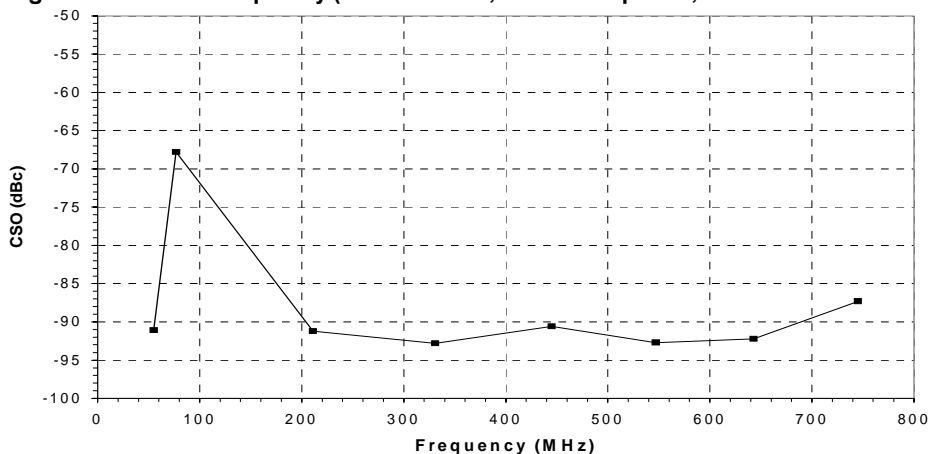

Figure 10: XMOD vs. Frequency (110 channels, +52 dBmV power, 13.5 dB tilt at 870 MHz)

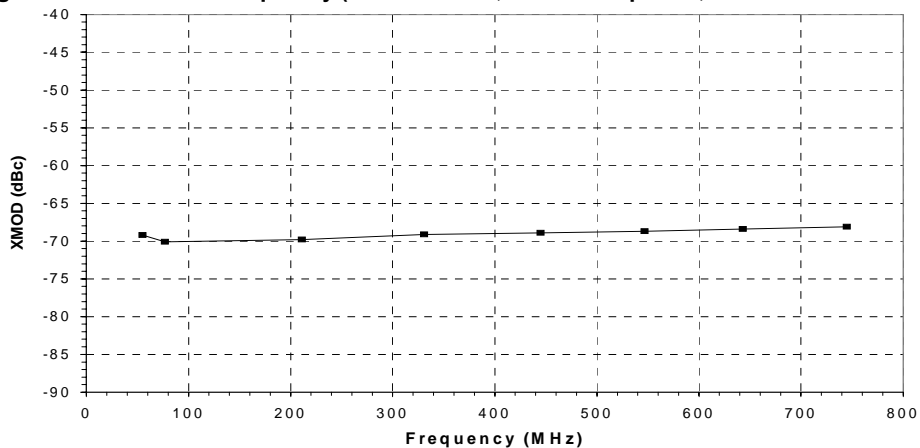

Figure 11: CTB vs. Frequency (77 channels, +56 dBmV power, 13.5 dB tilt at 870 MHz)

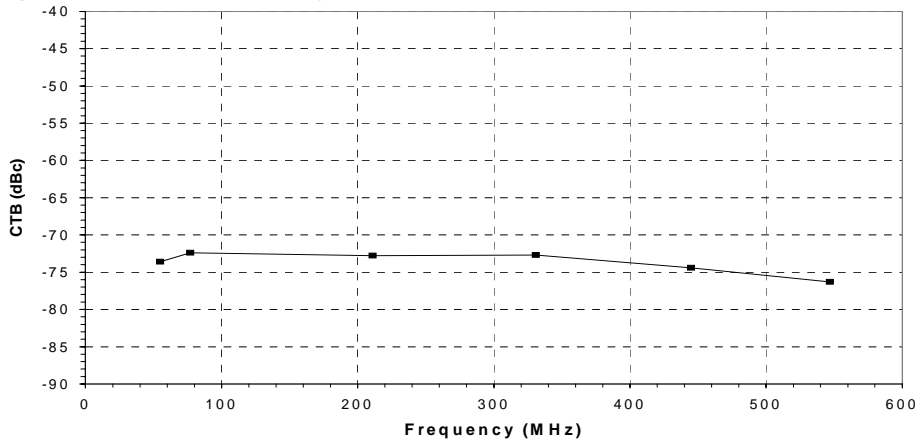

Figure 12: CSO vs. Frequency (77 channels, +56 dBmV power, 13.5 dB tilt at 870 MHz)

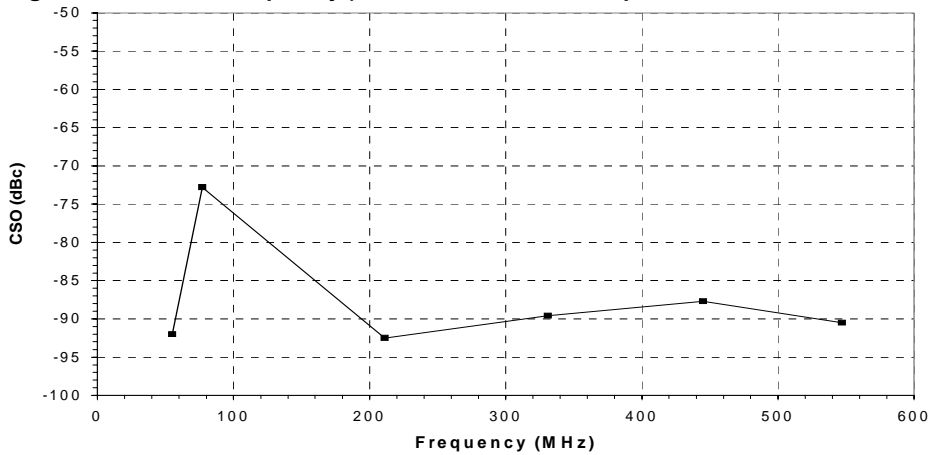

Figure 13: XMOD vs. Frequency (77 channels, +56 dBmV power, 13.5 dB tilt at 870 MHz)

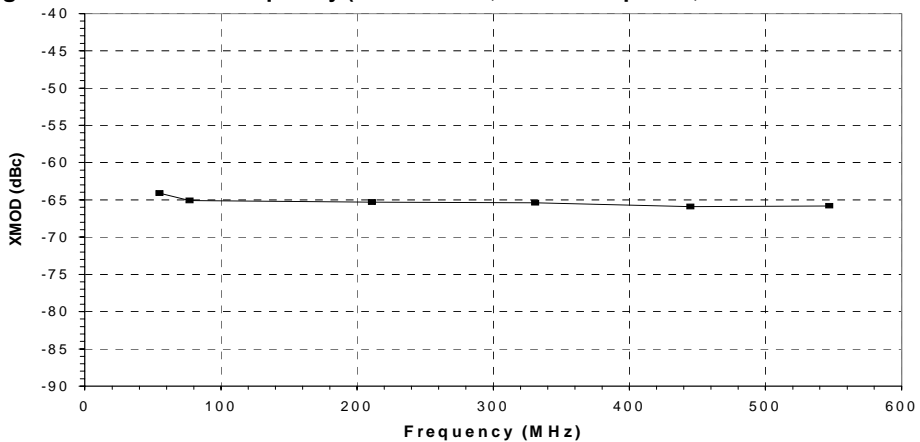

Table 5: Evaluation Board Parts List

REF	DESCRIPTION	QTY	VENDOR	VENDOR P/N
C1, C2, C3, C6, C7, C10, C14	0.01 uF CHIP CAP	7	MURATA	GRM39X7R103K50V
C4, C5, C8, C9	470 pF CHIP CAP	4	MURATA	GRM39X7R471K50V
C11	0.5 pF CHIP CAP	1	MURATA	GRM36COG0R5C50
C15	47 uF ELECT. CAP	1	DIGI-KEY CORP	P5275-ND
C12, C13, R1, R2, R3	NOT USED			
TVS	TVS 24 VOLT 600 WATT	1	DIGI-KEY CORP	SMBJ24ACCCT-ND
L1, L2, L3, L4	680 nH INDUCTOR	4	COILCRAFT	1008CS-681XKBC
CONNECTOR ⁽¹⁾	75 OHMS N MALE PANEL MOUNT	2	PASTERNAK ENTERPRISES	PE4504
T1, T2 ⁽²⁾ (BALUN)	Ferrite Core	2	FAIR-RITE	2843002702
	Wire		MWS WIRE IND.	T-2361429-20
	Printed Circuit Board ⁽³⁾	1	STANDARD PRINTED CIRC. INC	24VX1AC50
INDIUM	300 X 160 MILS	1	INDIUM CORP OF AMERICA	14996Y

Notes:

(1) N connector center pin should be approximately 80 mils in length.

(2) T1, T2 balun: 6.5 turns thru, as shown in Figure 16.

(3) Due to the power dissipation of this device, the printed circuit board should be mounted / attached to a heat sink.

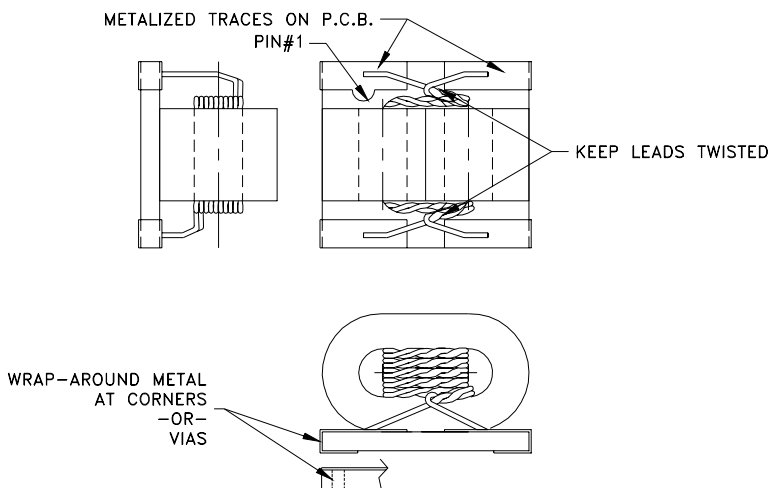
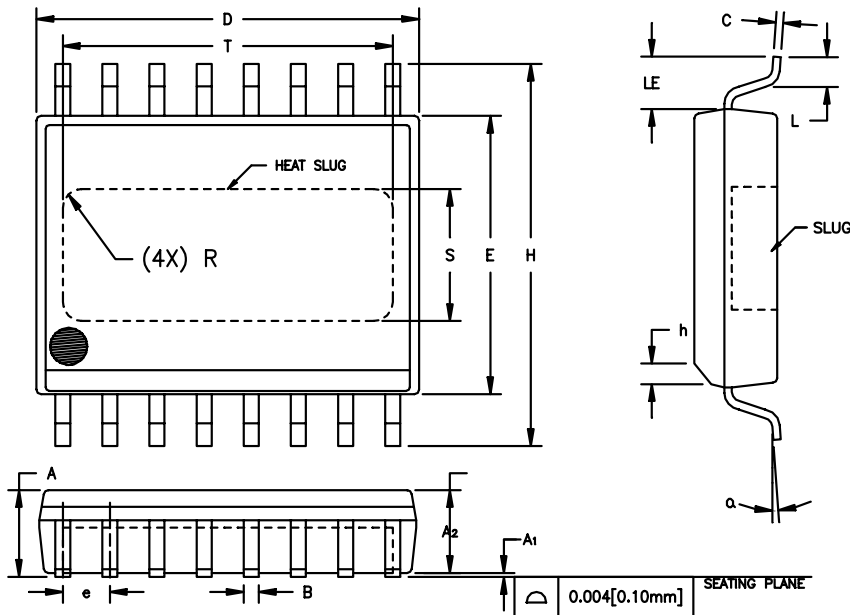

Figure 16: Balun Drawing

PACKAGE OUTLINE



DIM.	INCHES		MILLIMETERS		NOTE
	MIN.	MAX.	MIN.	MAX.	
A	0.087	0.098	2.21	2.49	
A ₁	0.000	0.004	0.00	0.10	6
A ₂	0.087	0.094	2.21	2.39	
B	0.013	0.019	0.33	0.48	
C	0.007	0.009	0.18	0.23	
D	0.398	0.412	10.11	10.46	2
E	0.290	0.300	7.37	7.62	3
e	0.050	BSC	1.27	BSC	4
H	0.394	0.418	10.01	10.62	
h	0.010	0.028	0.25	0.71	
L	0.024	0.040	0.61	1.02	
LE	0.052	—	1.32	—	
α	0°	8°	0°	8°	
S	0.120	0.140	3.05	3.56	5
T	0.330	0.350	8.38	8.89	5
R	REF.	0.015	REF.	0.38	5

NOTES:

1. CONTROLLING DIMENSION: INCHES
2. DIMENSION "D" DOES NOT INCLUDE MOLD FLASH, PROTRUSIONS OR GATE BURRS. MOLD FLASH, PROTRUSIONS AND GATE BURRS SHALL NOT EXCEED 0.006 [0.15mm] PER SIDE.
3. DIMENSION "E" DOES NOT INCLUDE INTER-LEAD FLASH OR PROTRUSIONS. INTER-LEAD FLASH AND PROTRUSIONS SHALL NOT EXCEED 0.010 [0.25mm] PER SIDE.
4. MAXIMUM LEAD TWIST/SKEW TO BE ±0.005 [0.13mm].
5. DIMENSIONS "S", "T" AND "R" INDICATE EXPOSED SLUG AREA.
6. STANDOFF HEIGHT (A₁) MEASURED FROM BOTTOM OF SLUG.

Figure 17: S7 Package Outline - 16 Pin Wide Body SOIC with Heat Slug

NOTES

NOTES

ORDERING INFORMATION

ORDER NUMBER	TEMPERATURE RANGE	PACKAGE DESCRIPTION	COMPONENT PACKAGING
ACA2401S7TR	-40 to 110 °C	16 Pin Wide Body SOIC with Heat Slug	1,500 piece tape and reel
ACA2401S7P0	-40 to 110 °C	16 Pin Wide Body SOIC with Heat Slug	Plastic tubes (25 pieces per tube)

**ANADIGICS, Inc.**

141 Mount Bethel Road
Warren, New Jersey 07059, U.S.A.

Tel: +1 (908) 668-5000

Fax: +1 (908) 668-5132

URL: <http://www.anadigics.com>

E-mail: Mktg@anadigics.com

IMPORTANT NOTICE

ANADIGICS, Inc. reserves the right to make changes to its products or to discontinue any product at any time without notice. The product specifications contained in Advanced Product Information sheets and Preliminary Data Sheets are subject to change prior to a product's formal introduction. Information in Data Sheets have been carefully checked and are assumed to be reliable; however, ANADIGICS assumes no responsibilities for inaccuracies. ANADIGICS strongly urges customers to verify that the information they are using is current before placing orders.

WARNING

ANADIGICS products are not intended for use in life support appliances, devices or systems. Use of an ANADIGICS product in any such application without written consent is prohibited.