



**APPLICATIONS FEATURES**

- OC-1 Receiver
- FITL
- Low Noise RF Amplifier

**FEATURES**

- **Single +5 Volt Supply**
- **Automatic Gain Control**
- **Excellent Sensitivity**
- **0 dBm Optical Overload**
- **Surface Mount Package**

**ELECTRICAL CHARACTERISTICS (1) ( $T_A = 25^\circ\text{C}$ ,  $V_{DD} = +5.0\text{V} \pm 10\%$ ,  $C_{DIODE} + C_{STRAY} = 0.5\text{ pF}$ , Det. Cathode to  $I_{IN}$ )**

PARAMETER	MIN	TYP	MAX	UNIT
Transresistance ( $R_I = \square, I_{dc} < 500\text{nA}$ )		55		$\text{K}\square$
Transresistance ( $R_I = 50\square$ ) <sup>(1)</sup>	15	28		$\text{K}\square$
Bandwidth -3dB	50	70		MHz
Input Resistance <sup>(2)</sup>		1500		$\square$
Output Resistance	30	50	60	$\square$
Input Offset Voltage	1.5	1.6	1.9	Volts
Output Offset Voltage		1.8		Volts
Offset Voltage Drift		1		$\text{mV}/^\circ\text{C}$
AGC Threshold ( $I_{IN}$ ) <sup>(3)</sup>	5	10		$\mu\text{A}$
AGC Time Constant <sup>(6)</sup>		16		$\square\text{sec}$
Optical Overload <sup>(4)</sup>	-3	0		dBm
Optical Sensitivity <sup>(7)</sup>		- 41		dBm
Input Noise Current <sup>(5)</sup>		7	12	nA RMS
Supply Current		30	45	mA
Operating Voltage Range	+ 4.5	+ 5.0	+ 6.0	Volts
Operating Temperature Range	- 40		85	$^\circ\text{C}$

- (1)  $f = 50\text{MHz}$
- (2) Measured with  $I_{IN}$  below AGC Threshold. During AGC, input impedance will decrease proportionally to  $I_{IN}$
- (3) Defined as the  $I_{IN}$  where Transresistance has decreased by 50%.
- (4) See note on "Indirect Measurement of Optical Overload".
- (5) See note on "Measurement of Input Referred Noise Current".
- (6)  $C_{AGC} = 56\text{ pF}$
- (7) Parameter is guaranteed (not tested) by design and characterization data @ 51Mb/s, assuming detector responsivity of 0.9

### ABSOLUTE MAXIMUM RATINGS

$V_{DD}$	7.0 V
$I_{IN}$	5 mA
$T_A$	Operating Temp. - 40 °C to 125 °C
$T_S$	Storage Temp. - 65 °C to 150 °C

### ATA00501S2C EQUIVALENT CIRCUIT

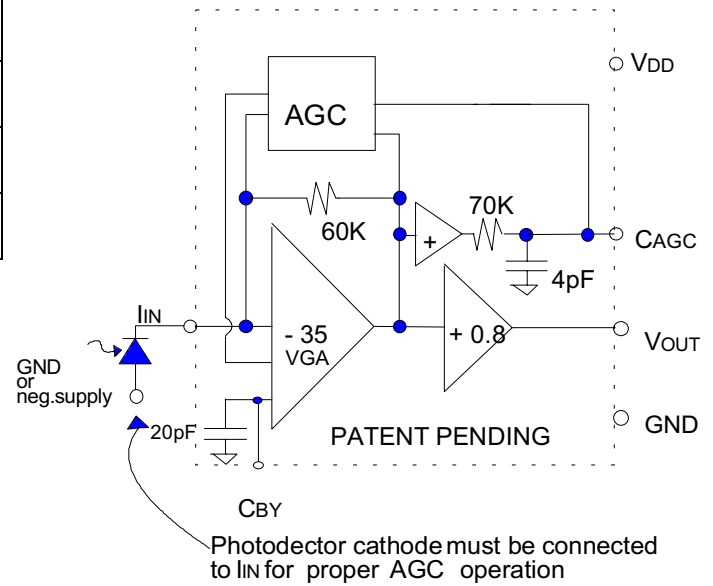

PIN No.	FUNCTION
1	NC
2	GND
3	$I_{IN}$
4	$C_{BY}$
5	GND
6	$C_{AGC}$
7	$V_{OUT}$
8	GND
9	NC
10	$V_{DD}$
11	GND
12	NC

### DIMENSIONS IN INCHES (MILLIMETERS)

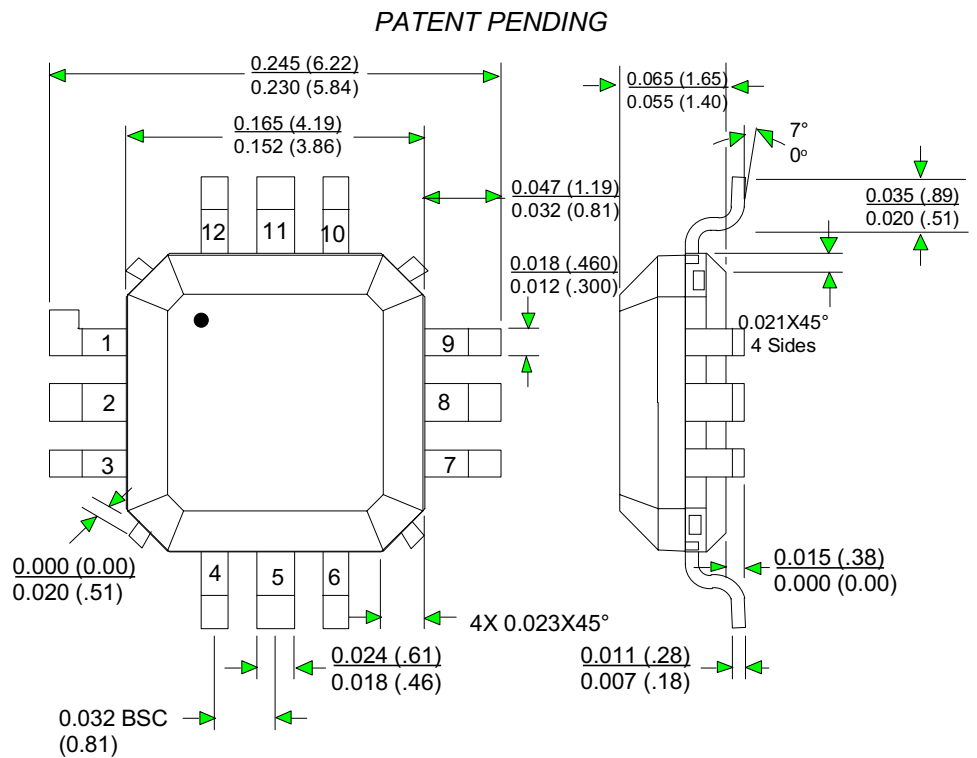

## TYPICAL EXTERNAL CIRCUIT

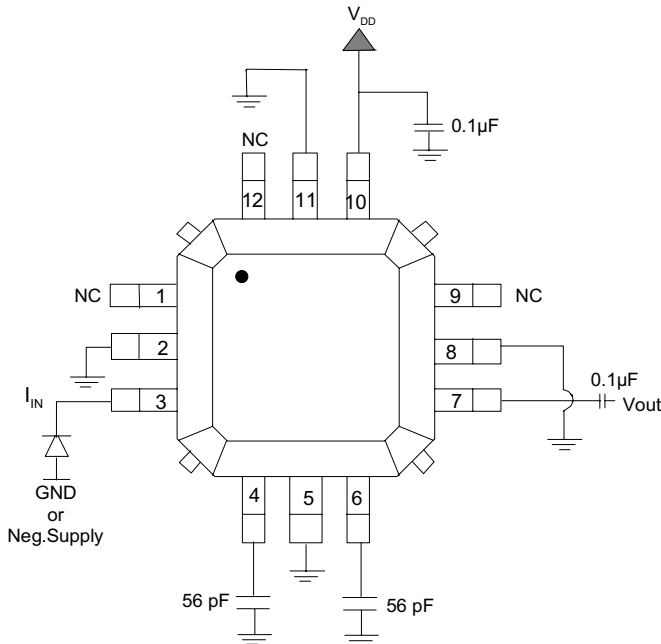

## POWER SUPPLIES AND GENERAL LAYOUT CONSIDERATIONS

The ATA00501S2C may be operated from a positive supply as low as + 4.5 V and as high as + 6.0 V. Below + 4.5 V, bandwidth, overload and sensitivity will degrade, while at + 6.0 V, bandwidth, overload and sensitivity improve (see "Bandwidth vs. Temperature" curves). Use of surface mount, low inductance power supply bypass capacitors ( $\geq 56\text{pF}$ ) are essential for good high frequency and low noise performance. The power supply bypass capacitors should be mounted on or connected to a good low inductance ground plane.

## GENERAL LAYOUT CONSIDERATIONS

Since the gain stages of the transimpedance amplifier have an open loop bandwidth in excess of 1.0 GHz, it is essential to maintain good high frequency layout practices. To prevent oscillations, a low inductance RF ground plane should be made available for power supply bypassing. Traces that can be made short should be made short, and the utmost care should be taken to maintain very low capacitance at the photodiode-TIA interface ( $I_{IN}$ ), excess capacitance at this node will cause a degradation in bandwidth and sensitivity (see Bandwidth vs.  $C_T$  curves).

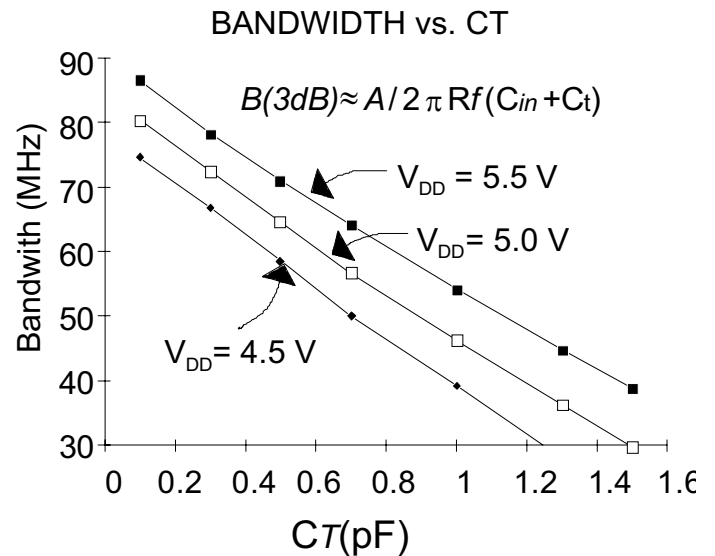
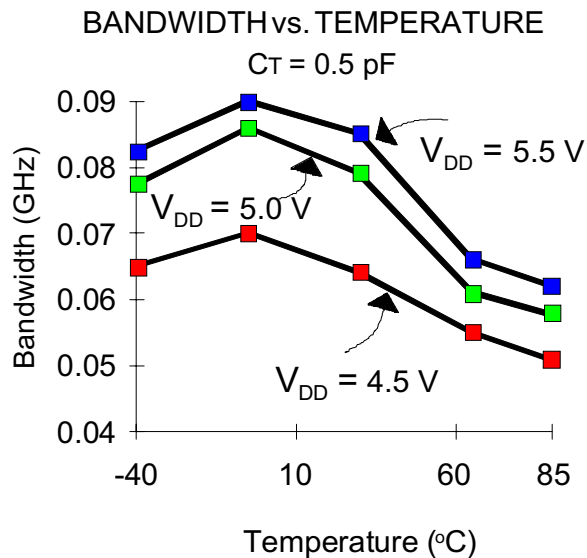

Note: All performance curves are typical @  $T_A = 25^\circ\text{C}$  unless otherwise noted.

## $I_{IN}$ CONNECTION

ATA00501S2C – Preliminary  
 AGC Transimpedance Amplifier  
 Sonet OC-1

The cathode of the photodetector should be connected to  $I_{IN}$  (Pin 3) for proper AGC operation. Although the detector may be used in the reverse direction for input currents not exceeding 10  $\mu$ A, the specifications for optical overload will not be met.

Transimpedance vs  $I_{IN}$

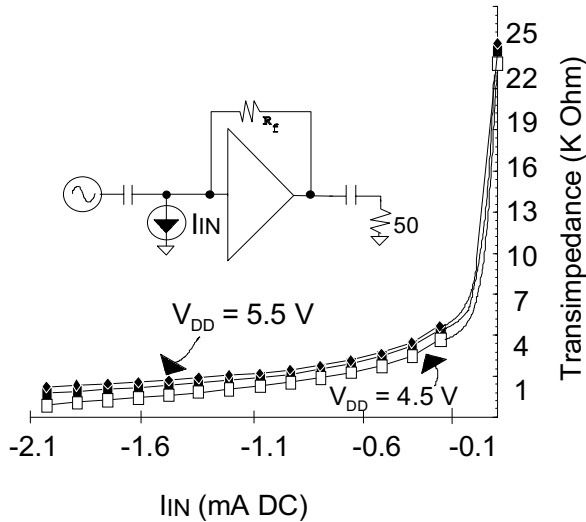

Bandwidth vs  $I_{IN}$

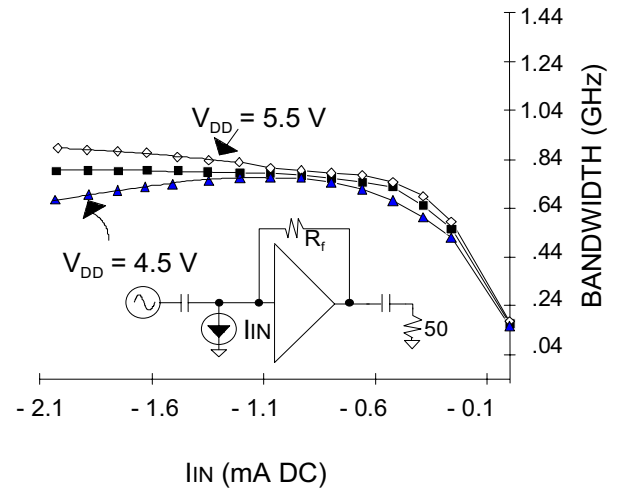

**$V_{OUT}$  CONNECTION**

$V_{OUT}$  (pin 7) should be connected via a coupling capacitor to the next stage of the receiver channel (filter or decision circuits), as the output buffers are not designed to drive a DC coupled 50 ohm load (this would require an output bias current of approximately 36 mA to maintain a quiescent 1.8 Volts across the output load). If  $V_{OUT}$  is connected to a high input impedance decision circuit (>500 ohms), then a coupling capacitor may not be required, although caution should be exercised since DC offsets of the photo detector/TIA combination may cause clipping of subsequent gain or decision circuits.

$V_{OUT}$  vs  $I_{IN}$

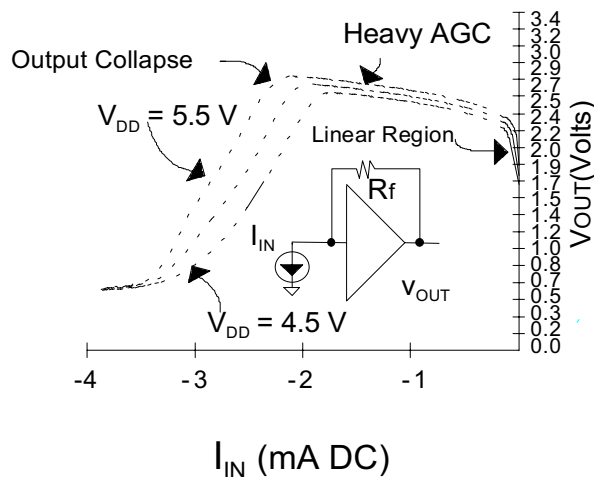

Input Offset Voltage vs. Temperature

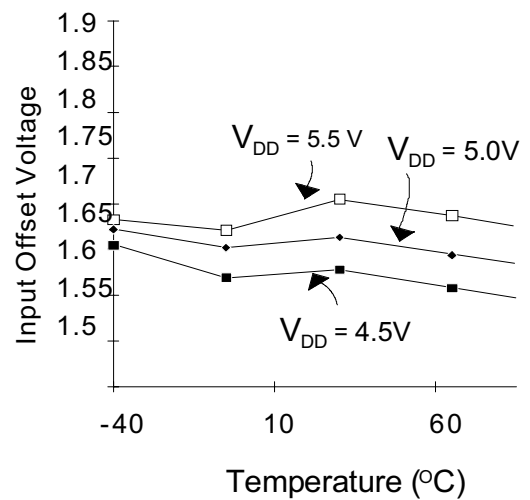

## SENSITIVITY AND BANDWIDTH

In order to guarantee sensitivity and bandwidth performance, the TIA is subjected to a comprehensive series of tests at the die sort level (100% testing at 25°C) to verify the DC parametric performance and the high frequency performance (i.e. adequate  $|S_{21}|$ ) of the amplifier. Acceptably high  $|S_{21}|$  of the internal gain stages will ensure low amplifier input capacitance and hence low input referred noise current. Transimpedance sensitivity and bandwidth are then guaranteed by design and correlation with RF and DC die sort test results.

## INDIRECT MEASUREMENT OF OPTICAL OVERLOAD

Optical overload can be defined as the maximum optical power above which the BER (bit error rate) increases beyond 1 error in  $10^{10}$  bits. The ATA00501S2C is 100% tested at die sort by a DC measurement which has excellent correlation with an PRBS optical overload measurement. The measurement consists of sinking a negative current (see  $V_{OUT}$  vs  $I_{IN}$  figure) from the TIA and determining the point of output voltage collapse. Also the input node virtual ground during "Heavy AGC" is checked to verify that the linearity (i.e. pulse width distortion) of the amplifier has not been compromised.

## MEASUREMENT OF INPUT REFERRED NOISE CURRENT

The "Input Noise Current" is directly related to sensitivity. It can be defined as the output noise voltage ( $V_{OUT}$ ), with no input signal, (including a 30 MHz lowpass filter at the output of the TIA) divided by the AC transresistance.

## AGC CAPACITOR

It is important to select an external AGC capacitor of high quality and appropriate size. The ATA00501S2C has an on-chip 70 KW resistor with a shunt 4 pF capacitor to ground. Without external capacitance the chip will provide an AGC time constant of 280 nS. For the best performance in a typical 51Mb/s SONET receiver, a minimum AGC capacitor of 56pF is recommended. This will provide the minimum amount of protection against pattern sensitivity and pulse width distortion on repetitive data sequences during high average optical power conditions. The AGC function of the IC can be disabled by grounding pin 6,  $C_{AGC}$ . Conservative design practices should be followed when selecting an AGC capacitor, since unit to unit variability of the internal time constant and various data conditions can lead to data errors if the chosen value is too small.

## PHASE RESPONSE

At frequencies below the 3dB bandwidth of the device, the transimpedance phase response is characteristic of a single pole transfer function (as shown in the Phase vs Frequency curve). The output impedance is essentially resistive up to 1000 MHz.

INPUT REFERRED NOISE SPECTRAL DENSITY

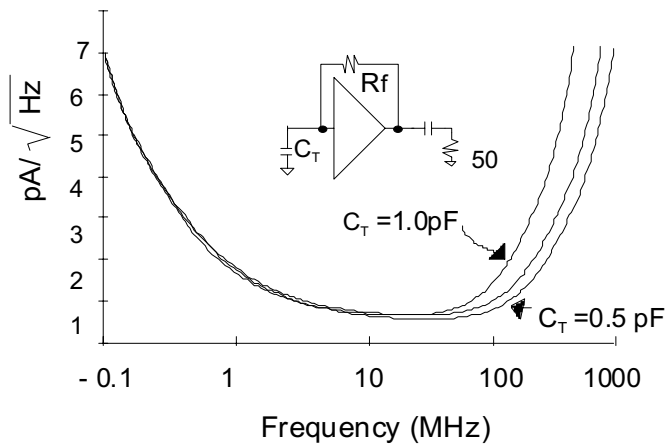

INPUT REFERRAL NOISE vs. TEMPERATURE

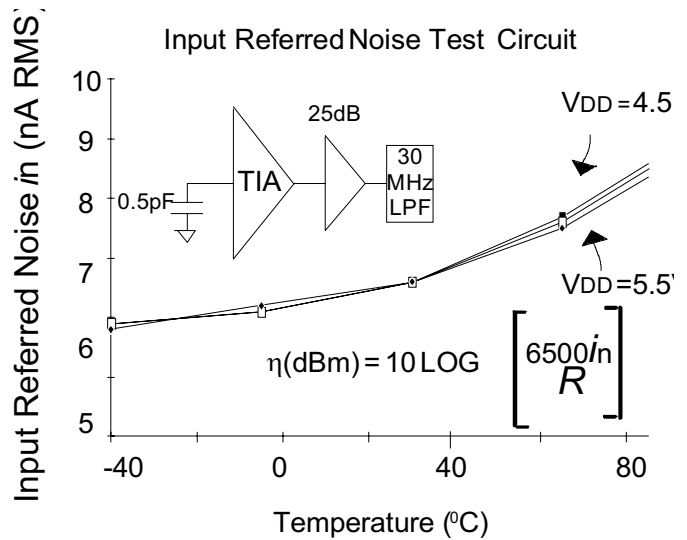

Phase ( $I_{IN}$  to  $V_{OUT}$ )

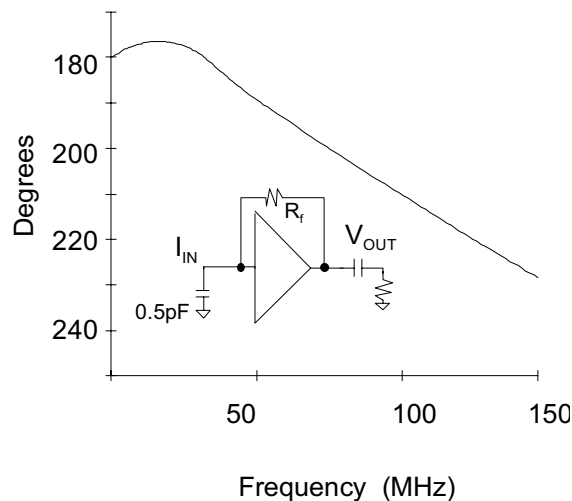

**ANADIGICS, Inc.**  
 35 Technology Drive  
 Warren, New Jersey 07059  
 Tel: (908) 668-5000 Fax: (908) 668-5132  
[Mktg@anadigics.com](mailto:Mktg@anadigics.com)

**IMPORTANT NOTICE**

ANADIGICS, Inc. reserves the right to make changes to its products or discontinue any product at any time without notice. The Advanced Product data sheets and product specifications contained in this data sheet are subject to change prior to a products formal introduction. The information in this data sheet has been carefully checked and is assumed to be reliable. However, ANADIGICS assumes no responsibility for inaccuracies. ANADIGICS strongly urges customers to verify that the information they are using is current before placing orders.

**WARNING**

ANADIGICS products are not intended for use in life support appliances, devices, or systems. Use of an ANADIGICS product in any such application without written consent is prohibited.