

# MDS Medical AC-DC Adapter

## 12V 60W / MDS-060AAS12 BA



# 060AAS

### Highlights & Features

- Compliant to IEC 60601-1 3rd edition
- IT and medical safety approvals
- Low earth leakage current (<0.1mA)
- Overload, over voltage, over temperature and short circuit protections
- Risk management report available
- Energy Star Compliance (Level V)
- 2 x MOPP(means of patient protection)

### Safety Standards



CB Certified for worldwide use

**Model Number:** MDS-060AAS12 BA  
**Unit Weight:** 0.36 kg  
**Dimensions (W x L x H):** 62.0x135.0x34.1 mm  
 2.4x5.3x1.3 in

### General Description

The MDS series of external power supply comes with universal AC input at 90Vac to 275Vac. Other features include low earth leakage, risk management report available and the electric shock protection comply with 2 x MOPP. The MDS series is certified for EMC standards according to EN 55011 for industrial, scientific and medical (ISM) radio-frequency equipment and EN 55022 for Information Technology Equipment (ITE) radio-frequency equipment. In addition, only recognized Japanese capacitors are used.

The MDS series come with both medical and ITE safety approvals including UL/CSA/CCC/CE and CB certification and are fully compliant with RoHS Directive 2011/65/EU for environmental protection.

### Model Information

Medical AC-DC Adapter

Model Number	Input Voltage Range	Output Voltage	Output Current
MDS-060AAS12 BA	90-275Vac	12Vdc	5A

### Model Numbering

MDS	060	A	A	S	12	B	A
Delta Medical power Supply	Max wattage in the product Series. Maybe lower at some voltage. 060 → 60W 120 → 120W 1K2 → 1,200W	Family Code A ~ Z	Product Type A: Adapter	Output Code S: Single Output 2: Dual Output 3: Triple Output 4: Four Output 5: More than Five Output	Output Voltage Single Output: - 03 for 3.3V - 05 for 5V - 12 for 12V Multiple Output: Serial Number 00 to 99	Input Connector code B: Socket C14 / 3 Pin D: Socket C6 / 3 Pin	Output Connector code A: 4 pin DIN/1200mm B: 4 pin DIN/1800mm E = barrel type 5.5*2.5, L=10mm/1200mm F = barrel type 5.5*2.5, L=10mm/1800mm J = barrel type 5.5*1.7, L=10mm/1200mm K = barrel type 5.5*1.7, L=10mm/1800mm

# MDS Medical AC-DC Adapter

## 12V 60W / MDS-060AAS12 BA

### Specifications

#### Input Ratings / Characteristics

Nominal Input Voltage	100-250Vac
Input Voltage Range	90-275Vac
Nominal Input Frequency	50-60Hz
Input Frequency Range	47-63Hz
Input Current (max)	1.5A @ 115Vac, 0.75A @ 230Vac
Efficiency (typ.)	88%, Reference Fig.1
Standby Power (max)	0.3W
Inrush Current (typ.)	50A @ 115Vac, 100A @ 230Vac
Earth Leakage Current (max)	0.1mA @ 275Vac NC <sup>1)</sup> , 0.3mA @ 275Vac SFC <sup>2)</sup>

1) NC: normal condition

2) SFC: single fault condition

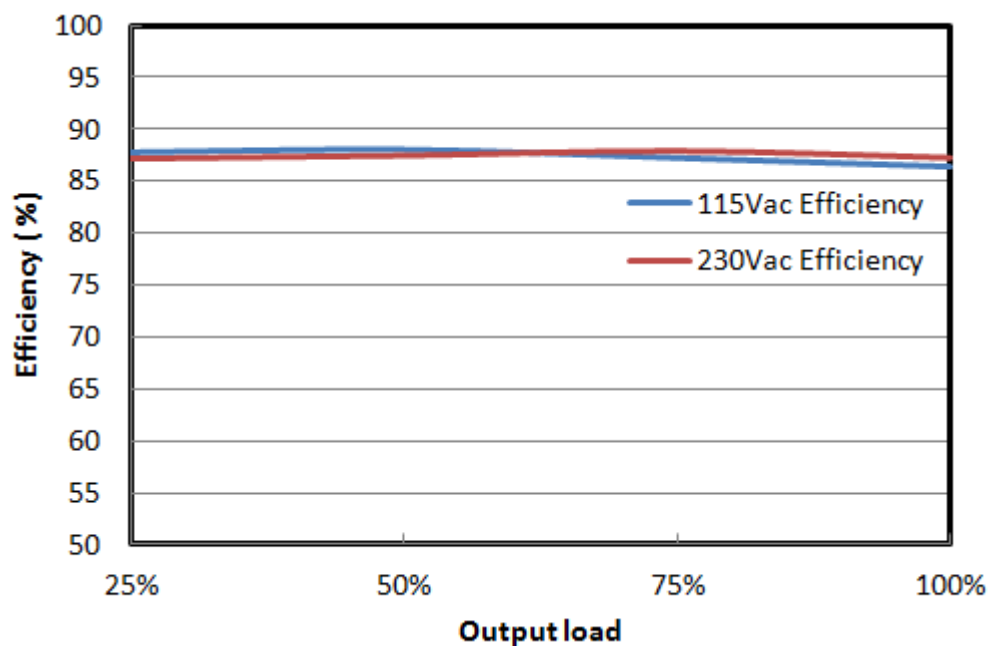

Fig.1 Efficiency versus output load

#### Output Ratings / Characteristics

Nominal Output Voltage	12Vdc
Output Voltage Tolerance	± 5%
Output Current	5A
Output Power	60W
Line Regulation (max)	±0.5%
Load Regulation (max)	±5%
Ripple & Noise (typ.)	67mV pk-pk @ Full load, Reference Fig. 2
Start-up Time (max)	3000ms @ 115Vac
Hold-up Time (min)	10ms @ 115Vac
Dynamic Response (Overshoot & Undershoot O/P Voltage)	± 5% @ 50-100% load

# MDS Medical AC-DC Adapter

## 12V 60W / MDS-060AAS12 BA

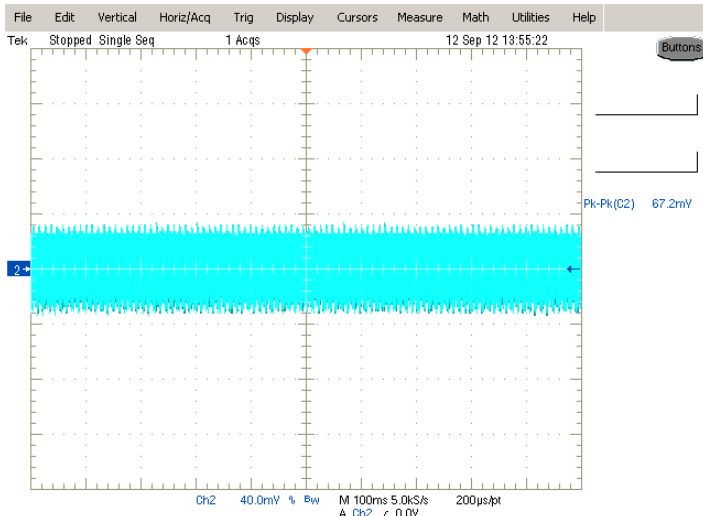

(a) 115V

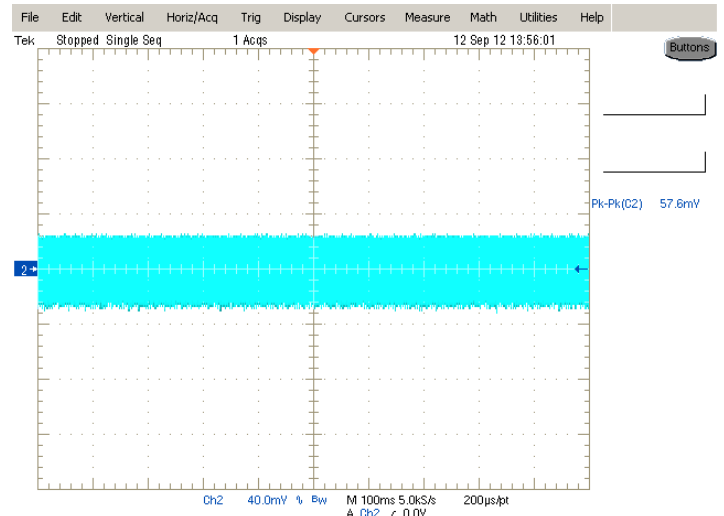

(b) 230V

Fig. 2 Ripple & Noise example 20MHz BW

### Ripple & Noise measurement circuit

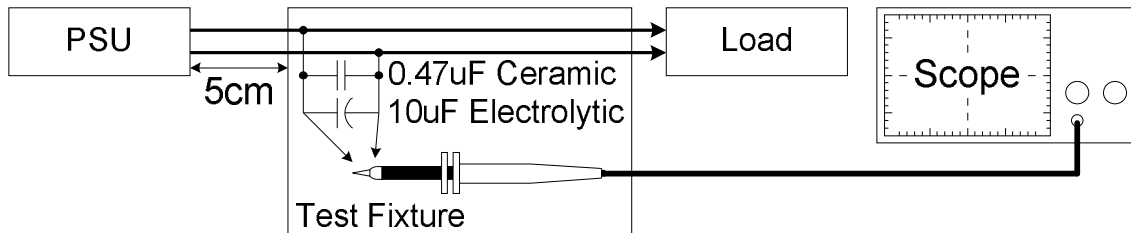

### Mechanical

Case Chassis	PC
Case Cover	PC
Dimensions(W x L x H)	62.0 x 135.0 x 34.1 mm(2.4x5.3x1.3 in)
Unit Weight	0.36 kg
Indicator	NA
Terminal	Input C14 socket
	Output 4 Pin Din

### Environment

Surrounding Air Temperature	Operating	0°C to +40°C
	Storage	-40°C to +85°C
Operating Humidity		10-95% RH (Non-Condensing)
Operating Altitude		3,000 meters
Shock Test (Non-Operating)		50G, 11ms, 3 shocks for each direction
Vibration (Operating)		5-500Hz, 2.09Grms, 20 minute for each three axis

# MDS Medical AC-DC Adapter

## 12V 60W / MDS-060AAS12 BA

### Protections

Overvoltage (max.)	150%, Latch Mode
Over load / Over current (max.)	180% of rated load current, Hiccup Mode, (Non-Latching, Auto-Recovery)
Over Temperature	Hiccup Mode, (Non-Latching, Auto-Recovery)
Short Circuit	Hiccup Mode, (Non-Latching, Auto-Recovery)
Degree of Protection	IP40
Protection Against Shock	Class I

### Reliability Data

MTBF (typ.)	1218 kHrs based on Telecordia SR-332
-------------	--------------------------------------

### Safety Standards / Directives

Medical Safety	IEC60601-1: (Ed.3,2005), EN0601-1:2006, CAN/CSA-C22.2 No. 60601-1:08, ANSI/AAMI ES60601-1: (Ed.3,2005)	
ITE Safety	IEC60950-1 (Ed.2,2005), GB4943.1-2011, GB9254-2008, GB17625.1-2003	
CE	MDD Directive 93/42/EEC	
Material and Parts	RoHS Directive 2011/65/EU Compliant	
Galvanic Isolation	Input to Output	4000 Vac
	Input to Ground	1500 Vac
	Output to Ground	500 Vac

# MDS Medical AC-DC Adapter

## 12V 60W / MDS-060AAS12 BA

### EMC

EMC / Emissions	EN55011, EN55022, FCC Title 47: Class B	
Immunity to		
Voltage Flicker	IEC61000-3-3	
Electrostatic Discharge	IEC61000-4-2	Level 3 Criteria A <sup>1)</sup> Air Discharge: 8kV Contact Discharge: 6kV
Radiated Field	IEC61000-4-3	Level 2 Criteria A <sup>1)</sup> 80MHz-1GHz, 3V/M with 1kHz tone / 80% modulation
Electrical Fast Transient / Burst	IEC61000-4-4	Level 3 Criteria A <sup>1)</sup> 2kV
Surge	IEC61000-4-5	Level 3 Criteria A <sup>1)</sup> Common Mode <sup>2)</sup> : 2kV Differential Mode <sup>3)</sup> : 1kV
Conducted	IEC61000-4-6	Level 2 Criteria A <sup>1)</sup> 150kHz-80MHz, 3Vrms
Power Frequency Magnetic Fields	IEC61000-4-8	Criteria A <sup>1)</sup> Magnetic field strength 3A/Meter
Voltage Dips	IEC61000-4-11	30% 10ms Criteria A ; 60% 100ms and 100% 5000ms Criteria B

1) Criteria A: Normal performance within the specification limits

2) Asymmetrical: Common mode (Line to earth)

3) Symmetrical: Differential mode (Line to line)

### Block Diagram

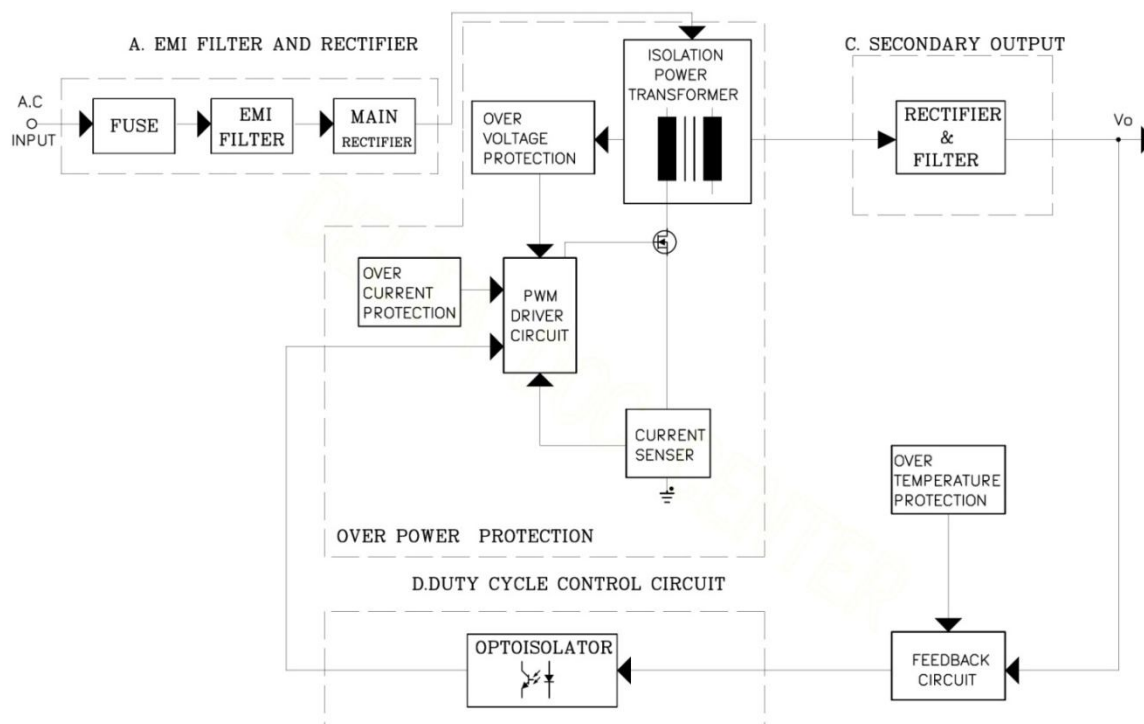

# MDS Medical AC-DC Adapter

## 12V 60W / MDS-060AAS12 BA

### Dimensions

W x L x H: 62.0 x 135 x 34.1 mm

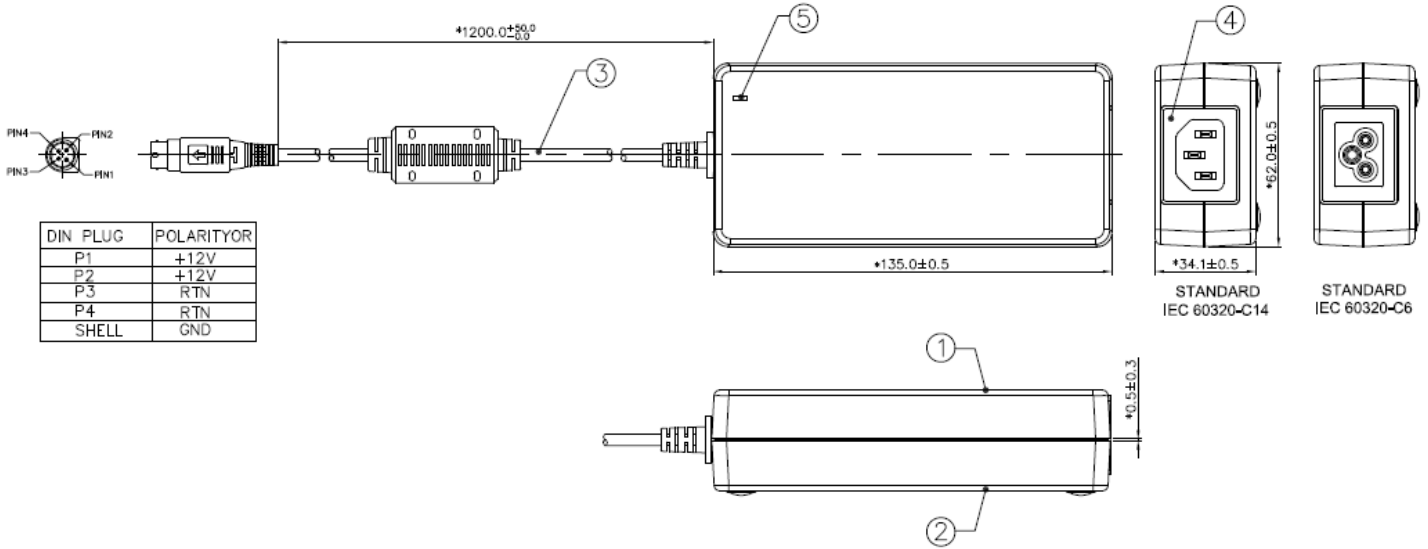

### Notes

— Dimensions are in mm

Item	Device Description
1	Cover
2	Chassis
3	Power Cord
4	Socket
5	Lens

# MDS Medical AC-DC Adapter

## 12V 60W / MDS-060AAS12 BA

### Functions

#### Start-up Time

The time required for the output voltage to reach 90% of its set value, after the input voltage is applied.

#### Rise Time

The time required for the output voltage to change from 10% to 90% of its set value.

#### Hold-up Time

Hold up time is the time when the AC input collapses and output voltage retains regulation for a certain period of time. The time required for the output to reach 95% of its set value, after the input voltage is removed.

#### ■ Graph illustrating the Start-up Time, Rise Time, and Hold-up Time

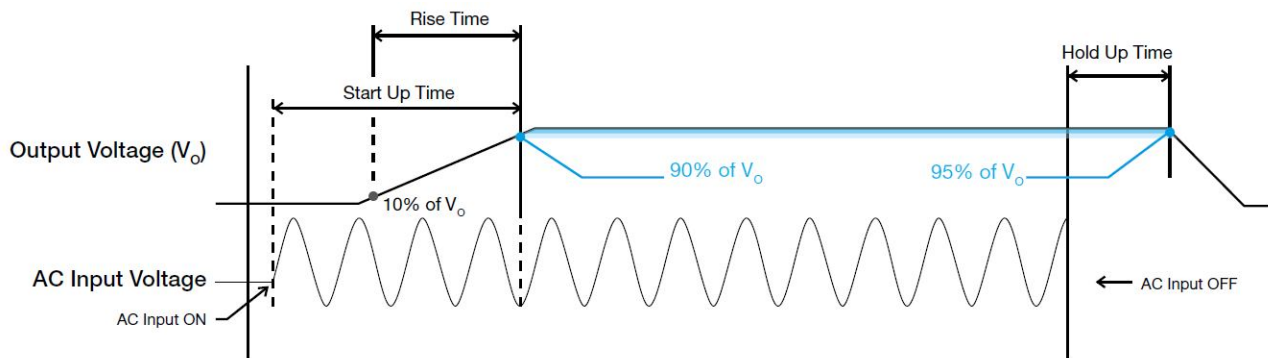

# MDS Medical AC-DC Adapter

## 12V 60W / MDS-060AAS12 BA

### Dynamic Response

The power supply output voltage will remain within  $\pm 5\%$  of its steady state value, when subjected to a dynamic load 50 to 100% of its rated current.

■ 50 to 100% Load

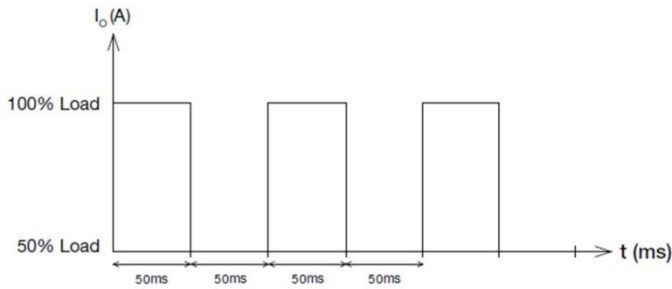

### Inrush Current

Inrush current is the peak, instantaneous, input current measured and, occurs when the input voltage is first applied. For AC input voltages, the maximum peak value of inrush current will occur during the first half cycle of the applied AC voltage. This peak value decreases exponentially during subsequent cycles of AC voltage.

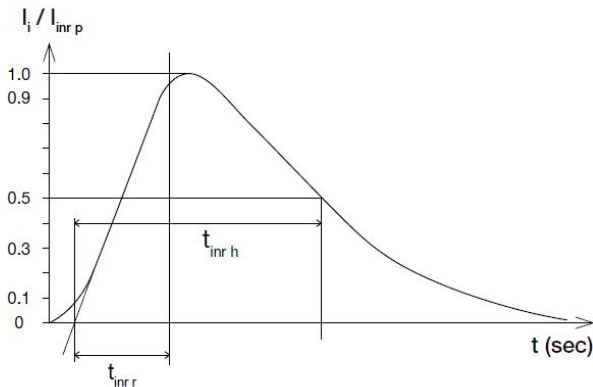

### Overvoltage Protection

The power supply's overvoltage circuit will be activated when its internal feedback circuit fails. The output voltage shall not exceed its specifications defined on Page 4 under "Protections". Power supply will latch off, and require removal/re-application of input AC voltage in order to restart.

### Short Circuit Protection

The power supply's output OLP/OCP function also provides protection against short circuits. When a short circuit is applied, the output current will operate in "Hiccup mode", as shown in the illustration in the OLP/OCP section on this page. The power supply will return to normal operation after the short circuit is removed.

### Overload & Over current Protections

The power supply's Overload (OLP) and Over current (OCP) Protections will be activated when output current under 200% of  $I_o$  (Max load). In such occurrence, the  $V_o$  will start to droop and once the power supply has reached its maximum power limit, the protection is activated and the power supply will go into "Hiccup mode" (Auto-Recovery). The power supply will recover once the fault condition of the OLP and OCP is removed and  $I_o$  is back within the specifications.

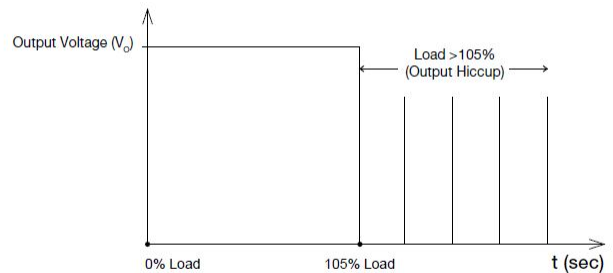

Additionally, if the  $I_o$  is  $<105\%$  but  $>100\%$  for a prolong period of time (depending on the load), the Over Temperature Protection (OTP) will be activated due to high temperature on critical components. The power supply will then go into latch mode until the fault is removed and the mains is reapplied.

### Over Temperature Protection

As mentioned above, the power supply also has Over Temperature Protection (OTP). This is activated when the overload condition persists for an extended duration and the output current is below the overload trigger point but  $>100\%$  load. In the event of a higher operating condition at 100% load, the power supply will run into OTP when the surrounding air temperature is higher than the operating temperature. When activated, the output voltage will go into hiccup mode until the main is reapplied and the surrounding air temperature drops to its normal operating temperature.



# MDS Medical AC-DC Adapter

## 12V 60W / MDS-060AAS12 BA

### Certificate



All Delta Medical Power products conform to the European directive 2011/65/EU. RoHS is the abbreviation for "Restriction of the use of certain hazardous substances"



Delta has been certified as meeting the requirement of ISO 13485: 2003 and EN ISO 13485: 2012 for the design and manufacture of switching power supply and adaptor for medical device.



In addition to a UL Total Certification Program (TCP) approved client laboratory for IEC62368-1. Delta also has participated UL Client Test Data Program (CTDP) for IEC 60601



Energy star level V compliance

# Mouser Electronics

Authorized Distributor

Click to View Pricing, Inventory, Delivery & Lifecycle Information:

Delta:

[MDS-060AAS12 BA](#)