



austriamicrosystems AG

is now

ams AG

The technical content of this austriamicrosystems datasheet is still valid.

Contact information:

Headquarters:

ams AG

Tobelbaderstrasse 30

8141 Unterpremstaetten, Austria

Tel: +43 (0) 3136 500 0

e-Mail: ams_sales@ams.com

Please visit our website at www.ams.com

AS1710/AS1712

High-Output-Drive, 10MHz, 10V/μs, Rail-to-Rail I/O Op Amps with Shutdown

1 General Description

The AS1710/AS1712 are low-offset, high-output CMOS op-amps that deliver 200mA of peak output current from a single supply (2.7V to 5.5V).

These devices were specifically designed to drive typical headset levels (32Ω), as well as bias RF power amplifiers for wireless handset applications.

The devices are available as the standard products shown in Table 1. See also [Ordering Information on page 18](#).

Table 1. Standard Products

Model	Description	Package
AS1710A	Single Op Amp with Shutdown	SC70-6
AS1710B	Single Op Amp	SC70-5
AS1712A	Quad Op Amp with Shutdown	TQFN-16 (3x3mm)

These rail-to-rail I/O, wide-bandwidth amplifiers exhibit a high slew rate of 10V/μs and a gain-bandwidth product of 10MHz.

The integrated shutdown feature (not included in B versions) drives the output low.

These devices operate over the entire industrial temperature range (-40°C to +85°C).

2 Key Features

- Constant Output Drive Capability: 50mA
- Rail-to-Rail Input and Output
- Supply Current: 1.6mA
- Single-Supply Operation: 2.7V to 5.5V
- Gain-Bandwidth Product: 10MHz
- High Slew Rate: 10V/μs
- Voltage Gain: 100dB (R_{LOAD} = 100kΩ)
- Power-Supply Rejection Ratio: -85dB
- No Phase Reversal for Overdriven Inputs
- Unity-Gain Stable for Capacitive Loads: Up to 100pF
- Shutdown Mode (AS1710A) Current: 1nA typ
- Package Types:
 - SC70-6
 - SC70-5
 - TQFN-16 (3x3mm)

3 Applications

The devices are ideal for portable/battery-powered audio applications, portable headphone speaker drivers (32Ω), hands-free mobile phone kits, TFT panels, sound ports/cards, set-top boxes, biasing controls, DAC converter buffers, transformer/line drivers, motor drivers, and any other battery-operated audio device.

Figure 1. AS1710 - Typical Application

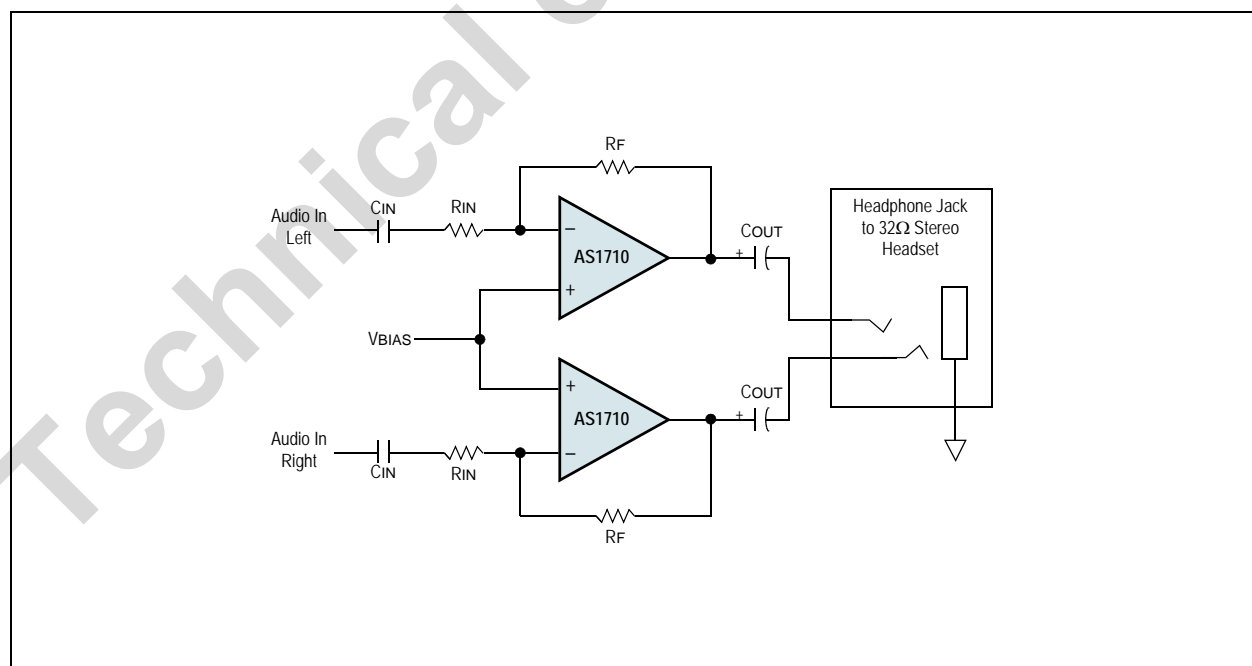

4 Pin Assignments

Figure 2. Pin Assignments (Top View)

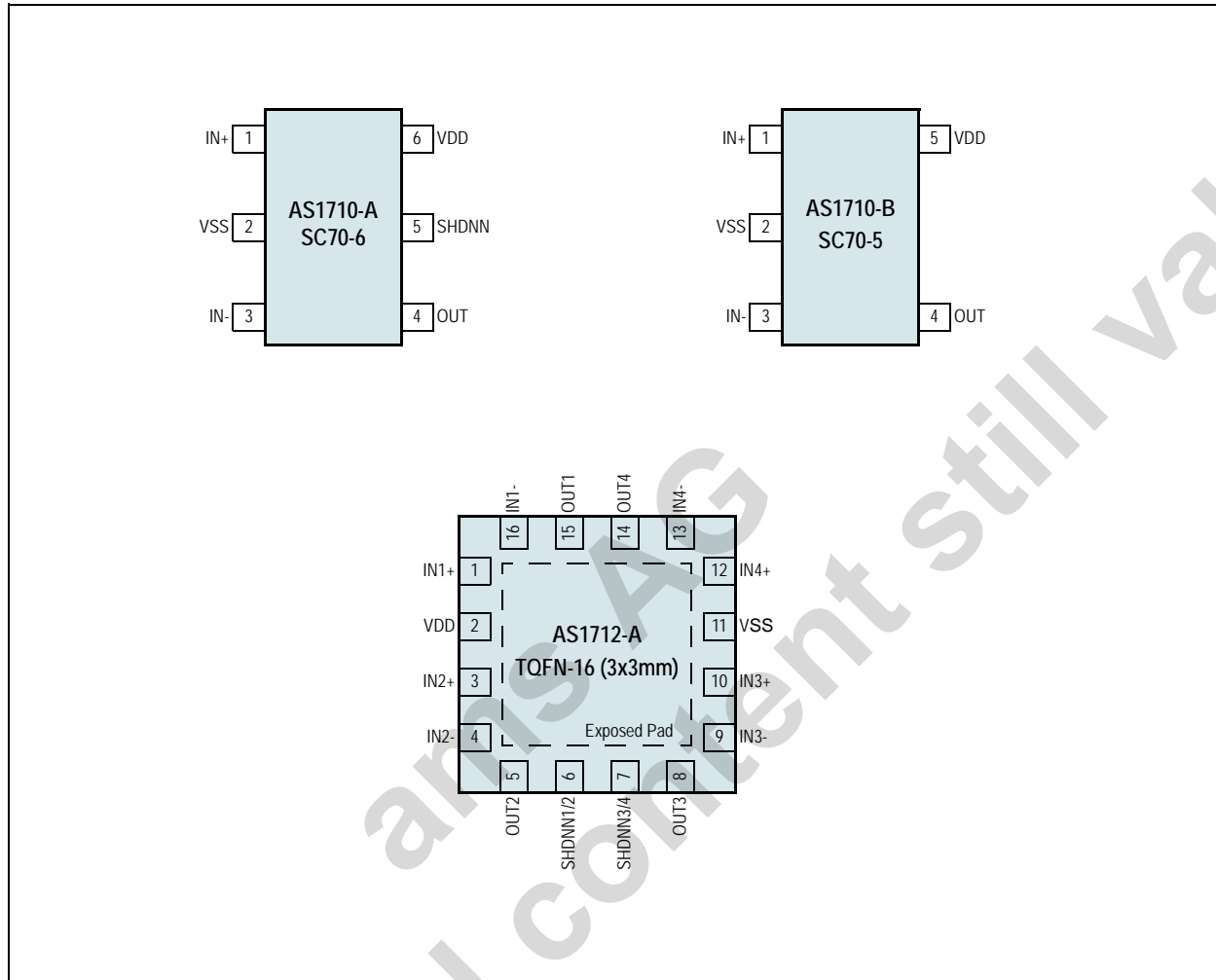

4.1 Pin Descriptions

Table 2. Pin Descriptions

Pin Number	Pin Name	Description
See Figure 2	IN+	Non-inverting Input
	IN-	Inverting Input
	VDD	Positive Supply Input
	VSS	Negative Supply Input. This pin must be connected to ground in single-supply applications.
	SHDNN	Active Low Shutdown Control
	OUT	Amplifier Output
	Exposed Pad	Exposed Pad. This pin also functions as a heat sink. Solder it to a large pad or to the circuit-board ground plane to maximize power dissipation.

5 Absolute Maximum Ratings

Stresses beyond those listed in [Table 3](#) may cause permanent damage to the device. These are stress ratings only, and functional operation of the device at these or any other conditions beyond those indicated in [Electrical Characteristics on page 4](#) is not implied. Exposure to absolute maximum rating conditions for extended periods may affect device reliability.

Table 3. Absolute Maximum Ratings

Parameter	Min	Max	Units	Comments	
Electrical Parameters					
Supply Voltage (VDD to VSS)		+7	V		
Supply Voltage (All Other Pins)	VSS - 0.3	VDD + 0.3	V		
Output Short-Circuit Duration to VDD or VSS		1	s		
Thermal Information					
Continuous Power Dissipation	SC70-5		247	mW	Derate at 31mW/°C above 70°C
	SC70-6		245		
Thermal Resistance Θ_{JA}	TQFN-16 (3x3mm)		33	°C/W	on PCB
Temperature Ranges and Storage Conditions					
Storage Temperature Range	-65	+150		°C	
Junction Temperature		+150		°C	
Package Body Temperature		+260		°C	The reflow peak soldering temperature (body temperature) specified is in accordance with <i>IPC/JEDEC J-STD-020 "Moisture/Reflow Sensitivity Classification for Non-Hermetic Solid State Surface Mount Devices"</i> . The lead finish for Pb-free leaded packages is matte tin (100% Sn).
Humidity non-condensing	5	85		%	
Moisture Sensitive Level		1			Represents a maximum floor life time of unlimited

6 Electrical Characteristics

All limits are guaranteed. The parameters with Min and Max values are guaranteed by production tests or SQC (Statistical Quality Control) methods.

6.1 DC Electrical Characteristics

$V_{DD} = 2.7V$, $V_{SS} = 0V$, $V_{CM} = V_{DD}/2$, $V_{OUT} = V_{DD}/2$, $R_{LOAD} = \text{Infinite}$, $V_{SHDNN} = V_{DD}$, Typical values at $T_{AMB} = 25^{\circ}C$.

Table 4. DC Electrical Characteristics

Symbol	Parameter	Condition	Min	Typ	Max	Unit	
TAMB	Operating Temperature Range		-40		+85	°C	
VDD	Supply Voltage Range	Inferred from Power Supply Rejection Ratio Test	2.7		5.5	V	
VOFFSET	Input Offset Voltage		-3	0.6	+3	mV	
IBIAS	Input Bias Current	$V_{CM} = V_{SS}$ to V_{DD}		50 ¹		pA	
IOFFSET	Input Offset Current	$V_{CM} = V_{SS}$ to V_{DD}		50 ¹		pA	
RIN	Input Resistance			1000 ¹		MΩ	
VCM	Common Mode Input Voltage Range	Inferred from Common Mode Rejection Ratio ¹	VSS		VDD	V	
CMRR	Common Mode Rejection Ratio	$V_{SS} < V_{CM} < V_{DD}$	-45	-70		dB	
PSRR	Power Supply Rejection Ratio	$V_{DD} = 2.7$ to $5.5V$	-70	-85		dB	
ROUT	Shutdown Output Impedance	$V_{SHDNN} = 0V$ (A-Versions)		130 ¹		Ω	
VOUT-SHDNN	Shutdown Output Voltage	$V_{SHDNN} = 0V$, $R_{LOAD} = 2k\Omega$ to V_{DD} (A-Versions)		170	300	mV	
AVOL	Large Signal Voltage Gain	$V_{SS} + 0.20V < V_{OUT} < V_{DD} - 0.20V$	$R_{LOAD} = 100k\Omega$	85	100	dB	
			$R_{LOAD} = 2k\Omega$	79	92		
			$R_{LOAD} = 200\Omega$	69	80		
VOUT	Output Voltage Swing	$V_{DD} - V_{OH}$ or $V_{OL} - V_{SS}$	$R_{LOAD} = 32\Omega$		350	650	mV
			$R_{LOAD} = 200\Omega$		70	120	
			$R_{LOAD} = 2k\Omega$		9	20	
	Output Voltage	$V_{DD} - V_{OH}$ or $V_{OL} - V_{SS}$				mV	
			$I_{LOAD} = 10mA$, $V_{DD} = 2.7V$	55	100		
			$I_{LOAD} = 30mA$, $V_{DD} = 5V$	100	180		
IOUT	Output Source/Sink Current	$V_{DD} = 2.7V$, $V_- = V_{CM}$, $V_+ = V_{CM} \pm 100mV$		100		mA	
		$V_{DD} = 5.0V$, $V_- = V_{CM}$, $V_+ = V_{CM} \pm 100mV$		200			
IDD	Quiescent Supply Current per Op Amp Output	$V_{DD} = 2.7V$, $V_{CM} = V_{DD}/2$		1.6	3.2	mA	
		$V_{DD} = 5.0V$, $V_{CM} = V_{DD}/2$		2.3	4.6		
IDD-SHDNN	Shutdown Supply Current per Op Amp (A-Versions)	$V_{SHDNN} = 0V$	$V_{DD} = 2.7V$	1	2000 ¹	nA	
	SHDNN Logic Threshold (A-Versions)	Shutdown Mode			$V_{SS} + 0.3$	V	
		Normal Operation			$V_{DD} - 0.3$		
	SHDNN Input Bias Current	$V_{SS} < V_{SHDNN} < V_{DD}$ (A-Versions)			50 ¹	pA	

1. Guaranteed by design.

6.2 AC Electrical Characteristics

$V_{DD} = 2.7V$, $V_{SS} = 0V$, $V_{CM} = V_{DD}/2$, $V_{OUT} = V_{DD}/2$, $R_{LOAD} = \text{Infinite}$, $V_{SHDNN} = V_{DD}$, Typical values at $T_{AMB} = 25^{\circ}C$.

Table 5. AC Electrical Characteristics

Symbol	Parameter	Conditions	Min	Typ	Max	Units
GBWP	Gain-Bandwidth Product	$V_{CM} = V_{DD}/2$		10		MHz
FPBW	Full-Power Bandwidth	$V_{OUT} = 2VP-P$, $V_{DD} = 5V$		2.5		MHz
SR	Slew Rate			10		V/ μ s
PM	Phase Margin			70		deg
GM	Gain Margin ¹			15		dB
THD+N	Total Harmonic Distortion Plus Noise	$f = 10kHz$, $V_{OUT} = 2VP-P$, $AV_{CL} = 1V/V$		0.05		%
CIN	Input Capacitance			6		pF
en	Voltage-Noise Density ¹	$f = 1kHz$		15		nV/ \sqrt{Hz}
		$f = 10kHz$		10		
	Capacitive-Load Stability	$AV_{CL} = 1V/V$, no sustained oscillations		100		pF
tSHDN	Shutdown Time (AS1710A)			1		μ s
tENABLE	Enable Time from Shutdown (AS1710A)			7		μ s
tON	Power-Up Time			20		ns

1. Guaranteed by design.

7 Typical Operating Characteristics

$V_{DD} = 2.7V$; $V_{SS} = 0V$; $V_{CM} = V_{DD}/2$; $V_{OUT} = V_{DD}/2$; $R_{LOAD} = \infty$; $V_{SHDN} = V_{DD}$ $T_{AMB} = +25^{\circ}C$ (unless otherwise specified).

Figure 3. Gain and Phase vs. Frequency

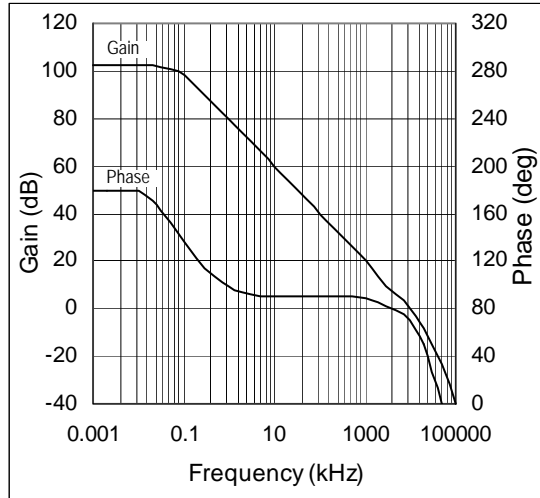

Figure 4. Gain and Phase vs. Frequency, $C_{LOAD} = 100pF$

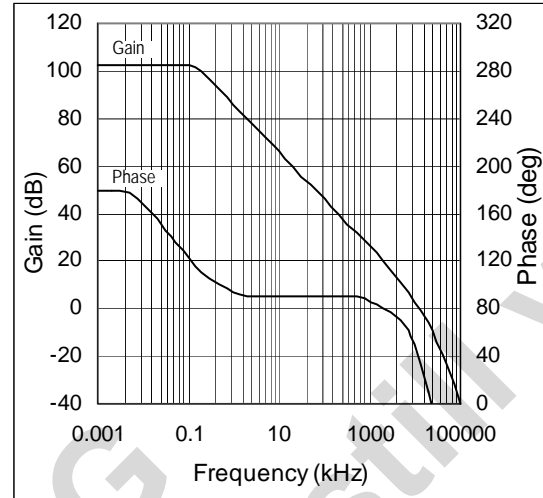

Figure 5. PSRR vs. Frequency

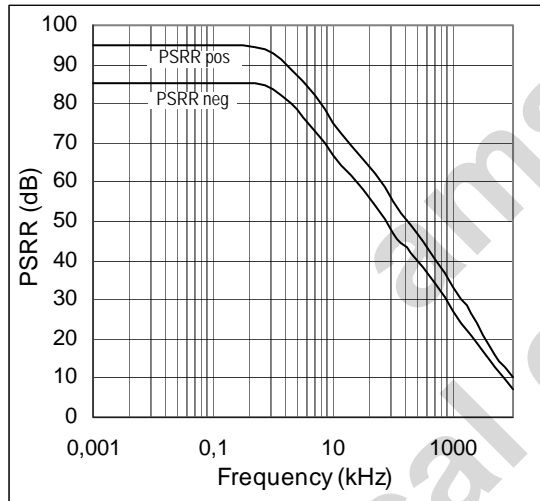

Figure 6. CMRR vs. Frequency

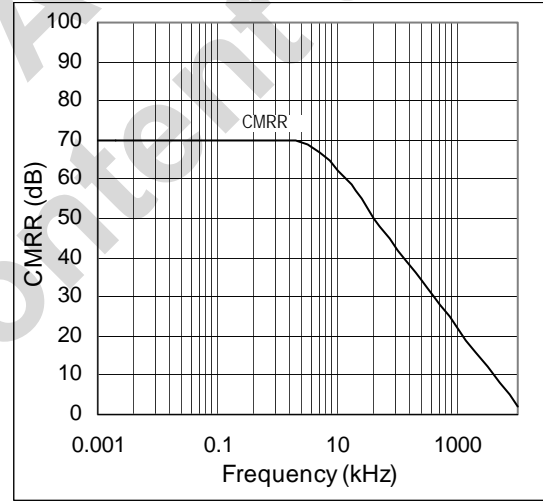

Figure 7. Supply Current vs. Temperature

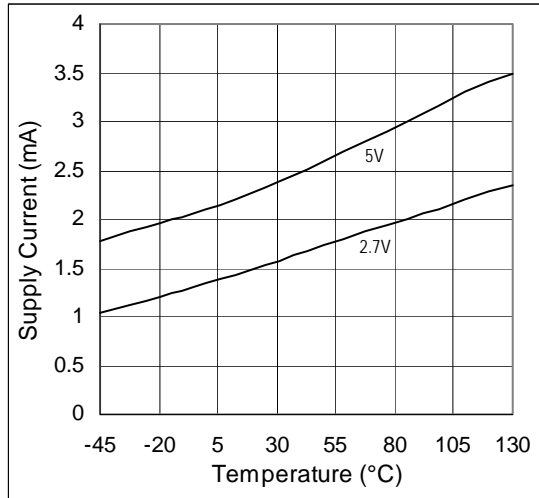

Figure 8. Shutdown Current vs. Temperature

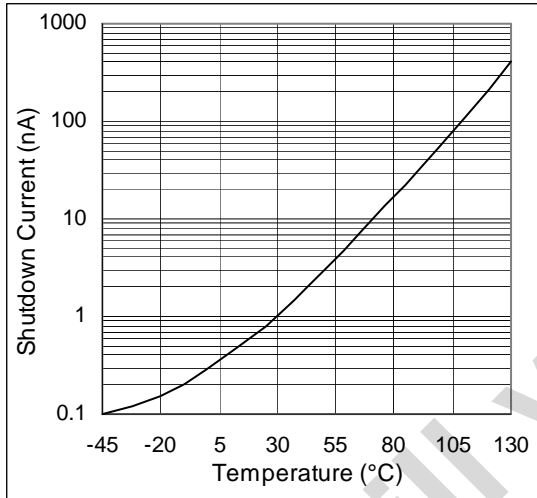

Figure 9. Supply Current vs. Common-Mode Voltage

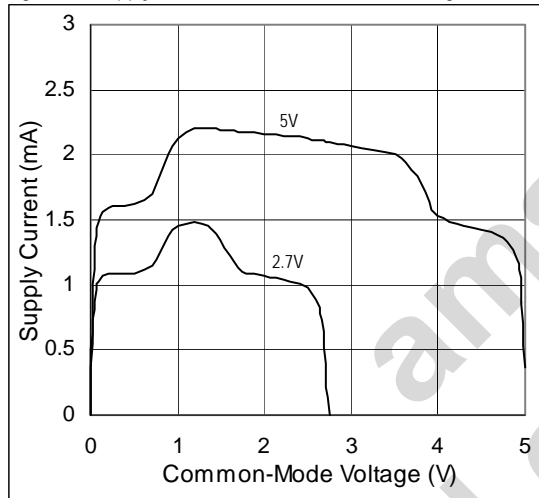

Figure 10. Input Voltage Noise vs. Frequency

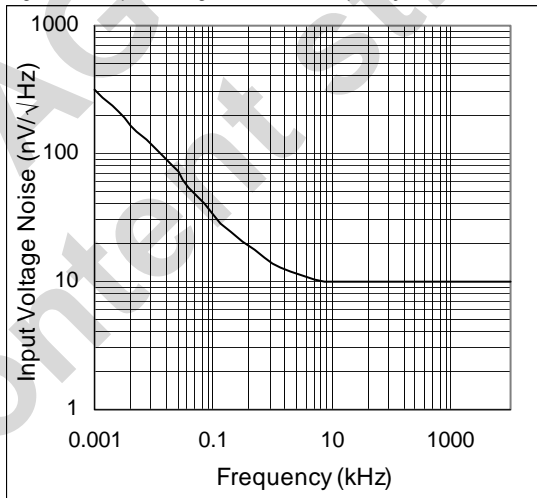

Figure 11. Output Voltage vs. Output Current, sourcing

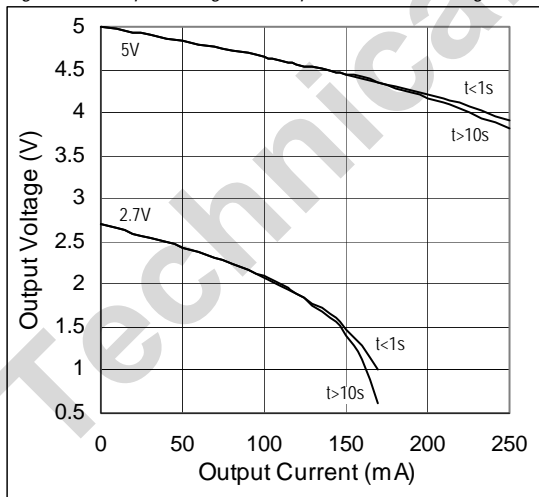

Figure 12. Output Voltage vs. Output Current, sinking

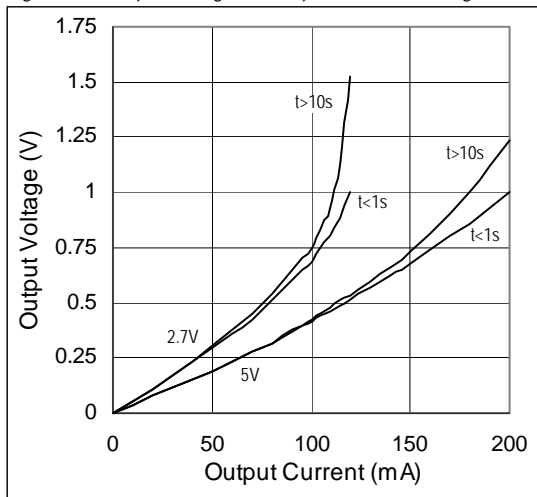

Figure 13. Output Swing High vs. Temperature

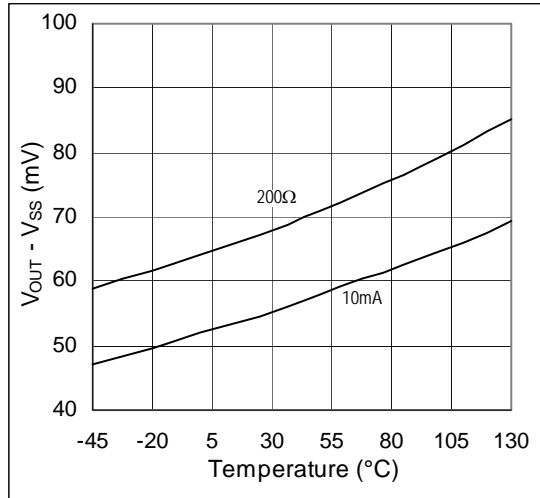

Figure 14. Output Swing Low vs. Temperature

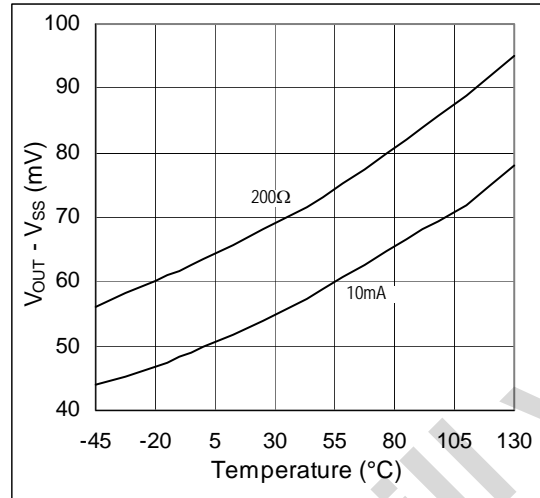

Figure 15. Transient Response, 100mV, 10pF load

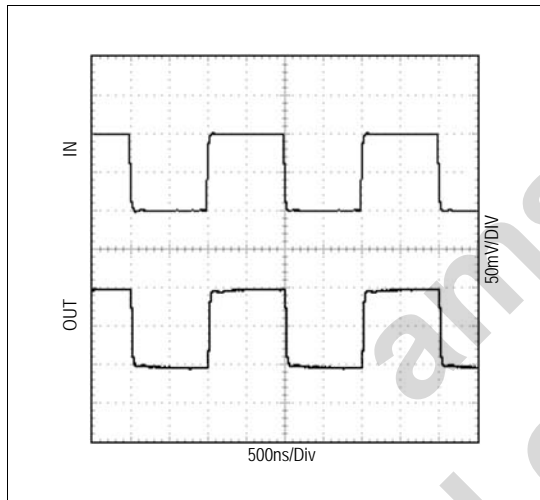

Figure 16. Transient Response, 100mV, 100pF load

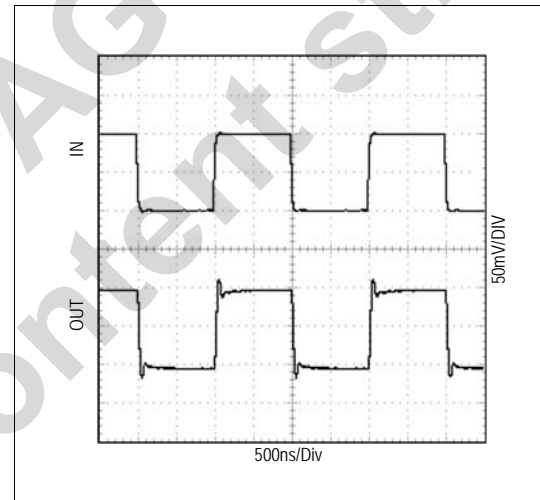

Figure 17. Transient Response, 1V, 10pF load

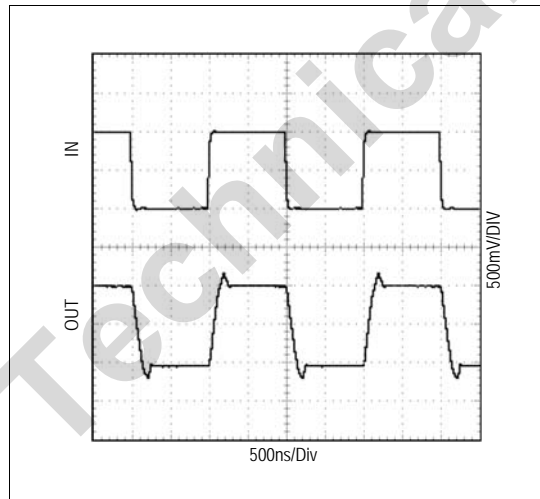

Figure 18. Transient Response, 1V, 100pF load

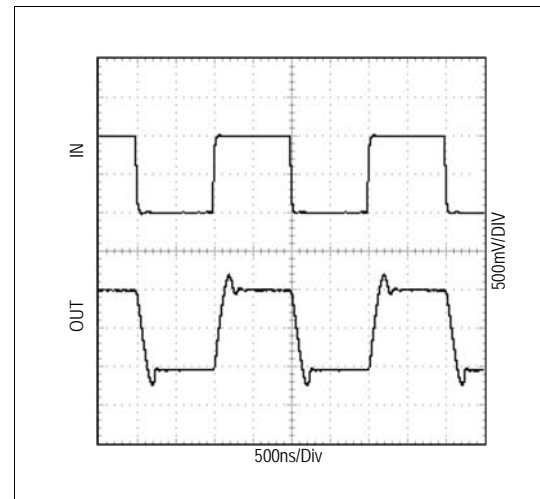

Figure 19. Transient Response, 2V, 10pF load

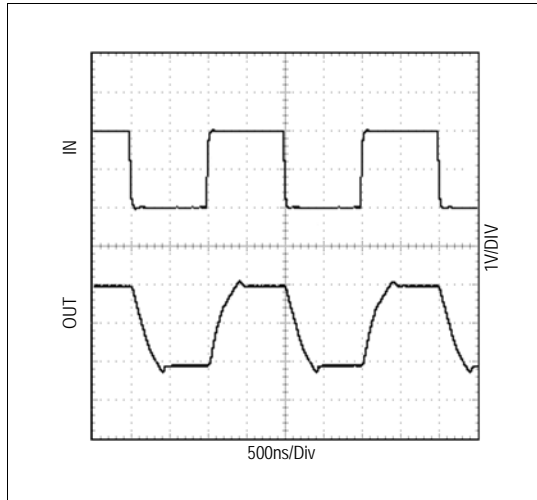
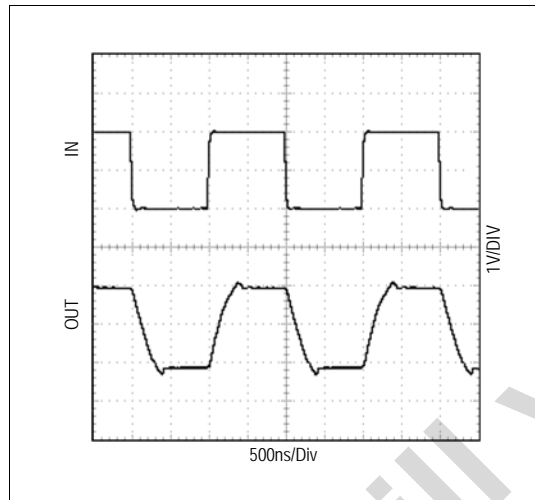

Figure 20. Transient Response, 2V, 100pF load



ams AG
Technical content still valid

8 Application Information

8.1 Package Power Dissipation

Caution: Due to the high output current drive, this op-amp can exceed the absolute maximum power-dissipation rating. Normally, when peak current is less than or equal to 40mA the maximum package power dissipation is not exceeded for any of the package types offered.

The absolute maximum power-dissipation rating of each package should always be verified. (EQ 1) gives an approximation of the package power dissipation:

$$P_{\text{PACKAGEDISS}} \cong V_{\text{RMS}} I_{\text{RMS}} \cos\theta \quad (\text{EQ 1})$$

Where:

V_{RMS} is the RMS voltage from V_{DD} to V_{OUT} when sourcing current, and from V_{OUT} to V_{SS} when sinking current.

I_{RMS} is the RMS current flowing in or out of the op-amp and the load.

θ is the phase difference between the voltage and the current. For resistive loads, $\cos\theta = 1$.

Figure 21. Typical AS1710/AS1712 Single-Supply Application

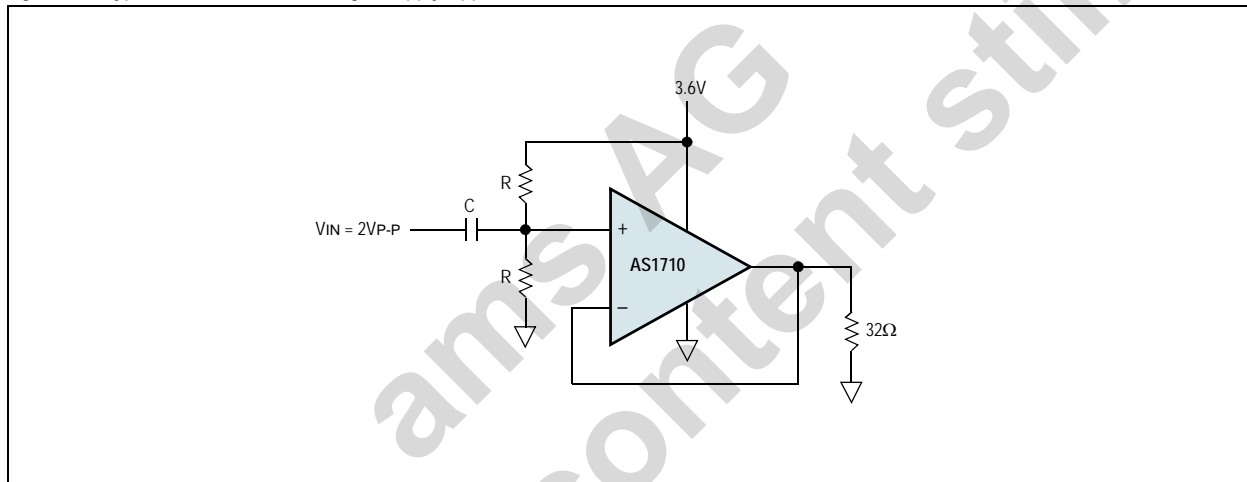

V_{RMS} can be calculated as:

$$V_{\text{RMS}} \cong (V_{\text{DD}} - V_{\text{DC}}) + V_{\text{PEAK}} / \sqrt{2} \quad (\text{EQ 2})$$

Where:

V_{DC} is the DC component of the output voltage.

V_{PEAK} is the highest positive excursion of the AC component of the output voltage.

For the circuit shown in Figure 21:

$$V_{\text{RMS}} = (3.6\text{V} - 1.8\text{V}) + 1.0\text{V} / \sqrt{2} = 2.507\text{VRMS}$$

I_{RMS} can be calculated as:

$$I_{\text{RMS}} \cong I_{\text{DC}} + (I_{\text{PEAK}} / \sqrt{2}) \quad (\text{EQ 3})$$

Where:

I_{DC} is the DC component of the output current.

I_{PEAK} is the highest positive excursion of the AC component of the output current.

For the circuit shown in Figure 21:

$$I_{\text{RMS}} = (1.8\text{V} / 32\Omega) + (1.0\text{V} / 32\Omega) / \sqrt{2} = 78.4\text{mARMS}$$

Therefore, for the circuit in Figure 21 the package power dissipation can be calculated as:

$$P_{\text{PACKAGEDISS}} = V_{\text{RMS}} I_{\text{RMS}} \cos\theta = 196\text{mW}$$

Adding a coupling capacitor improves the package power dissipation because there is no DC current to the load, as shown in Figure 22 on page 11.

8.2 60mW Single-Supply Stereo Headphone Driver

Two AS1710 amplifiers can be used as a single-supply, stereo headphone driver. The circuit shown in Figure 22 can deliver 60mW per channel with 1% distortion from a single 5V supply.

Figure 22. Stereo Headphone Driver Application (with Coupling Capacitor)

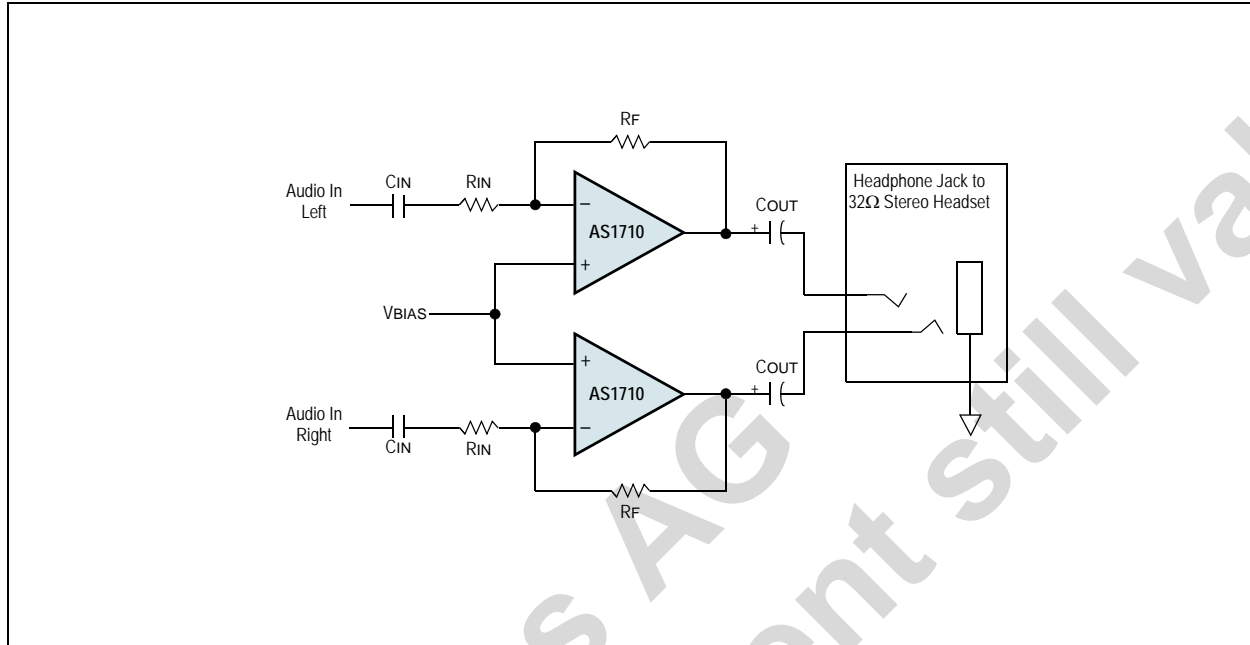

In Figure 22, C_{IN} and R_{IN} form a high-pass filter that removes the DC bias from the incoming signal. The -3dB point of the high-pass filter is given by:

$$f_{-3dB} = 1/(2\pi R_{IN} C_{IN}) \quad (EQ 4)$$

Choose gain-setting resistors R_{IN} and R_F according to the amount of desired gain, keeping in mind the maximum output amplitude.

C_{OUT} blocks the DC component of the amplifier output, preventing DC current flowing to the load. The output capacitor and the load impedance form a high-pass filter with the -3dB point determined by:

$$f_{-3dB} = 1/(2\pi R_{LOAD} C_{OUT}) \quad (EQ 5)$$

For a 32Ω load, a 100μF aluminum electrolytic capacitor gives a low-frequency pole at 50Hz.

8.3 Rail-to-Rail Input Stage

The AS1710/AS1712 CMOS op-amps have parallel connected N- and P-channel differential input stages that combine to accept a common-mode range extending to both supply rails. The N-channel stage is active for common-mode input voltages typically greater than ($V_{SS} + 1.2V$), and the p-channel stage is active for common-mode input voltages typically less than ($V_{DD} - 1.2V$).

8.4 Rail-to-Rail Output Stage

The minimum output is within millivolts of ground for single-supply operation, where the load is referenced to ground (V_{SS}). Figure 23 shows the input voltage range and the output voltage swing of an AS1710 connected as a voltage follower. The maximum output voltage swing is load dependent although it is guaranteed to be within 500mV of the positive rail ($V_{DD} = 2.7V$) even with maximum load (32Ω to ground).

Figure 23. Rail-to-Rail Input/Output Range, 100kΩ

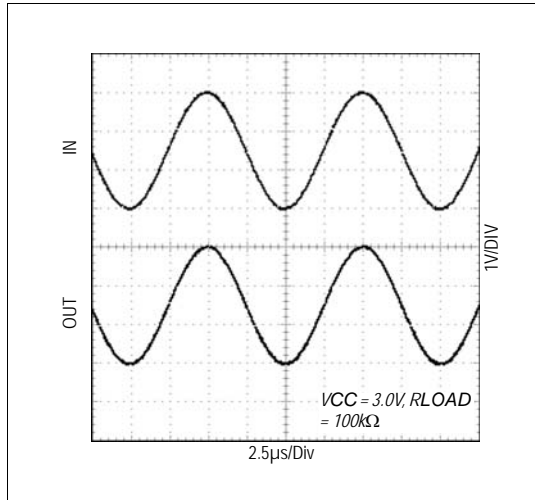
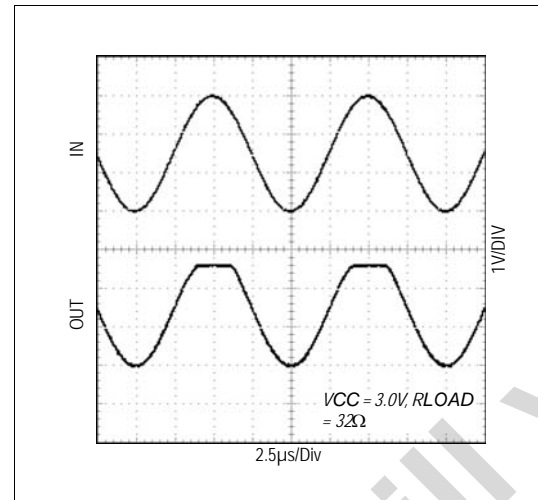

Figure 24. Rail-to-Rail Input/Output Range, 32Ω



Note: The absolute maximum ratings (see page 3) for power dissipation and output short-circuit duration (10s, max) must be adhered to since the output current can exceed 200mA (see Typical Operating Characteristics on page 6).

8.5 Input Capacitance

The parallel-connected differential input stages for rail-to-rail operation results in relatively large input capacitance C_{IN} (6pF typ). This introduces a pole at frequency $(2\pi R' C_{IN})^{-1}$, where R' is the parallel combination of the gain-setting resistors for the inverting or non-inverting amplifier configuration (Figure 25). If the pole frequency is less than or comparable to the unity-gain bandwidth (10MHz), the phase margin is reduced, and the amplifier exhibits degraded AC performance through either ringing in the step response or sustained oscillations.

Figure 25. Inverting and Non-inverting Amplifiers with Feedback Compensation

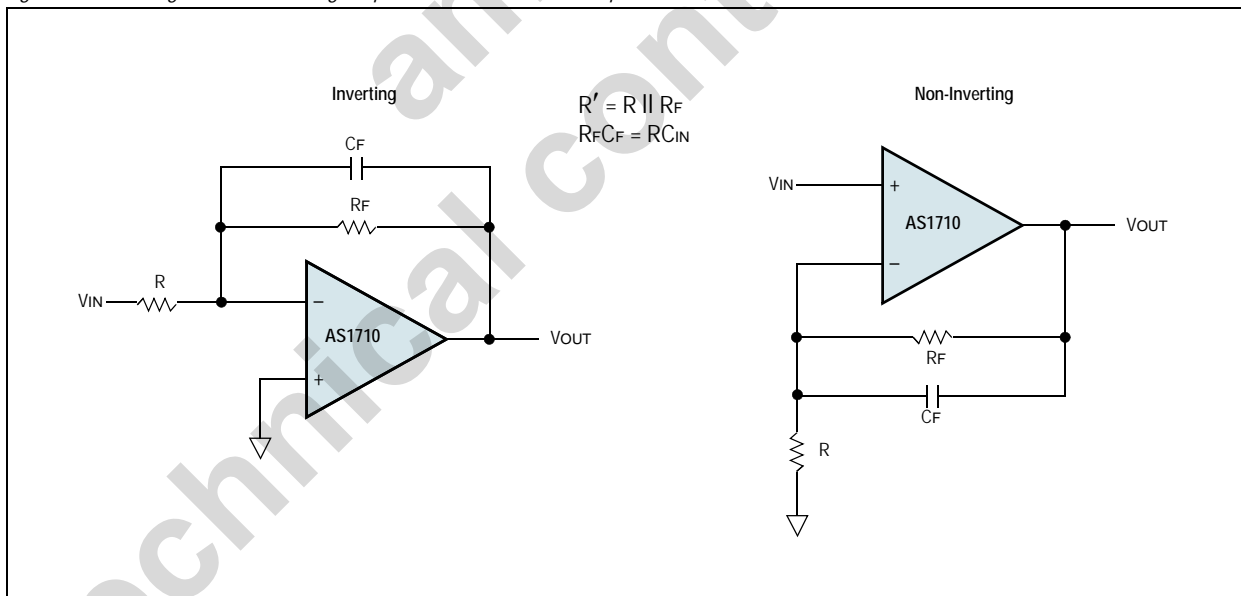

The pole frequency is 10MHz when $R' = 2k\Omega$. To maximize stability, $R' \ll 2k\Omega$ is recommended.

To improve step response when $R' > 2k\Omega$, connect a small capacitor (C_F) between the inverting input and output. C_F can be calculated by:

$$C_F = 6(R/R_F) \text{ [pF]} \quad (\text{EQ } 6)$$

Where:

R_F is the feedback resistor.

R is the gain-setting resistor.

8.6 Driving Capacitive Loads

The AS1710/AS1712 amplifiers have a high tolerance for capacitive loads, and are stable with capacitive loads up to 100pF.

Figure 26 shows a typical non-inverting capacitive-load driving circuit in the unity-gain configuration.

Figure 26. Capacitive-Load Driving Circuit

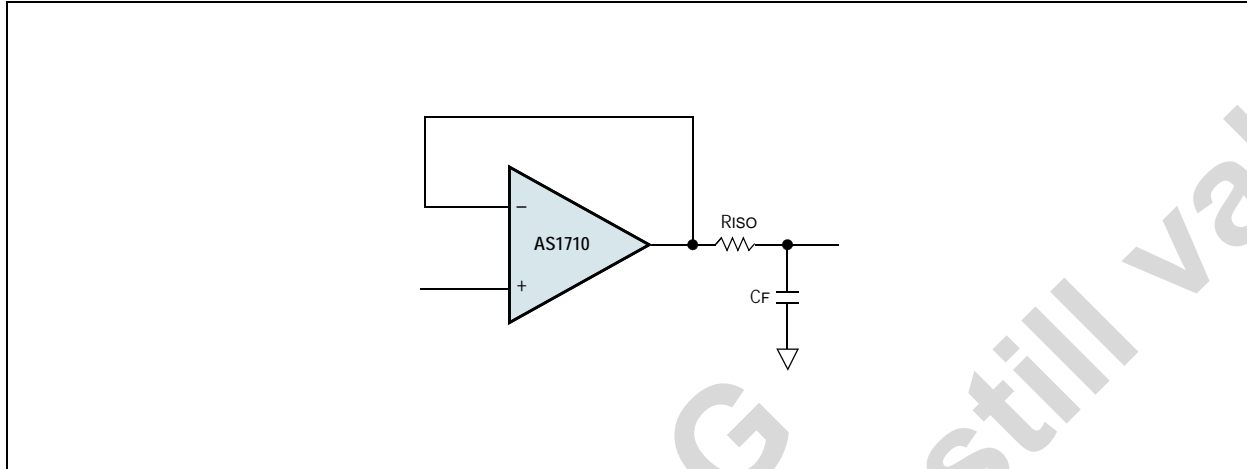

Note: Resistor RISO improves the circuit's phase margin by isolating the load capacitor from the AS1710/AS1712 output.

8.7 Power-Up

The AS1710/AS1712 typically settle within 5 μ s after power-up.

8.8 Shutdown

When SHDNN (not included in B versions) is pulled low, supply current drops to 0.5 μ A (per amplifier, VDD = 2.7V), the amplifiers are disabled, and their outputs are driven to VSS. Because the outputs are actively driven to VSS in shutdown, any pull-up resistor on the output causes a current drain from the supply.

Note: Pulling SHDNN high enables the amplifier. In the AS1712 the amplifiers shutdown in pairs.

When exiting shutdown, there is a 6 μ s delay before the amplifier output becomes active.

8.9 Power Supplies and Layout

The AS1710/AS1712 can operate from a single 2.7 to 5.5V supply or from dual \pm 1.35 to \pm 2.5V supplies. Good design improves device performance by decreasing the amount of stray capacitance at the op-amp inputs/outputs.

- For single-supply operation, bypass the power supply with a 0.1 μ F ceramic capacitor.
- For dual-supply operation, bypass each supply to ground.
- Decrease stray capacitance by placing external components close to the op-amp pins, minimizing trace and lead lengths.

9 Package Drawings and Markings

The devices are available in a SC70-5, SC70-6, and TOFN-16 (3x3mm) package.

Figure 27. SC70-5 Package

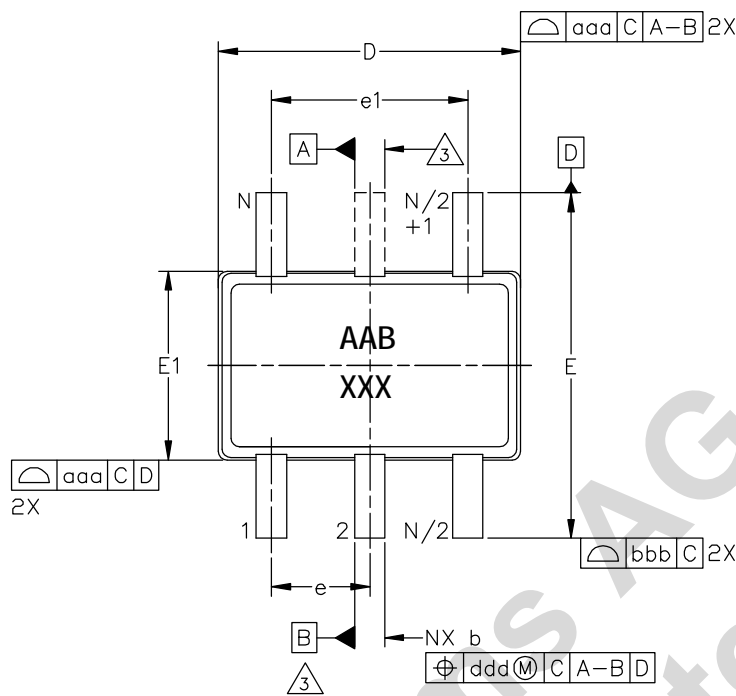

Symbol	Min	Nom	Max
A	-	-	1.10
A1	-	-	0.10
A2	0.70	0.90	1.00
b	0.15	-	0.30
c	0.08	-	0.22
D	2.00 BSC		
E	2.10 BSC		
E1	1.25 BSC		
e	0.65 BSC		
e1	1.30 BSC		
L	0.26	0.36	0.46
L1	0.42 REF		
L2	0.15 BSC		
R	0.10	-	-
R1	0.10	-	0.25
θ	0°	4°	8°
θ_1	4°	-	12°
aaa	-	0.15	-
bbb	-	0.30	-
ccc	-	0.10	-
ddd	-	0.10	-
N	5		

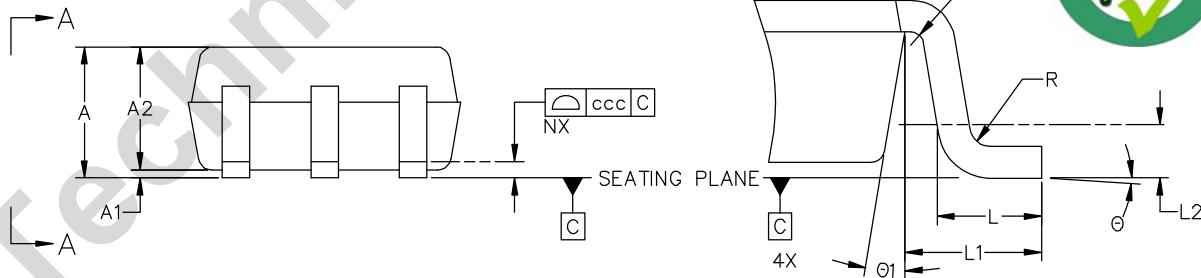
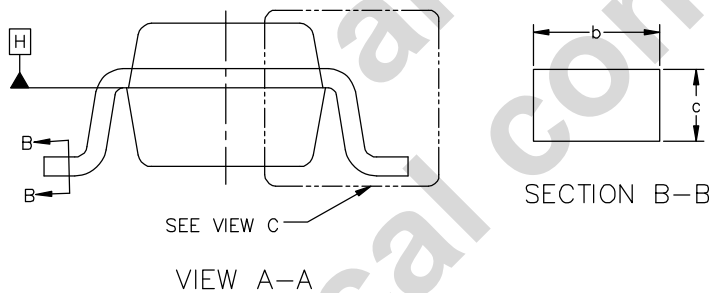

Notes:

1. Dimensions and tolerancing conform to ASME Y14.5M-1994.
2. All dimensions are in millimeters. Angles are in degrees.
3. Datums A and B to be determined at datum H.

Figure 28. SC70-6 Package

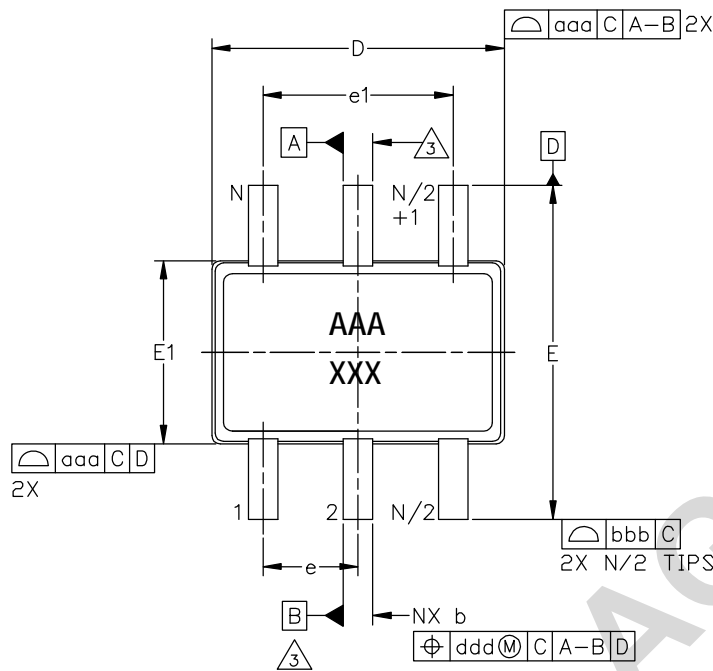

Symbol	Min	Nom	Max
A	-	-	1.10
A1	-	-	0.10
A2	0.70	0.90	1.00
b	0.15	-	0.30
c	0.08	-	0.22
D	2.00 BSC		
E	2.10 BSC		
E1	1.25 BSC		
e	0.65 BSC		
e1	1.30 BSC		
L	0.26	0.36	0.46
L1	0.42 REF		
L2	0.15 BSC		
R	0.10	-	-
R1	0.10	-	0.25
θ	0°	4°	8°
θ_1	4°	-	12°
aaa	-	0.15	-
bbb	-	0.30	-
ccc	-	0.10	-
ddd	-	0.10	-
N	6		

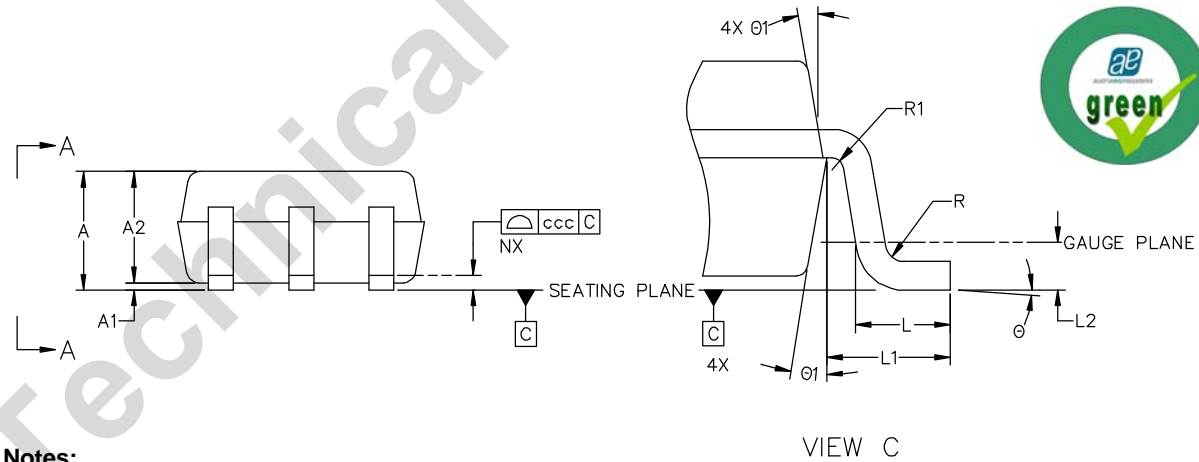
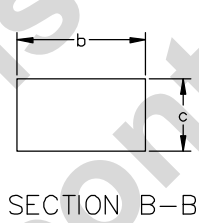
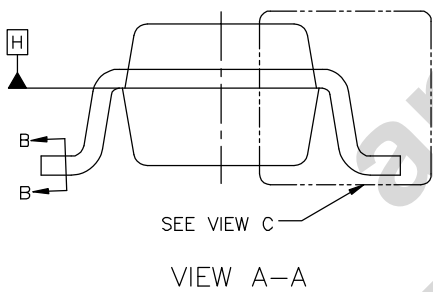

Notes:

1. Dimensions and tolerancing conform to ASME Y14.5M-1994.
2. All dimensions are in millimeters. Angles are in degrees.
3. Datums A and B to be determined at datum H.

Figure 29. TQFN-16 (3x3mm)

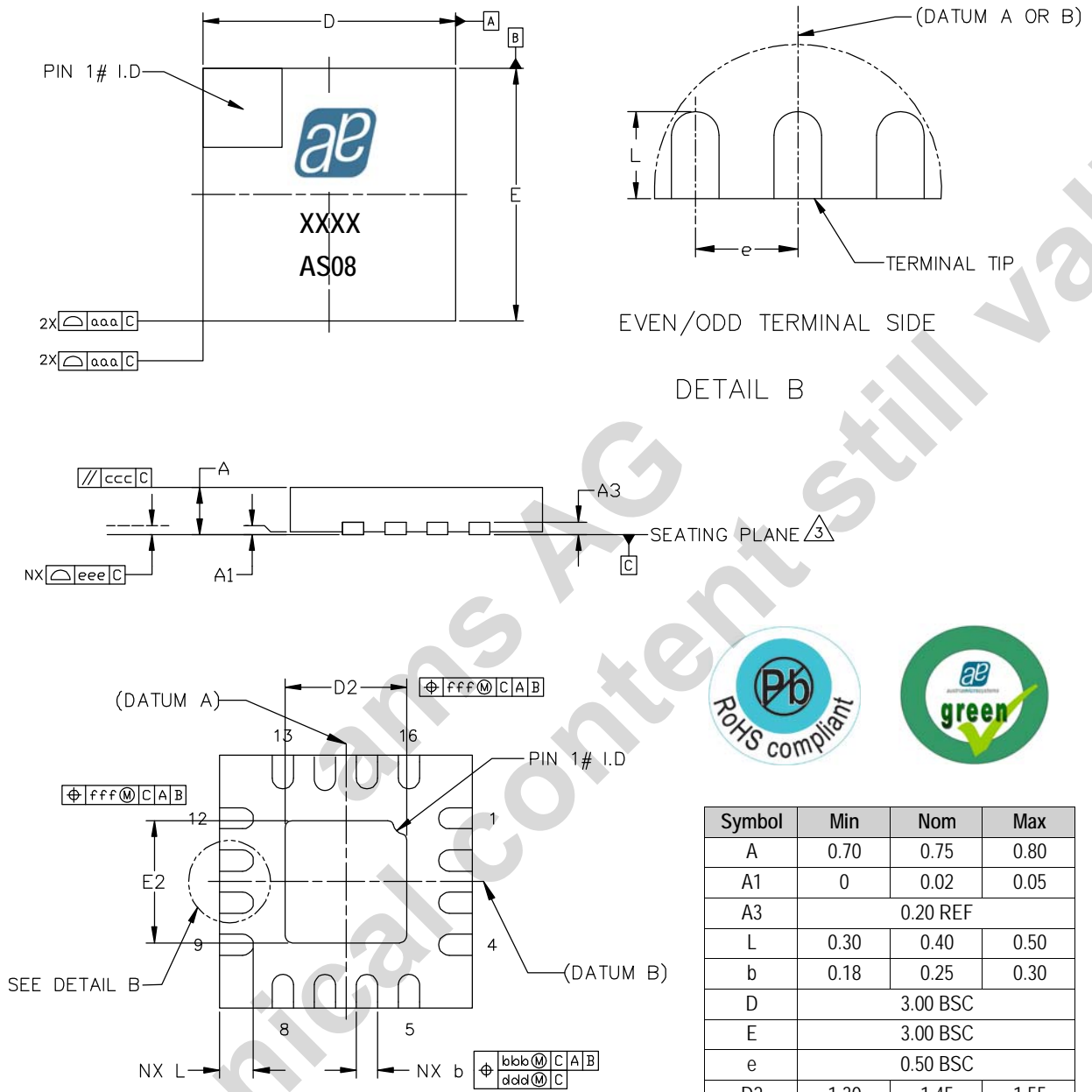

Symbol	Min	Nom	Max
A	0.70	0.75	0.80
A1	0	0.02	0.05
A3	0.20 REF		
L	0.30	0.40	0.50
b	0.18	0.25	0.30
D	3.00 BSC		
E	3.00 BSC		
e	0.50 BSC		
D2	1.30	1.45	1.55
E2	1.30	1.45	1.55
aaa	-	0.15	-
bbb	-	0.10	-
ccc	-	0.10	-
ddd	-	0.05	-
eee	-	0.08	-
fff	-	0.10	-
N	16		

Notes:

1. Dimensions and tolerancing conform to ASME Y14.5M-1994.
2. All dimensions are in millimeters. Angles are in degrees.
3. Coplanarity applies to the exposed heat slug as well as the terminal.
4. Radius on terminal is optional.
5. N is the total number of terminals.

Revision History

Revision	Date	Owner	Description
1.8	-	-	Initial revision
1.9	01 Aug, 2011	afe	Updated Electrical Characteristics (page 4) , Package Drawings and Markings (page 14) .

Note: Typos may not be explicitly mentioned under revision history.

ams AG
Technical content still valid

10 Ordering Information

The device is available as the standard products shown in [Table 6](#).

Table 6. Ordering Information

Ordering Code	Marking	Description	Delivery Form	Package
AS1710A-ASCT	AAA	Single Op Amp with Shutdown	Tape and Reel	SC70-6
AS1710B-ASCT	AAB	Single Op Amp	Tape and Reel	SC70-5
AS1712A-AQFT	ASO8	Quad Op Amp with Shutdown	Tape and Reel	TOFN-16 (3x3mm)

Note: All products are RoHS compliant and austriamicrosystems green.
Buy our products or get free samples online at ICdirect: <http://www.austriamicrosystems.com/ICdirect>

Technical Support is available at <http://www.austriamicrosystems.com/Technical-Support>

For further information and requests, please contact us <mailto:sales@austriamicrosystems.com>
or find your local distributor at <http://www.austriamicrosystems.com/distributor>

Copyrights

Copyright © 1997-2011, austriamicrosystems AG, Tobelbaderstrasse 30, 8141 Unterpremstaetten, Austria-Europe. Trademarks Registered ®. All rights reserved. The material herein may not be reproduced, adapted, merged, translated, stored, or used without the prior written consent of the copyright owner.

All products and companies mentioned are trademarks or registered trademarks of their respective companies.

Disclaimer

Devices sold by austriamicrosystems AG are covered by the warranty and patent indemnification provisions appearing in its Term of Sale. austriamicrosystems AG makes no warranty, express, statutory, implied, or by description regarding the information set forth herein or regarding the freedom of the described devices from patent infringement. austriamicrosystems AG reserves the right to change specifications and prices at any time and without notice. Therefore, prior to designing this product into a system, it is necessary to check with austriamicrosystems AG for current information. This product is intended for use in normal commercial applications. Applications requiring extended temperature range, unusual environmental requirements, or high reliability applications, such as military, medical life-support or life-sustaining equipment are specifically not recommended without additional processing by austriamicrosystems AG for each application. For shipments of less than 100 parts the manufacturing flow might show deviations from the standard production flow, such as test flow or test location.

The information furnished here by austriamicrosystems AG is believed to be correct and accurate. However, austriamicrosystems AG shall not be liable to recipient or any third party for any damages, including but not limited to personal injury, property damage, loss of profits, loss of use, interruption of business or indirect, special, incidental or consequential damages, of any kind, in connection with or arising out of the furnishing, performance or use of the technical data herein. No obligation or liability to recipient or any third party shall arise or flow out of austriamicrosystems AG rendering of technical or other services.



Contact Information

Headquarters

austriamicrosystems AG
Tobelbaderstrasse 30
A-8141 Unterpremstaetten, Austria

Tel: +43 (0) 3136 500 0

Fax: +43 (0) 3136 525 01

For Sales Offices, Distributors and Representatives, please visit:

<http://www.austriamicrosystems.com/contact>

Mouser Electronics

Authorized Distributor

Click to View Pricing, Inventory, Delivery & Lifecycle Information:

[ams:](#)

[AS1710B-ASCT](#) [AS1710A-ASCT](#)