

Special Series

Various Coupling

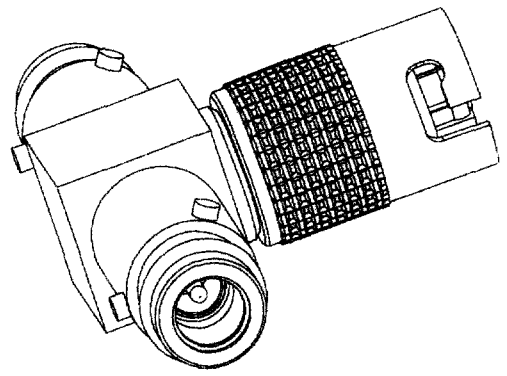

Features

- Small
- Improved Vibration Characteristics
- Resistance to RF leakage
- Plugs incorporate safety wiring holes in the coupling sleeve so that they may be wired in place in severe vibration conditions.
- Made to MIL-C-39012

Options

- Small and Medium Sized Cables
- Straight, Right-Angle, Long Crimp, Short Crimp, Flange Mount, Single Hole Mount, Printed Circuit Board, Cap and Chain, Termination, Cross and Tee types available
- Adapters available

Specifications

- MIL-C-39012
- QQ-B-626
- MIL-STD-202
- QQ-C-530
- MIL-G-45204
- QQ-S-365
- ZZ-R-765

Technical Data

Materials

- Body Parts Brass, QQ-B-626 1/2 HD.
- Contacts
 - ▶ Male Brass
 - ▶ Female Beryllium copper QQ-C-530
- Insulators PTFE Fluorocarbon
- Gaskets Silicone Rubber ZZ-R-765

Plating

All parts plated to meet finish and corrosion requirements of MIL-C-39012

- Finish
 - ▶ Gold MIL-G-45204
 - ▶ Nickel IP23
 - ▶ Silver QQ-S-365

Operating Environment

- Temperature range -65°C to +165°C
- Vibration MIL-STD-202, method 204, cond D. (20 G's)
- Shock MIL-STD-202, method 213, cond. I (100 G's)
- Thermal shock MIL-STD-202, method 107, cond. B -65°C to +115°C
- Corrosion (salt spray) . MIL-STD-202, method 101, cond. B
- Moisture Resistance MIL-STD-202, method 106

Packaging

- Single Bags
- Custom packaging available upon request.

Customer Support Materials

Description	Order No.
Customer Product Drawings.....	By Part Number
Product Substitutions	Contact Technical Support

Description	Order No.
Product Samples	Upon Request
Test Data	Upon Request

Special Receptacles



Description
Receptacle Plug -
Push On Single Hole Mount Straight

Ordering Data						
Receptacle Plug - Push On Single Hole Mount Straight						
Part Number	Dimension				Finish	Mtg. Hole
	A		B			
	mm	in.	mm	in.		
33PR101-1	24.21	0.953	12.70	0.500	Silver	C3
33PR117-1	24.21	0.953	12.70	0.500	Silver	C3



Description
Receptacle Jack -
Push On Single Hole Mount Straight

Ordering Data						
Receptacle Jack - Push On Single Hole Mount Straight						
Part Number	Dimension				Finish	Mtg. Hole
	A		B			
	mm	in.	mm	in.		
33JR103-1	24.21	0.953	12.70	0.500	Silver	C3

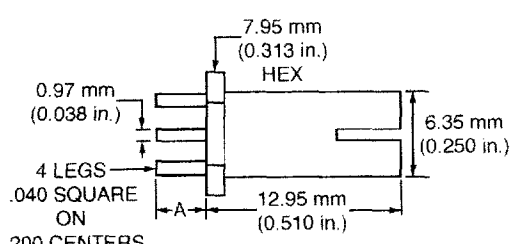

Description
Receptacle Probe -
Printed Circuit Board Mount Straight

Ordering Data					
Receptacle Probe - Printed Circuit Board Mount Straight					
Part Number	Dimension A		Finish	Mtg. PCB	
	mm	in.			
	33JR135-1	3.81			0.150
33JR135-4	4.57	0.180	Silver	A1	

To obtain Assembly Instructions contact Berg Electronics at 1-800-237-2374 Ext.-2800

**Special Series
Receptacle**

**Description
Receptacle Probe -
Printed Circuit Board Mount Right-Angle**

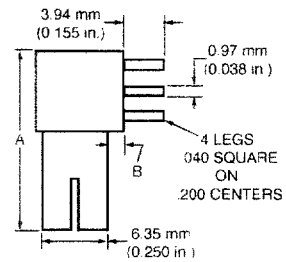

**Ordering Data
Receptacle Probe - Printed Circuit Board Mount Right-Angle**

Part Number	Dimension				Finish	Mtg. PCB
	A		B			
	mm	in.	mm	in.		
33JR159-1	20.64	0.813	3.18	0.125	Nickel	A1
33JR159-2	17.46	0.688	1.59	0.063	Nickel	A1

**Description
Receptacle Probe -
Single Hole Mount Straight**

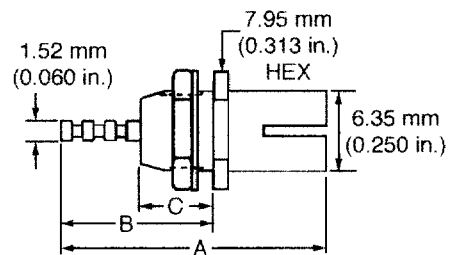

**Ordering Data
Receptacle Probe - Single Hole Mount Straight**

Part Number	Dimension						Finish	Mtg. Hole
	A		B		C			
	mm	in.	mm	in.	mm	in.		
33JR115-2	20.64	0.813	11.91	0.469	5.56	0.219	Nickel	C8
33JR126-1	20.64	0.813	11.91	0.469	7.14	0.281	Nickel	C8
33JR167-1	17.07	0.672	8.33	0.328	5.56	0.219	Nickel	C8
33JR169-1	20.64	0.813	11.91	0.469	8.33	0.328	Nickel	C8

**Description
Receptacle Probe - Single Hole Mount Right-Angle**

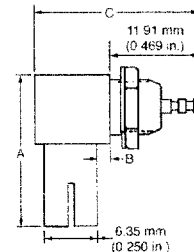

**Ordering Data
Receptacle Probe - Single Hole Mount Right-Angle**

Part Number	Dimension						Finish	Mtg. Hole
	A		B		C			
	mm	in.	mm	in.	mm	in.		
33JR170-1	20.64	0.813	3.18	0.125	20.64	0.813	Nickel	C8

To obtain Assembly Instructions contact Berg Electronics at 1-800-237-2374 Ext.-2800

Special Adapters

Description

Adapter - BNC Plug to Probe Receptacle Straight

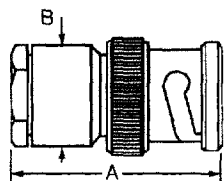

Ordering Data

Adapter - BNC Plug to Probe Receptacle Straight

Part Number	Adapter Ends	Dimension				Finish
		A		B		
		mm	in.	mm	in.	
28P156-1	Tektronix Probe-BNC Jack	25.80	1.016	12.70	0.500	Silver

Description

Adapter - F Series Jack to Push On Jack Straight

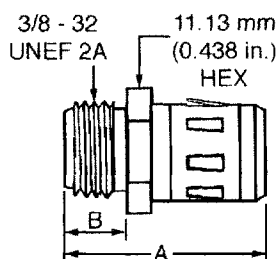

Ordering Data

Adapter - F Series Jack to Push On Jack Straight

Part Number	Adapter Ends	Dimension				Finish
		A		B		
		mm	in.	mm	in.	
33A119-1	Jack-Push on Jack 75 Ohm 35DB-1 GHz	23.81	0.938	9.53	0.375	Nickel

Description

Adapter - F Series Jack to Push On Plug Straight

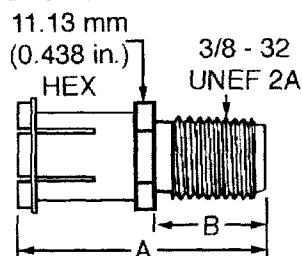

Ordering Data

Adapter - F Series Jack to Push On Plug Straight

Part Number	Adapter Ends	Dimension				Finish
		A		B		
		mm	in.	mm	in.	
33A118-1	Jack-Push on Plug 75 35DB-1 GHz	27.78	1.094	13.89	0.547	Nickel

To obtain Assembly Instructions contact Berg Electronics at 1-800-237-2374 Ext.-2800

Special Series
Adapter

Description

Adapter - F Series Jack to 75 Ohm BNC Plug

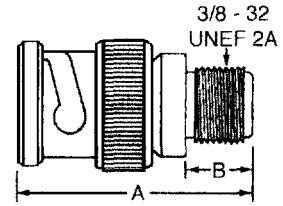

Ordering Data

Adapter - F Series Jack to 75 Ohm BNC Plug

Part Number	Adapter Ends	Dimension				Finish
		A		B		
		mm	in.	mm	in.	
29JP218-1	BNC 75 Ohm Plug-F Jack 75 Ohm 35dB-1 GHz	26.99	1.063	6.35	0.250,	Nickel
29JP218-2	BNC 75 Ohm Plug-F Jack 75 Ohm 35dB-1 GHz	30.96	1.219	10.31	0.406,	Nickel

To obtain Assembly Instructions contact Berg Electronics at 1-800-237-2374 Ext.-2800