



**2M x 8 SRAM MODULE**

**SYS82000RKXD - 85/10/12**

Issue 1.4 : April 2001

**Description**

The SYS82000RKXD is a plastic 16Mbit Static RAM Module housed in a standard 36 pin Single-In-Line package organised as 2M x 8. This offers an extremely high PCB packing density.

The module is constructed using four 512Kx8 SRAMs in TSOPII packages mounted on a FR4 epoxy substrate. Access times are 85, 100 and 120ns.

The SYS82000RKXD is offered in standard and low power versions, with the -L module having a low voltage data retention mode for battery backed applications.

**Features**

- Access Times of 85/100/120ns.
- 36 Pin Industry Standard Single-In-Line package.
- 5 Volt Supply  $\pm 10\%$  .
- Power Dissipation :
  - Operating (min cycle) 610 mW (max).
  - Standby -L Version (CMOS) 2.2 mW (max).
- Completely Static Operation.
- Equal Access and Cycle Times.
- Low Voltage  $V_{CC}$  Data Retention.
- Directly TTL Compatible.
- On-board Decoding & Capacitors.
- Compatible with the SYS8512RKX, SYS81000RKXB and SYS82000RKX modules.

**Block Diagram**

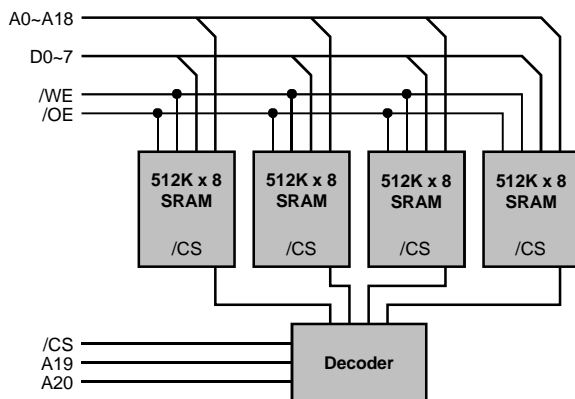

**Pin Definition**

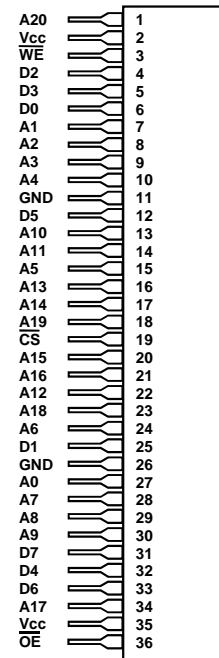

**Pin Functions**

<i>Address Inputs</i>	<b>A0 - A20</b>
<i>Data Input/Output</i>	<b>D0 - D7</b>
<i>Chip Select</i>	<b><math>\overline{CS}</math></b>
<i>Write Enable</i>	<b><math>\overline{WE}</math></b>
<i>Output Enable</i>	<b><math>\overline{OE}</math></b>
<i>No Connect</i>	<b>NC</b>
<i>Power (+5V)</i>	<b><math>V_{CC}</math></b>
<i>Ground</i>	<b>GND</b>

**Package Details**

Plastic 36 Pin Single-In-Line (SIP)

**DC OPERATING CONDITIONS****Absolute Maximum Ratings** <sup>(1)</sup>

Parameter	Symbol	Min	Typ	Max	Unit
Voltage on any pin relative to $V_{SS}$	$V_T^{(2)}$	-0.3	-	7.0	V
Power Dissipation	$P_T$	-	4.0	-	W
Storage Temperature	$T_{STG}$	-55	-	125	°C

Notes : (1) Stresses above those listed may cause permanent damage to the device. This is a stress rating only and functional operation of the device at those or any other conditions above those indicated in the operational sections of this specification is not implied. Exposure to absolute maximum rating conditions for extended periods may affect device reliability.

**Recommended Operating Conditions**

Parameter	Symbol	Min	Typ	Max	Unit
Supply Voltage	$V_{CC}$	4.5	5.0	5.5	V
Input High Voltage	$V_{IH}$	2.2	-	$V_{CC}+0.3$	V
Input Low Voltage	$V_{IL}$	-0.3	-	0.8	V
Operating Temperature	(Commercial) $T_A$	0	-	70	°C
	(Industrial) $T_{AI}$	-40	-	85	°C

**DC Electrical Characteristics** ( $V_{CC}=5V\pm 10\%$ )  $T_A$  0 to 70 °C

Parameter	Symbol	Test Condition	Min	Typ	max	Unit
I/P Leakage Current Address, $\overline{OE}$ , $\overline{WE}$	$I_{LI}$	$0V \leq V_{IN} \leq V_{CC}$	-4	-	4	$\mu A$
Output Leakage Current	$I_{LO}$	$\overline{CS} = V_{IH}$ , $V_{IO} = GND$ to $V_{CC}$	-4	-	4	$\mu A$
Average Supply Current	$I_{CC1}$	Min. Cycle, $\overline{CS} = V_{IL}$ , $V_{IL} \leq V_{IN} \leq V_{IH}$	-	-	110	mA
Standby Supply Current	TTL levels $I_{SB1}$	$\overline{CS} = V_{IH}$	-	-	12	mA
	CMOS levels $I_{SB2}$	$\overline{CS} \geq V_{CC}-0.2V$ , $0.2 \leq V_{IN} \leq V_{CC}-0.2V$	-	-	8	mA
	-L Version (CMOS) $I_{SB3}$	$\overline{CS} \geq V_{CC}-0.2V$ , $0.2 \leq V_{IN} \leq V_{CC}-0.2V$	-	-	400	$\mu A$
Output Voltage	$V_{OL}$	$I_{OL} = 2.1mA$	-	-	0.4	V
	$V_{OH}$	$I_{OH} = -1.0mA$	2.4	-	-	V

Typical values are at  $V_{CC}=5.0V$ ,  $T_A=25^\circ C$  and specified loading.

**Capacitance** ( $V_{CC}=5V\pm 10\%$ ,  $T_A=25^\circ C$ )

Note: Capacitance calculated, not measured.

Parameter	Symbol	Test Condition	max	Unit
Input Capacitance (Address, $\overline{OE}$ , $\overline{WE}$ )	$C_{IN1}$	$V_{IN} = 0V$	32	pF
I/P Capacitance (other)	$C_{IN2}$	$V_{IN} = 0V$	8	pF
I/O Capacitance	$C_{IO}$	$V_{IO} = 0V$	40	pF

**AC Test Conditions****Output Load**

- \* Input pulse levels: 0V to 3.0V
- \* Input rise and fall times: 5ns
- \* Input and Output timing reference levels: 1.5V
- \* Output load: see diagram
- \*  $V_{CC}=5V\pm 10\%$

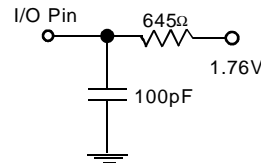
**Operation Truth Table**

$\overline{CS}$	$\overline{OE}$	$\overline{WE}$	DATA PINS	SUPPLY CURRENT	MODE
H	X	X	High Impedance	$I_{SB1}, I_{SB2}, I_{SB3}$	Standby
L	L	H	Data Out	$I_{CC1}$	Read
L	H	L	Data In	$I_{CC1}$	Write
L	L	L	Data In	$I_{CC1}$	Write
L	H	H	High-Impedance	$I_{SB1}, I_{SB2}, I_{SB3}$	High-Z

Notes : H =  $V_{IH}$  : L =  $V_{IL}$  : X =  $V_{IH}$  or  $V_{IL}$

**Low  $V_{CC}$  Data Retention Characteristics - L Version Only**

Parameter	Symbol	Test Condition	min	typ <sup>(1)</sup>	max	Unit
$V_{CC}$ for Data Retention	$V_{DR}$	$\overline{CS} \geq V_{CC} - 0.2V$				
Data Retention Current		$V_{CC} = 3.0V, \overline{CS} \geq V_{CC} - 0.2V$	2.0	-	-	V
	$I_{CCDR1}$ <sup>(2)</sup>	$T_{OP} = 0^{\circ}C$ to $40^{\circ}C$	-	-	220	$\mu A$
Chip Deselect to Data Retention Time	$t_{CDR}$	See Retention Waveform	0	-	-	ns
Operation Recovery Time	$t_R$	See Retention Waveform	5	-	-	ms

Notes (1) Typical figures are measured at 25°C.

(2) This parameter is guaranteed not tested.

**AC OPERATING CONDITIONS****Read Cycle**

<i>Parameter</i>	<i>Symbol</i>	<i>-85</i>		<i>-10</i>		<i>-12</i>		<i>Unit</i>
		<i>min</i>	<i>max</i>	<i>min</i>	<i>max</i>	<i>min</i>	<i>max</i>	
Read Cycle Time	$t_{RC}$	85	-	100	-	120	-	ns
Address Access Time	$t_{AA}$	-	85	-	100	-	120	ns
Chip Select Access Time	$t_{ACS}$	-	85	-	100	-	120	ns
Output Enable to Output Valid	$t_{OE}$	-	45	-	50	-	60	ns
Output Hold from Address Change	$t_{OH}$	10	-	10	-	10	-	ns
Chip Selection to Output in Low Z	$t_{CLZ}$	10	-	10	-	10	-	ns
Output Enable to Output in Low Z	$t_{OLZ}$	5	-	5	-	5	-	ns
Chip Deselection to O/P in High Z	$t_{CHZ}$	0	30	0	35	0	45	ns
Output Disable to Output in High Z	$t_{OHZ}$	0	30	0	35	0	45	ns

**Write Cycle**

<i>Parameter</i>	<i>Symbol</i>	<i>-85</i>		<i>-10</i>		<i>-12</i>		<i>Unit</i>
		<i>min</i>	<i>max</i>	<i>min</i>	<i>max</i>	<i>min</i>	<i>max</i>	
Write Cycle Time	$t_{WC}$	85	-	100	-	120	-	ns
Chip Selection to End of Write	$t_{CW}$	75	-	80	-	100	-	ns
Address Valid to End of Write	$t_{AW}$	75	-	80	-	100	-	ns
Address Setup Time	$t_{AS}$	0	-	0	-	0	-	ns
Write Pulse Width	$t_{WP}$	55	-	60	-	70	-	ns
Write Recovery Time	$t_{WR}$	3	-	3	-	3	-	ns
Write to Output in High Z	$t_{WHZ}$	0	30	0	35	0	40	ns
Data to Write Time Overlap	$t_{DW}$	35	-	40	-	45	-	ns
Data Hold from Write Time	$t_{DH}$	0	-	0	-	0	-	ns
Output active from end of write	$t_{OW}$	5	-	5	-	5	-	ns

**Read Cycle Timing Waveform <sup>(1,2)</sup>**

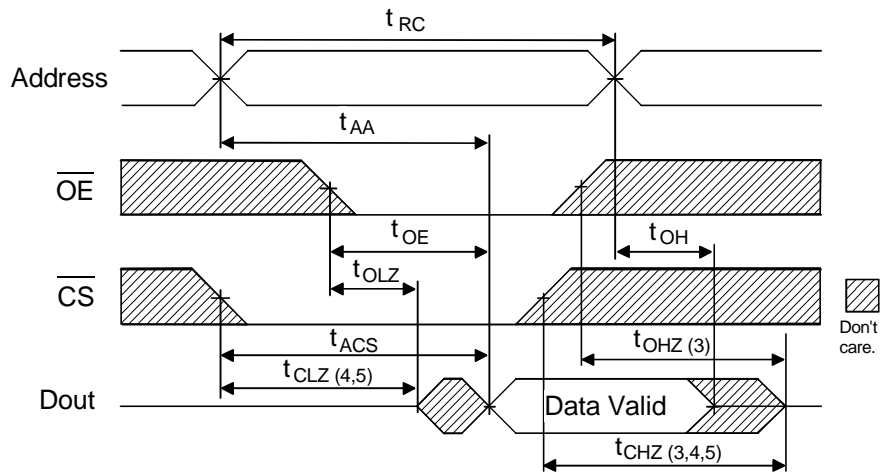

**AC Read Characteristics Notes**

- (1)  $\overline{WE}$  is High for Read Cycle.
- (2) All read cycle timing is referenced from the last valid address to the first transition address.
- (3)  $t_{CHZ}$  and  $t_{OHZ}$  are defined as the time at which the outputs achieve open circuit conditions and are not referenced to output voltage levels.
- (4) At any given temperature and voltage condition,  $t_{CHZ}$  (max) is less than  $t_{CLZ}$  (min) both for a given module and from module to module.
- (5) These parameters are sampled and not 100% tested.

**Write Cycle No.1 Timing Waveform <sup>(1,4)</sup>**

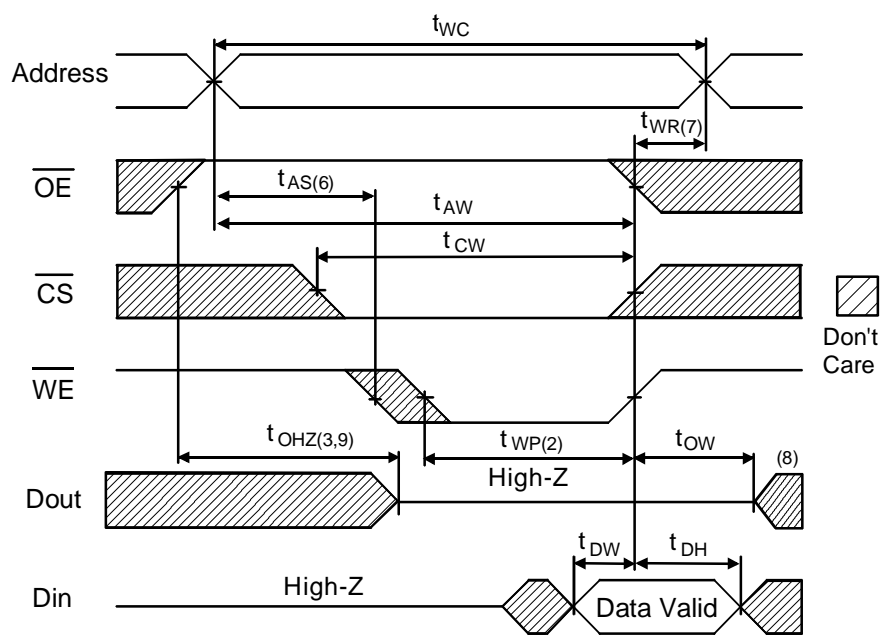

**Write Cycle No.2 Timing Waveform <sup>(1,5)</sup>**

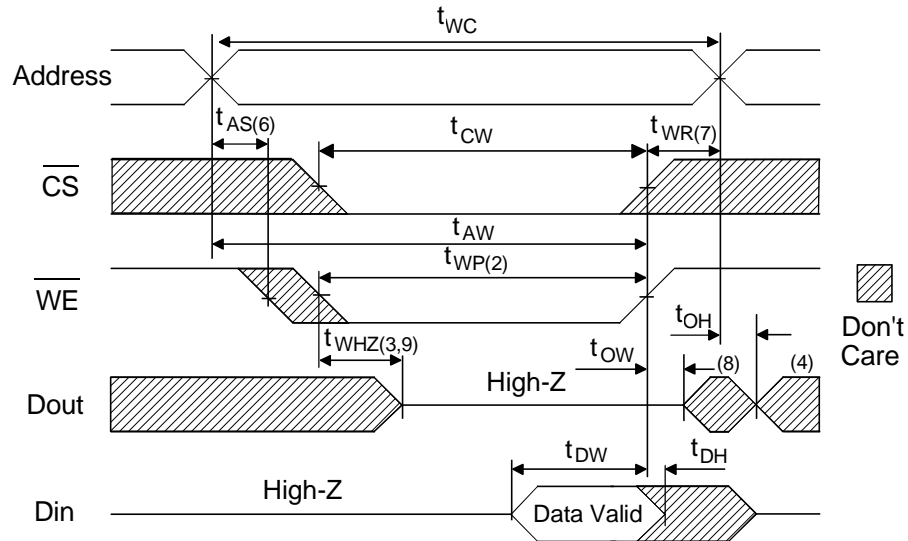

**AC Write Characteristics Notes**

- (1) All write cycle timing is referenced from the last valid address to the first transition address.
- (2) All writes occur during the overlap of  $\overline{CS}$  and  $\overline{WE}$  low.
- (3) If  $\overline{OE}$ ,  $\overline{CS}$ , and  $\overline{WE}$  are in the Read mode during this period, the I/O pins are low impedance state. Inputs of opposite phase to the output must not be applied because bus contention can occur.
- (4) Dout is the Read data of the new address.
- (5)  $\overline{OE}$  is continuously low.
- (6) Address is valid prior to or coincident with  $\overline{CS}$  and  $\overline{WE}$  low, too avoid inadvertant writes.
- (7)  $\overline{CS}$  or  $\overline{WE}$  must be high during address transitions.
- (8) When  $\overline{CS}$  is low : I/O pins are in the output state. Input signals of opposite phase leading to the output should not be applied.
- (9) Defined as the time at which the outputs achieve open circuit conditions and are not referenced to output voltage levels. These parameters are sampled and not 100% tested.

**Data Retention Waveform**

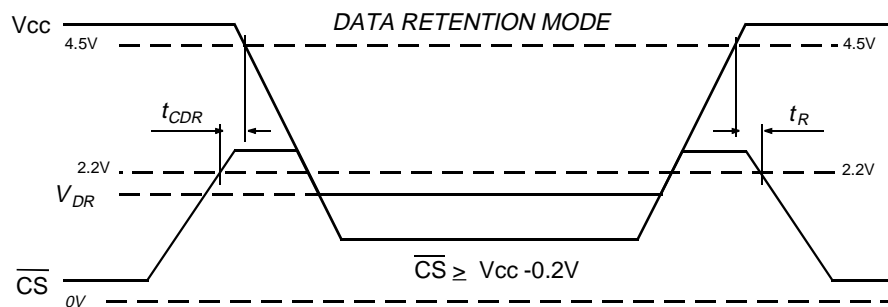

**Package Information**      Dimensions in mm

**Plastic 36 Pin Single-In-Line (SIP)**

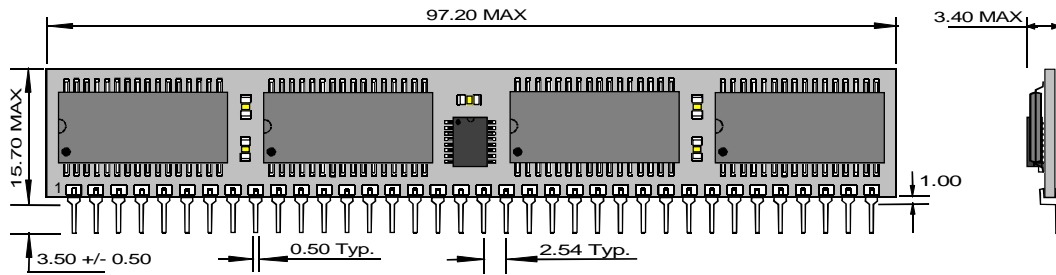

**Ordering Information**

**SYS82000RKXDLI-85**

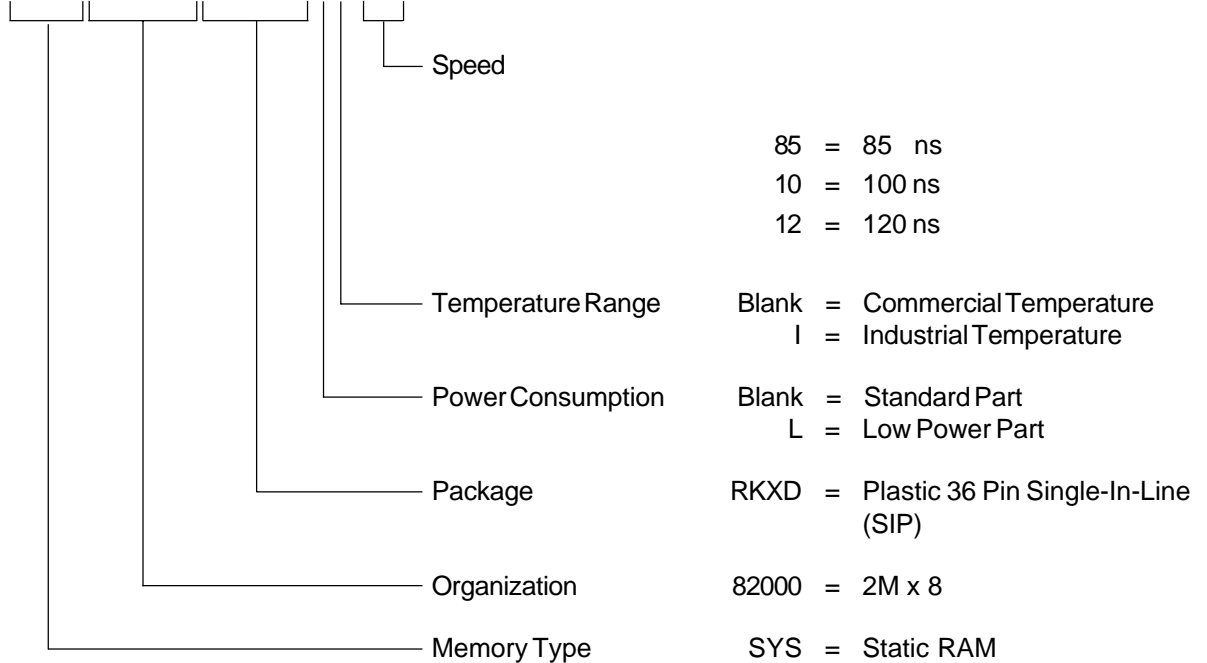

**Note :**

Although this data is believed to be accurate the information contained herein is not intended to and does not create any warranty of merchantability or fitness for a particular purpose. Our products are subject to a constant process of development. Data may be changed without notice. Products are not authorised for use as critical components in life support devices without the express written approval of a company director.