

Product Features

- Integrated Monolithic GaAs MESFET
- Active Mixer Packages Module
- Surface Mount Hybrid Type & Reel Packing
- No matching circuit needed
- Lower Manufacturing Cost
- Higher Productivity and Reliability
- Very Low Noise Figure & Low Distortion
- Pb Free / RoHS Standard

Application

- Repeater
- Base Station
- RF Sub-Systems



Package Type: HY-1

Description

The IC operates from a positive +5V rail consuming 125 mA of current while only requiring a 2 ± 2 dBm LO drive.

The MCM is implemented with reliable and mature GaAs MESFET technology.

Specifications

(Operating Temperature: $-30^{\circ}\text{C} \sim +70^{\circ}\text{C}$)

IF Frequency (MHz)	LO Frequency (MHz)	RF Frequency (MHz)	Conversion Gain (dB)	OIP3 (dBm)	P1dB (dBm)	LO to RF Leakage (dBm)	IF to RF Leakage (dBm)	Vdd/Idd
70	1630-1730	1700-1800	7	26	10	-20	-60	5V/125mA
	1730-1830	1800-1900	4	18	8	-15	-60	5V/125mA

Functional Diagram

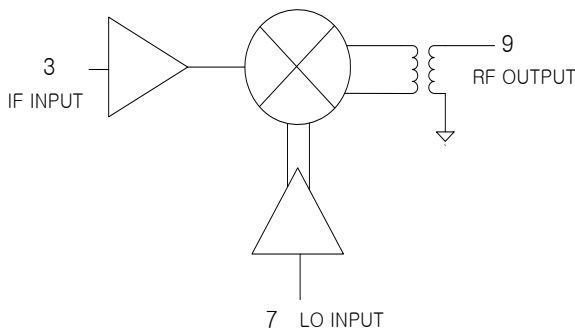

Functional Pin Layout

Pin No.	Function
1 or 5	Vdd+5V
3	IF In
7	LO In
9	RF Out
2,4,6,8,10	Ground

Package Dimensions (Type: HY-1)

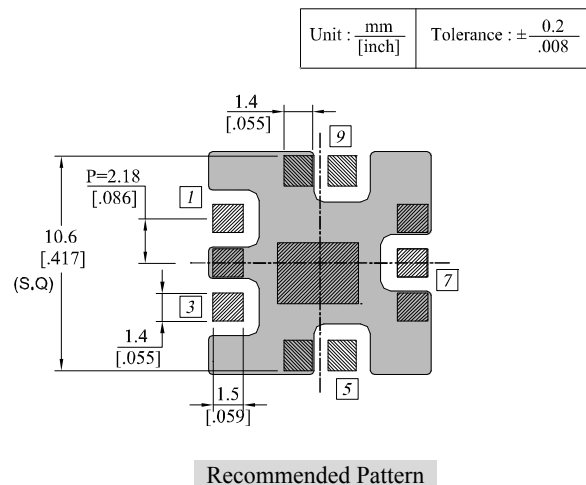
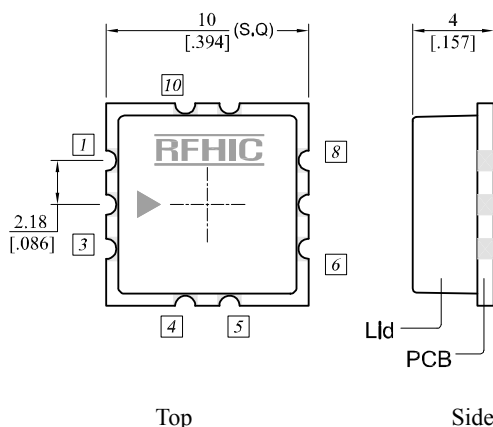

Typical Performance at 25°C

Test Condition: IF = 70MHz@-10dBm, LO = 1630~1830MHz@2dBm, RF = 1700~1900MHz

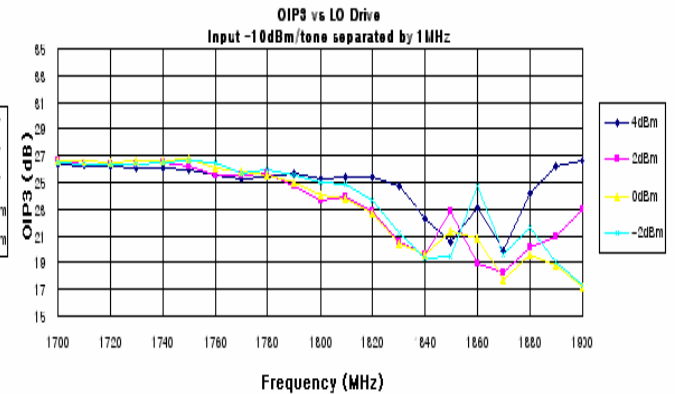
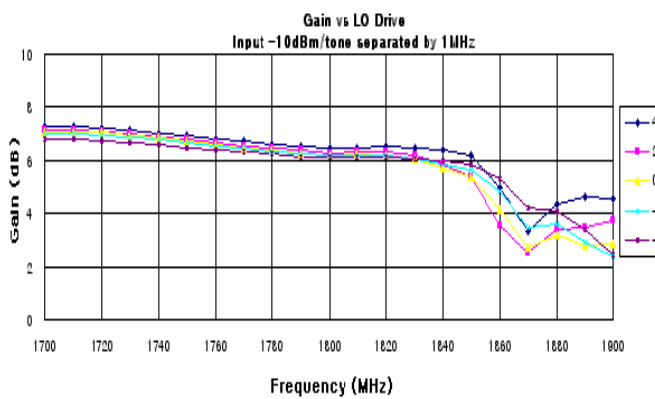
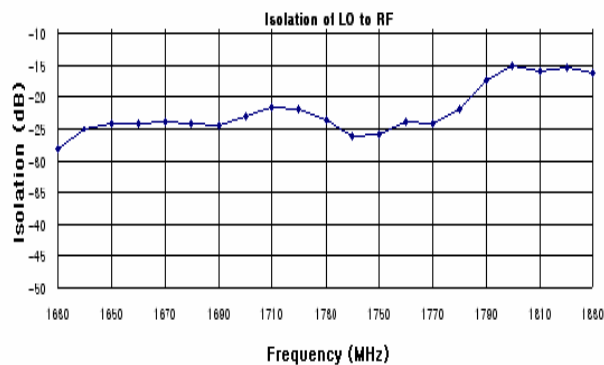
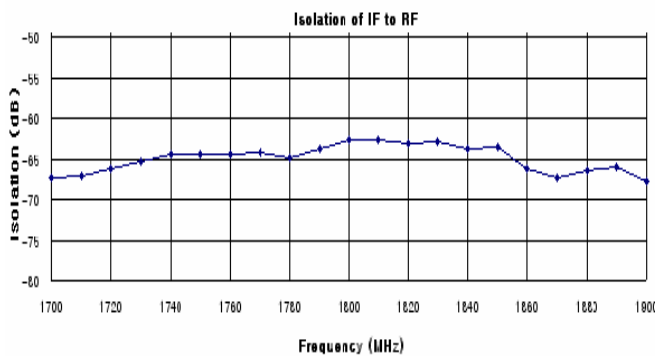
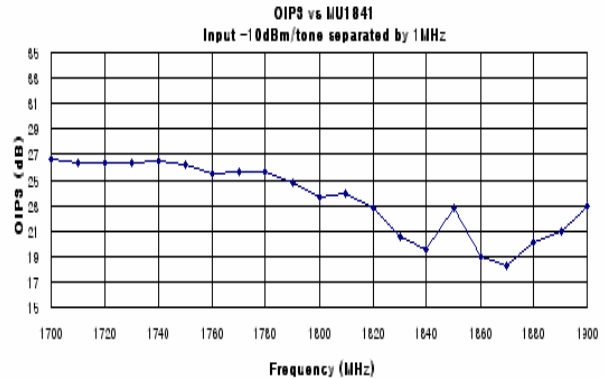
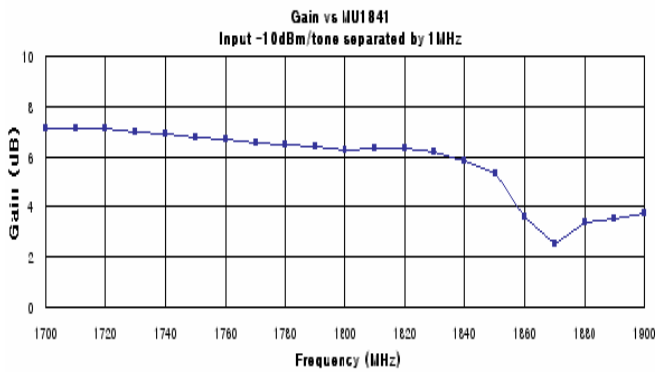

RFHIC Corporation (RFHIC) reserves the right to make changes to any products herein or to discontinue any product at any time without notice. RFHIC do not assume any liability for the suitability of its products for any particular purpose, and disclaims any and all liability, including without limitation consequential or incidental damages. The product specifications herein expressed have been carefully checked and are assumed to be reliable. However, RFHIC disclaims liability for inaccuracies and strongly recommends buyers to verify that the information they are using is current before placing purchase orders. RFHIC products are not intended for use in life support equipment or application where malfunction of the product can be expected to result in personal injury or death. Buyer uses or sells such products for any such unintended or unauthorized application, buyer shall indemnify, protect and hold RFHIC and its directors, officers, stockholders, employees, representatives and distributors harmless against any and all claims arising out of such use. RFHIC's liability under or arising out of damages, claims of whatsoever kind and nature which RFHIC products could cause shall be limited in amount to the net purchase price of the products sold to buyer by RFHIC.