

Features

- Wide operating voltage range
 - VDD: 4.5~5.5V
- Low power consumption
 - Operation: 5mA max.
 - Standby: 2 μ A max.
- User selectable internal organization
 - 1K (HT24C01): 128 \times 8
 - 2K (HT24C02): 256 \times 8
 - 4K (HT24C04): 512 \times 8
- Two-wire Serial Interface
- Automatic erase-before-write operation
- 8-byte Page (1K/2K), 16-byte Page (4K) Write Modes
- Write operation with built-in timer
- Software and hardware controlled write protection
- 40-years data retention
- 10⁶ rewrite cycles per word
- Operating temperature range: -40°C~+85°C
- 8-pin DIP/SOP package

General Description

The HT24C01/02/04 is a 1K/2K/4K-bit serial read/write non-volatile memory device using the CMOS floating gate process. Its 1024/2048/4096 bits of memory are organized into 128/256/512 words and each word is 8 bits. The device is optimized for use in many industrial and commercial applications where low

power and low voltage operation are essential. Up to eight 24C01 or 24C02 devices and up to four 24C04 devices may be connected to the same two wire bus. The HT24C01/02/04 is guaranteed for 1M erase/write cycles and 40 year data retention.

Pin Assignment

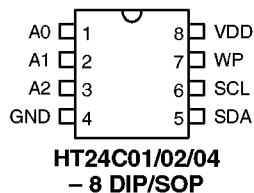

Block Diagram

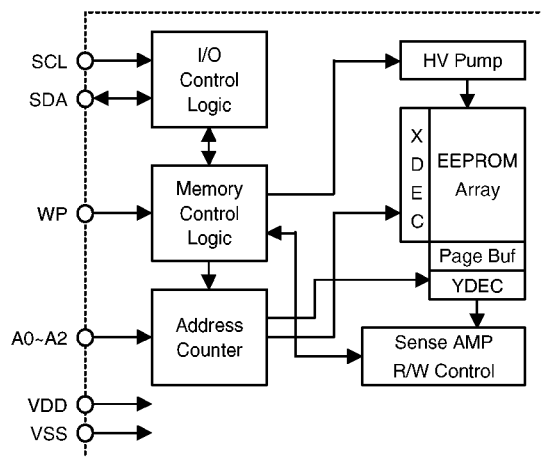

Pin Description

Pin Name	I/O	Description
A0~A2	I	Address input
SDA	I/O	Serial data
SCL	I	Serial clock input
WP	I	Write protect
VSS	I	Negative power supply
NC	—	No connection
VDD	I	Positive power supply

Absolute Maximum Ratings*

Supply Voltage -0.3V to 6.0V Input Voltage $V_{SS}-0.3$ to $V_{DD}+0.3$
 Storage Temperature -50°C to 125°C Operating Temperature -40°C to 85°C

*Note: Stresses above those listed under “Absolute Maximum Ratings” may cause permanent damage to the device. These are stress ratings only. Functional operation of this device at these or any other conditions above those indicated in the operational sections of this specification is not implied and exposure to absolute maximum rating conditions for extended periods may affect device reliability.

D.C. Characteristics

(Ta=-40°C to 85°C)

Symbol	Parameter	Test Conditions		Min.	Typ.	Max.	Unit
		VDD	Conditions				
VDD	Operating Voltage	—	—	4.5	—	5.5	V
I _{DD1}	Operating Current	5V	Read at 100kHz	—	—	2	mA
I _{DD2}	Operating Current	5V	Write at 100kHz	—	—	5	mA
V _{IL}	Input Low Voltage	—	—	-1	—	0.3V _{DD}	V
V _{IH}	Input High Voltage	—	—	0.7V _{DD}	—	V _{DD} +0.5	V
V _{OL}	Output Low Voltage	5V	I _{OL} =2.1mA	—	—	0.4	V
I _{LI}	Input Leakage Current	5V	V _{IN} =0 or V _{DD}	—	—	1	μA
I _{LO}	Output Leakage Current	5V	V _{OUT} =0 or V _{DD}	—	—	1	μA
I _{STB}	Standby Current	5V	V _{IN} =0 or V _{DD}	—	—	2	μA
C _{IN}	Input Capacitance (see Note)	—	f=1MHz 25°C	—	—	6	pF
C _{OUT}	Output Capacitance (see Note)	—	f=1MHz 25°C	—	—	8	pF

Note: These parameters are periodically sampled but not 100% tested

A.C. Characteristics

(Ta=-40°C to 85°C)

Symbol	Parameter	Remark	Min.	Max.	Unit
f _{SK}	Clock Frequency		—	400	kHz
t _{HIGH}	Clock High Time		600	—	ns
t _{LOW}	Clock Low Time		1300	—	ns
t _R	SDA & SCL Rise Time	Note	—	300	ns
t _F	SDA & SCL Fall Time	Note	—	300	ns
t _{HD:STA}	START Condition Hold Time	After this period the first clock pulse is generated	600	—	ns
t _{SU:STA}	START Condition Setup Time	Only relevant for repeated START condition	600	—	ns
t _{HD:DAT}	Data Input Hold Time		0	—	ns
t _{SU:DAT}	Data Input Setup Time		100	—	ns
t _{SU:STO}	STOP Condition Setup Time		600	—	ns
t _{AA}	Output Valid from Clock		—	900	ns
t _{BUF}	Bus Free Time	Time the bus must be free before a new transmission can start	1300	—	ns
t _{SP}	Input Filter Time Constant (SDA & SCL pins)	Noise suppression time	—	50	ns
t _{WR}	Write Cycle Time		—	10	ms

Note: Not 100% tested.

Timing Diagrams

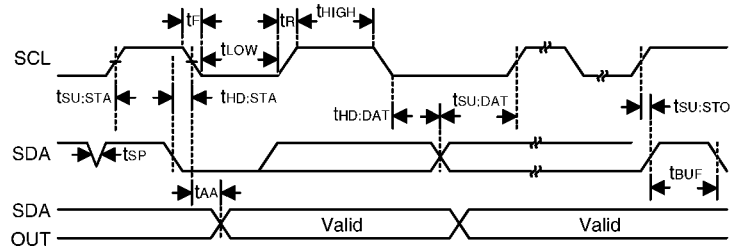

Functional Description

- **Serial clock (SCL)**
The SCL input used to positive edge clock data into each EEPROM device and negative edge clock data out of each device.
- **Serial data (SDA)**
The SDA pin is bi-directional for serial data transfer. The pin is open-drain driven and may be write-ORed with any number of other open-drain or open collector devices.
- **A0, A1, A2**
The A2, A1 and A0 pins are device address inputs that are hard wired for the HT24C01/02. As many as eight 1K/2K devices may be addressed on a single bus system (device addressing is discussed in detail under the Device Addressing section). The HT24C04 uses the A2 and A1 inputs for hard wire addressing and a total of four 4K devices may be addressed on a single bus system. The A0 pin is no connect.
- **Write protect (WP)**
The HT24C01/02/04 has a Write Protect pin that provides hardware data protection. The Write Protect pin allows normal read/write operations when connection ground. When the Write Protect pin is connected to V_{DD}, the write protection feature is enable and operates as shown in the following table.

	HT24C01	HT24C02	HT24C04
Organization	128×8	256×8	512×8
WP pin status	At V _{DD}	At V _{DD}	At V _{DD}
Protect array	Full (1K) Array	Full (2K) Array	Upper Half (2K) Array

Memory Organization

- **HT24C01, 1K SERIAL EEPROM**
Internally organized with 128 eight-bit words, the 1K requires a seven-bit data word address for random word addressing.
- **HT24C02, 2K SERIAL EEPROM**
Internally organized with 256 eight-bit words, the 2K requires a eight-bit data word address for random word addressing.
- **HT24C04, 4K SERIAL EEPROM**
Internally organized with two blocks of 256 eight-bit words. Random word addressing requires a nine-bit data word address.

Device Operations

- **Clock and data transition**
Data transfer may be initiated only when the bus is not busy. During data transfer, the data line must remain stable whenever the clock line is HIGH. Changes in data line while the clock line is HIGH will be interpreted as a START or STOP condition.
- **Start condition**
A high-to-low transition of SDA with SCL high is a start condition which must precede any other command (refer to Start and Stop Definition Timing diagram).
- **Stop condition**
A low-to-high transition of SDA and SCL high is a stop condition. After a read sequence, the stop command will place the EEPROM in a standby power mode (refer to Start and Stop Definition Timing Diagram).
- **Acknowledge**
All addresses and data words are serially transmitted to and from the EEPROM in eight bit words. The EEPROM sends a zero to acknowledge that it has received each word. This happens during the ninth clock cycle.

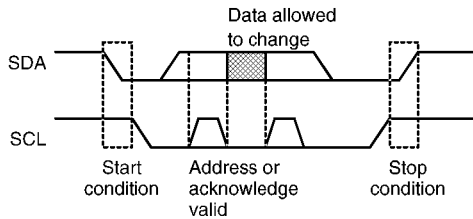

Device Addressing

The 1K, 2K and 4K EEPROM devices all require an eight-bit device address word following a start condition to enable the chip for a read or write operation. The device address word consist of a mandatory one, zero sequence for the first four most significant bits as shown. This is common to all the EEPROM device.

The next three bits are the A2, A1 and A0 device address bits for the 1K/2K EEPROM. These three bits must compare to their corresponding hard-wired input pins.

The 4K EEPROM only use the A2 and A1 device address bits with the third bit being a memory page address bit. The two device address bits must compare to their corresponding hard-wired input pins. The A0 pin is no connect.

The eighth bit of device address is the read/write operation select bit. A read operation is initiated if this bit is high and a write operation is initiated if this bit is low.

Upon a compare of the device address, the EEPROM will output a zero. If a compare is not a made, the chip will return to a standby state.

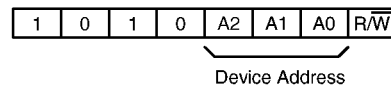

Write Operations

- **Byte write**
A write operation requires an eight-bit data word address following the device address word and acknowledgement. Upon receipt of this address, the EEPROM will again respond with a zero and then clock in the first eight-bit data word. Following receipt of the eight-bit data word, the EEPROM will output a zero and the addressing device, such as a microcontroller, must terminate the write sequence with a stop condition. At this time the EEPROM enters an internally-timed write cycle to the nonvolatile memory. All inputs are disable during this write cycle and EEPROM will not respond until the write is complete.

Byte write timing

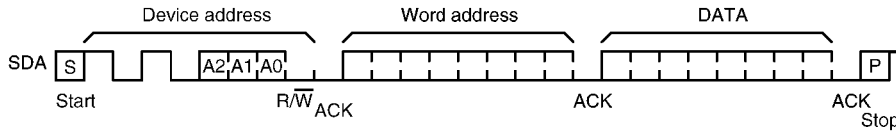

• Page write

The 1K/2K EEPROM is capable of an eight-byte page write, and the 4K device is capable of sixteen-byte page writes.

A page write is initiated the same as byte write, but the microcontroller does not send a stop condition after the first data word is clocked in. Instead, after the EEPROM acknowledges receipt of the first data word, the microcontroller can transmit up to seven (1K/2K) or fifteen (4K) more data words. The EEPROM will respond with a zero after each data word received. The microcontroller must terminate the page write sequence with a stop condition.

Page write timing

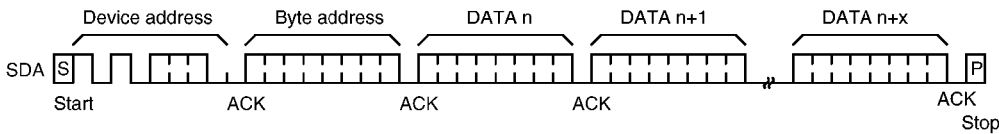

The data word address lower three (1K/2K) or four (4K) bits are internally increment following the receipt of each data word. The higher data word address bits are not incremented, retaining the memory page row location. If more than eight (1K/2K) or sixteen (4K) data words are transmitted to the EEPROM, the data word address will roll over and previous data will be overwritten.

• Acknowledge polling

Since the device will not acknowledge during a write cycle, this can be used to determine when the cycle is complete (this feature can be used to maximize bus throughput). Once the stop condition for a write command has an issued from the master, the device initiates the internally timed write cycle. ACK polling can be initiated immediately. The involves the master sending a start condition followed by the control byte for a write command (R/W=0). If the device is still busy with the write cycle, then no ACK will be returned. If the cycle is complete, then the device will return the ACK and master can then proceed with the next read or write command.

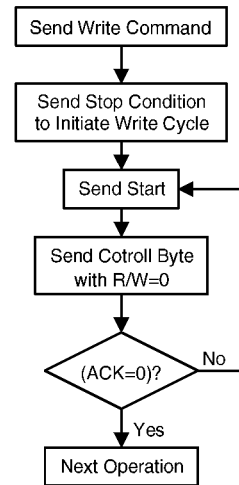

Acknowledge Polling Flow

- Write protection

The HT24C01/02 can be used as a serial ROM when the WP pin is connected to VDD . Programming will be inhibited and the entire memory will be write-protected. If the WP pin of the HT24C04 is connected to VDD, programming of the upper half of the memory will not take place.

- Read operations

Read operations are initiated the same way as write operations with the exception that the read/write select bit in the device address word is set to one. There are three read operations: current address read, random address read and sequential read.

- Current address read

The internal data word address counter maintains the last address accessed during the last read or write operation, incremented by one. This address stays valid between operations as long as the chip power is maintained. The address roll over during read is from the last byte of the last memory page to the first byte of the first page. The address roll over during write from the last byte of the current page to the first byte of the same page. Once the device address with the read/write select bit set to one is clocked in and acknowledged by the EEPROM, the current address data word is serially clocked out. The microcontroller does not respond with an input zero but does generate a following stop condition.

Current read timing

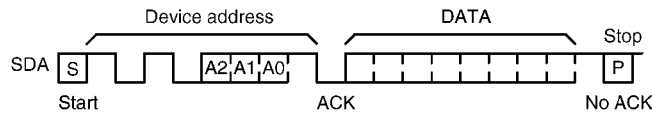

- Random read

A random read requires a dummy byte write sequence to load in the data word address are clocked in and acknowledged by the EEPROM, the microcontroller must generate another start condition. The microcontroller now initiates a current address read by sending a device address with the read/write select bit high. The EEPROM acknowledges the device address and serially clocks out the data word. The microcontroller does not respond with a zero but does generate a following stop condition.

Random read timing

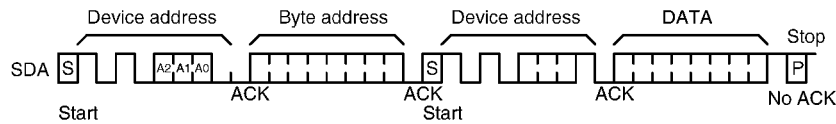

• Sequential read

Sequential reads are initiated by either a current address read or a random address read. After the microcontroller receives a data word, it responds with an acknowledge. As long as the EEPROM receives an acknowledge, it will continue to increment the data word address and serially clock out sequential data words. When the memory address limit is reached, the data word address will roll over and the sequential read continue. The sequential read operation is terminated when the microcontroller does not respond with a zero but dos generate a following stop condition.

Sequential read timing

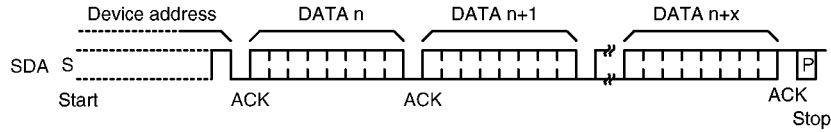

Note:

In all modes, the address pointer will not increment through a block (256 byte) boundary, but will rotate to back to the first location in that block. A "block" is defined as a continuous area of memory with distinct boundaries. The address pointer can not cross the boundary from one to another. It will however, wrap around from the end of a block. The 24C04 has two block, 256 bytes each. The 24C01/02 each have only one block.

Characteristic Curves

