

General Purpose Transistors

PNP Silicon

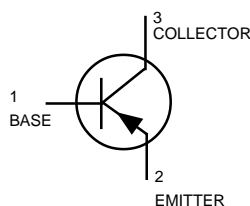

BC856ALT1, BLT1
BC857ALT1, BLT1
BC858ALT1, BLT1
CLT1

MAXIMUM RATINGS

Rating	Symbol	BC856	BC857	BC858	Unit
Collector–Emitter Voltage	V_{CEO}	–65	–45	–30	V
Collector–Base Voltage	V_{CBO}	–80	–50	–30	V
Emitter–Base Voltage	V_{EBO}	–5.0	–5.0	–5.0	V
Collector Current — Continuous	I_C	–100	–100	–100	mAdc

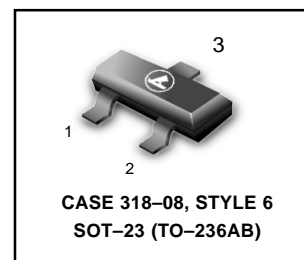

THERMAL CHARACTERISTICS

Characteristic	Symbol	Max	Unit
Total Device Dissipation FR– 5 Board, (1) $T_A = 25^\circ\text{C}$	P_D	225	mW
Derate above 25°C		1.8	mW/ $^\circ\text{C}$
Thermal Resistance, Junction to Ambient	$R_{\theta JA}$	556	$^\circ\text{C}/\text{W}$
Total Device Dissipation Alumina Substrate, (2) $T_A = 25^\circ\text{C}$	P_D	300	mW
Derate above 25°C		2.4	mW/ $^\circ\text{C}$
Thermal Resistance, Junction to Ambient	$R_{\theta JA}$	417	$^\circ\text{C}/\text{W}$
Junction and Storage Temperature	T_J, T_{stg}	–55 to +150	$^\circ\text{C}$

DEVICE MARKING

BC856ALT1 = 3A; BC856BLT1 = 3B; BC857ALT1 = 3E; BC857BLT1 = 3F;
 BC858ALT1 = 3J; BC858BLT1 = 3K; BC858CLT1 = 3L

ELECTRICAL CHARACTERISTICS ($T_A = 25^\circ\text{C}$ unless otherwise noted.)

Characteristic	Symbol	Min	Typ	Max	Unit
----------------	--------	-----	-----	-----	------

OFF CHARACTERISTICS

Collector–Emitter Breakdown Voltage ($I_C = -10\text{ mA}$)	BC856 Series	– 65	—	—	
	BC857 Series	$V_{(BR)CEO}$	– 45	—	v
	BC858 Series	– 30	—	—	
Collector–Emitter Breakdown Voltage ($I_C = -10\ \mu\text{A}, V_{EB} = 0$)	BC856 Series	– 80	—	—	
	BC857 Series	$V_{(BR)CES}$	– 50	—	v
	BC858 Series	– 30	—	—	
Collector–Base Breakdown Voltage ($I_C = -10\ \mu\text{A}$)	BC856 Series	– 80	—	—	
	BC857 Series	$V_{(BR)CBO}$	– 50	—	v
	BC858 Series	– 30	—	—	
Emitter–Base Breakdown Voltage ($I_E = -1.0\ \mu\text{A}$)	BC856 Series	– 5.0	—	—	
	BC857 Series,	$V_{(BR)EBO}$	– 5.0	—	v
	BC858 Series	– 5.0	—	—	
Collector Cutoff Current ($V_{CB} = -30\text{ V}$) ($V_{CB} = -30\text{ V}, T_A = 150^\circ\text{C}$)		I_{CBO}	—	– 15	nA
			—	– 4.0	μA

1. FR–5 = 1.0 x 0.75 x 0.062in

2. Alumina = 0.4 x 0.3 x 0.024 in. 99.5% alumina.

BC856ALT1, BLT1 BC857ALT1, BLT1 BC858ALT1, BLT1, CLT1

ELECTRICAL CHARACTERISTICS ($T_A = 25^\circ\text{C}$ unless otherwise noted) (Continued)

Characteristic	Symbol	Min	Typ	Max	Unit
----------------	--------	-----	-----	-----	------

ON CHARACTERISTICS

DC Current Gain ($I_C = -10\ \mu\text{A}$, $V_{CE} = -5.0\ \text{V}$)	BC856A, BC857A, BC858A BC856B, BC857B, BC858B BC858C,	h_{FE}	—	90	—	—
($I_C = -2.0\ \text{mA}$, $V_{CE} = -5.0\ \text{V}$)	BC856A, BC857A, BC858A BC856B, BC857B, BC858B BC858C		125	180	250	
Collector–Emitter Saturation Voltage ($I_C = -10\ \text{mA}$, $I_B = -0.5\ \text{mA}$) ($I_C = -100\ \text{mA}$, $I_B = -5.0\ \text{mA}$)		$V_{CE(sat)}$	—	—	-0.3 -0.65	V
Base–Emitter Saturation Voltage ($I_C = -10\ \text{mA}$, $I_B = -0.5\ \text{mA}$) ($I_C = -100\ \text{mA}$, $I_B = -5.0\ \text{mA}$)		$V_{BE(sat)}$	—	-0.7 -0.9	—	V
Base–Emitter on Voltage ($I_C = -2.0\ \text{mA}$, $V_{CE} = -5.0\ \text{V}$) ($I_C = -10\ \text{mA}$, $V_{CE} = -5.0\ \text{V}$)		$V_{BE(on)}$	-0.6	—	-0.75 -0.82	V

SMALL–SIGNAL CHARACTERISTICS

Current–Gain — Bandwidth Product ($I_C = -10\ \text{mA}$, $V_{CE} = -5.0\ \text{Vdc}$, $f = 100\ \text{MHz}$)		f_T	100	—	—	MHz
Output Capacitance ($V_{CB} = -10\ \text{V}$, $f = 1.0\ \text{MHz}$)		C_{ob}	—	—	4.5	pF
Noise Figure ($I_C = -0.2\ \text{mA}$, $V_{CE} = -5.0\ \text{Vdc}$, $R_S = 2.0\ \text{k}\Omega$, $f = 1.0\ \text{kHz}$, $BW = 200\ \text{Hz}$)		NF	—	—	10	dB

BC856ALT1, BLT1 BC857ALT1, BLT1, BC858ALT1, BLT1, CLT1

BC857/BC858

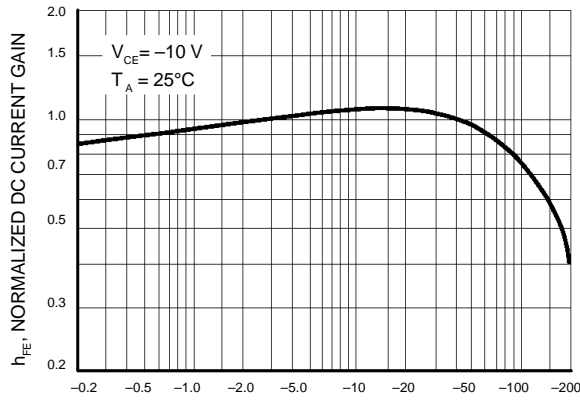

I_C , COLLECTOR CURRENT (mA)
Figure 1. Normalized DC Current Gain

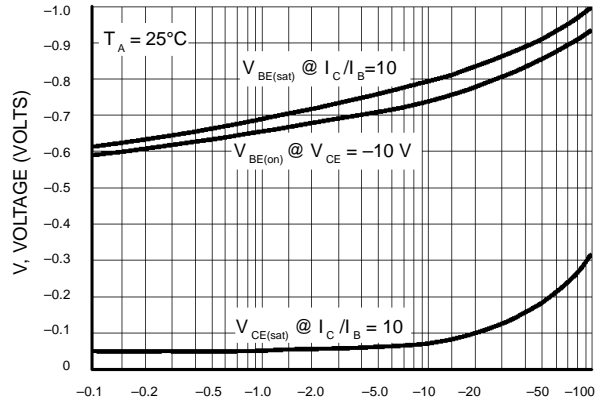

I_C , COLLECTOR CURRENT (mA)
Figure 2. "Saturation" and "On" Voltages

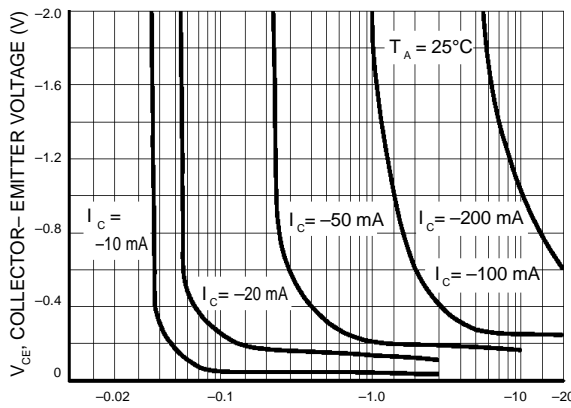

I_B , BASE CURRENT (mA)
Figure 3. Collector Saturation Region

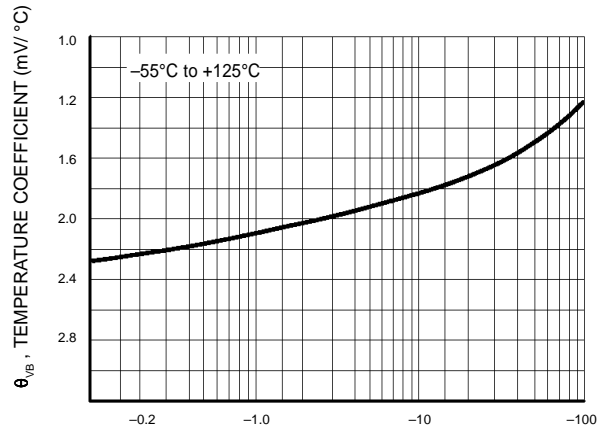

I_C , COLLECTOR CURRENT (mA)
Figure 4. Base-Emitter Temperature Coefficient

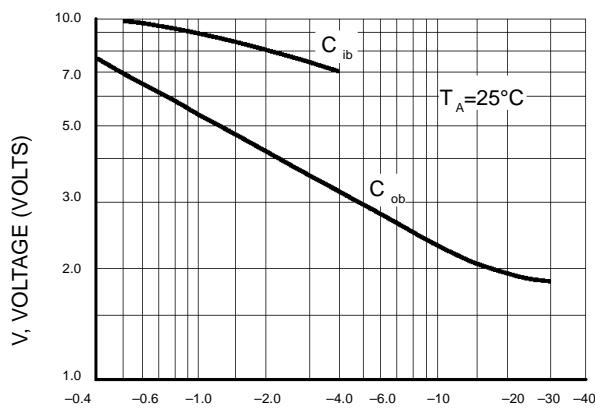

V_R , REVERSE VOLTAGE (VOLTS)
Figure 5. Capacitances

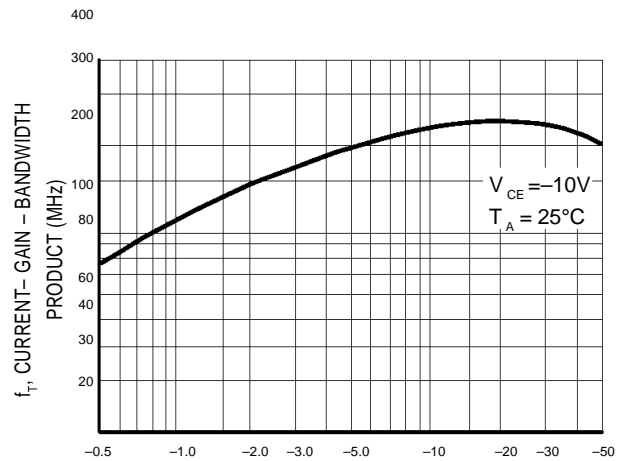

I_C , COLLECTOR CURRENT (mA)
Figure 6. Current-Gain - Bandwidth Product

BC856ALT1, BLT1 BC857ALT1, BLT1, BC858ALT1, BLT1, CLT1

BC856

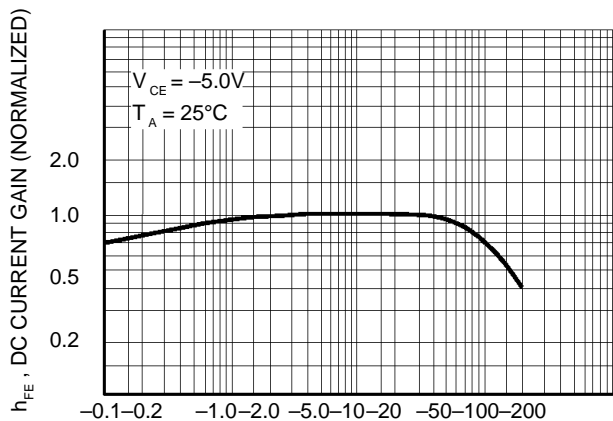

I_C , COLLECTOR CURRENT (mA)
Figure 7. DC Current Gain

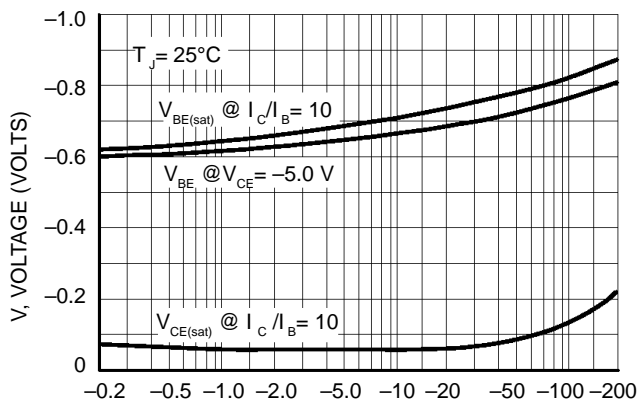

I_C , COLLECTOR CURRENT (mA)
Figure 8. "On" Voltage

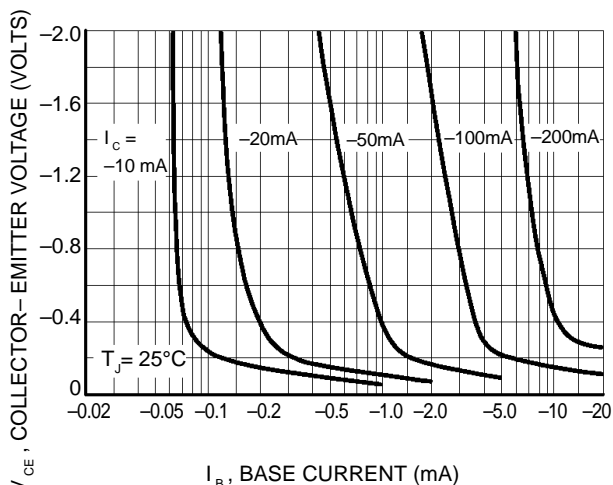

I_B , BASE CURRENT (mA)
Figure 9. Collector Saturation Region

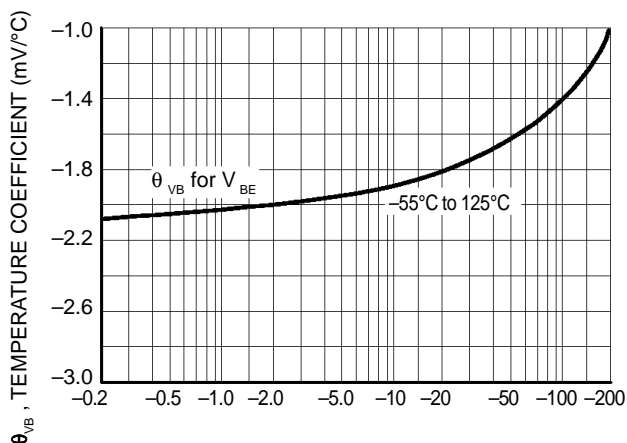

I_C , COLLECTOR CURRENT (mA)
Figure 10. Base-Emitter Temperature Coefficient

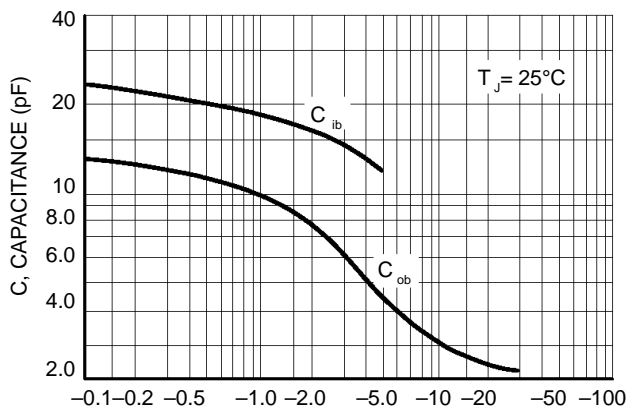

V_R , REVERSE VOLTAGE (VOLTS)
Figure 11. Capacitance

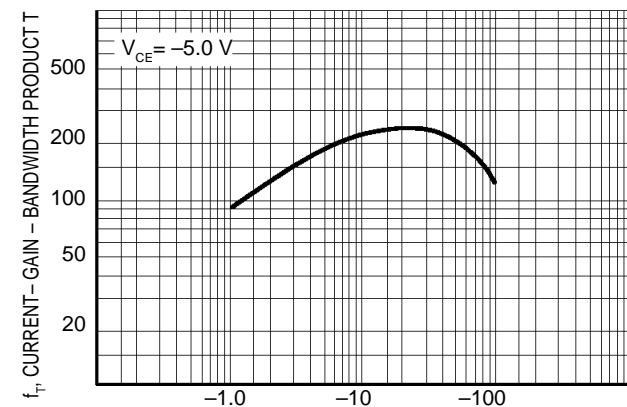

I_C , COLLECTOR CURRENT (mA)
Figure 12. Current-Gain - Bandwidth Product

BC856ALT1, BLT1 BC857ALT1, BLT1, BC858ALT1, BLT1, CLT1

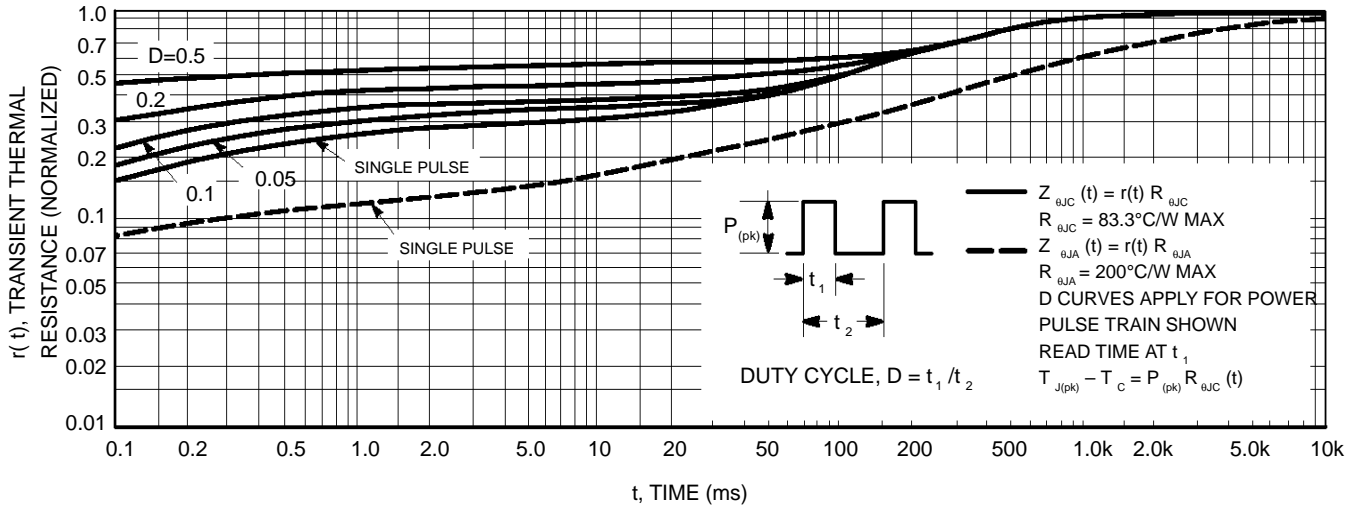

Figure 13. Thermal Response

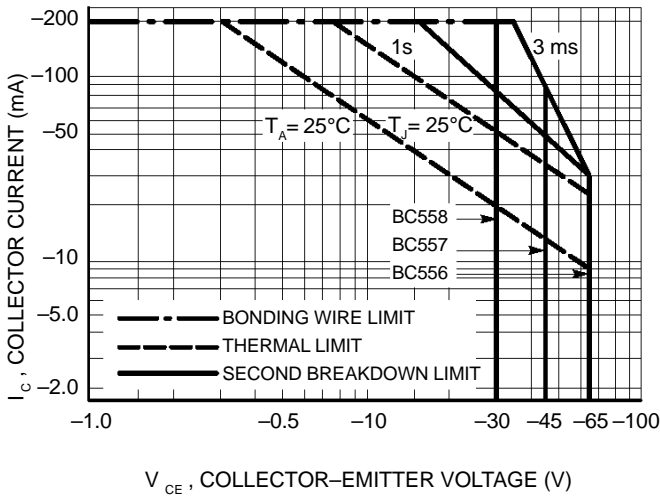

Figure 14. Active Region Safe Operating Area

The safe operating area curves indicate $I_C - V_{CE}$ limits of the transistor that must be observed for reliable operation. Collector load lines for specific circuits must fall below the limits indicated by the applicable curve.

The data of Figure 14 is based upon $T_{J(pk)} = 150^\circ\text{C}$; T_C or T_A is variable depending upon conditions. Pulse curves are valid for duty cycles to 10% provided $T_{J(pk)} \leq 150^\circ\text{C}$. $T_{J(pk)}$ may be calculated from the data in Figure 13. At high case or ambient temperatures, thermal limitations will reduce the power that can be handled to values less than the limitations imposed by the secondary breakdown.