

Lead-Free

SuperFlux LEDs

Introduction

This revolutionary package design allows the lighting designer to reduce the number of LEDs required and provide a more uniform and unique illuminated appearance than with other LED solutions. This is possible through the efficient optical package design and high-current capabilities.

The low profile package can be easily coupled with reflectors or lenses to efficiently distribute light and provide the desired lit appearance. This product family employs red, red-orange and amber LED materials, which allow designers to match the color of many lighting applications like vehicle signal lamps, specialty lighting, and electronic signs.

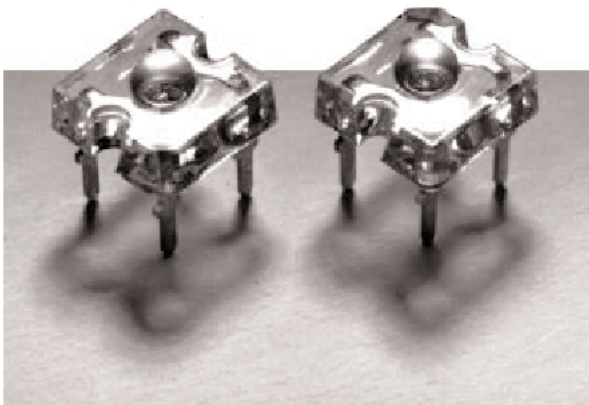

HPWA-MH02
HPWT-MH02
HPWA-DH02
HPWT-DH02
HPWT-RD02
HPWT-BH02
HPWT-MD02
HPWT-RL02
HPWT-DD02
HPWT-ML02
HPWT-BD02
HPWT-DL02
HPWT-RH02
HPWT-BL02



Key Benefits

- ◆ Rugged Lighting Products
- ◆ Electricity Savings
- ◆ Maintenance Savings

Features

- ◆ Lead-Free
- ◆ RoHS Compliant
- ◆ High Luminance
- ◆ Uniform Color
- ◆ Low Power Consumption
- ◆ Low Thermal Resistance
- ◆ Low Profile
- ◆ Meets SAE/ECE/JIS Automotive Color Requirements
- ◆ Packaged in tubes for use with automatic insertion equipment

Typical Applications

- ◆ Automotive Exterior Lighting
- ◆ Electronic Signs and Signals
- ◆ Specialty Lighting

Outline Drawings

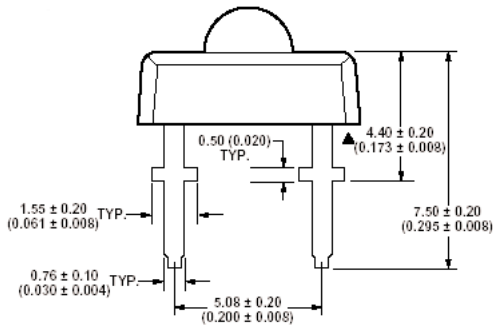
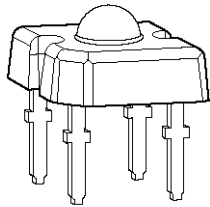
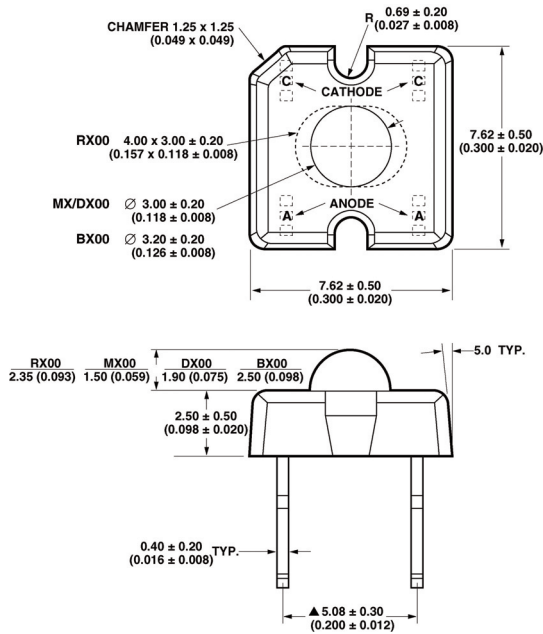

Selection Guide

Table 1

Device Type	LED Color	Total Included	
		Total Flux Φ_v (LM) @ 70 mA ^[1]	Angle θ_{90V} (Degrees) ^[2]
HPWA-MH02	AS AlInGaP Red-Orange	2.0	95
HPWA-DH02			75
HPWT-RD02			44 X 88
HPWT-MD02	TS AlInGaP Red	3.8	100
HPWT-DD02			70
HPWT-BD02			50
HPWT-RH02			44 X 88
HPWT-MH02	TS AlInGaP Red-Orange	5.0	100
HPWT-DH02			70
HPWT-BH02			50
HPWT-RL02			44 X 88
HPWT-ML02	TS AlInGaP Amber	2.5	100
HPWT-DL02			70
HPWT-BL02			50

Notes:

- Φ_v is the total luminous flux output as measured with an integrating sphere after the device has stabilized. ($R_{\theta J-A} = 200^\circ\text{C/W}$, $T_A = 25^\circ\text{C}$)
- $\theta_{0.90V}$ is the included angle at which 90% of the total luminous flux is captured.

Absolute Maximum Ratings at $T_A = 25^\circ\text{C}$

Table 2

Parameter	HPWA	HPWT	Units
DC Forward Current ^[1]	70	70	mA
Power Dissipation	187	221	mW
Reverse Voltage (IR = 100 mA)	10	10	V
Operating Temperature Range	-40 to +100		°C
Storage Temperature Range	-55 to +100		°C
High Temperature Chamber	125°C, 2 Hours		
LED Junction Temperature	125°C		
Solder Conditions ^[2]			
Preheat Temperature	85 +/- 15°C, 70 sec +/- 20 sec		
Solder Temperature	250 +/- 5°C, 2.5 +/- 0.5 sec		
	[1.5mm (0.06 in) below seating plane]		

Notes:

- De-rate as shown in Figures 4a and 4b.
- See "Recommended Soldering Conditions", Page 8.

Optical Characteristics at

$T_A = 25^\circ\text{C}$, $I_F = 70\text{ mA}$,

$R_{\theta\text{J-A}} = 200^\circ\text{C/W}$

Table 3

Device Type	Peak Wavelength	Dominant Wavelength	Total Included Angle	Luminous Intensity/ Total Flux	Viewing Angle
	$\lambda_{\text{peak}}(\text{nm})$ Typ.	$\lambda_{\text{dom}}(\text{nm})^{(1)}$ Typ.	$\theta_{0.90\text{V}}$ (Degrees) ⁽²⁾ Typ.	$I_v(\text{cd})/\Phi_v(\text{lm})$ Typ.	(Degrees) Typ.
HPWA-MH02	624	618	95	0.6	90
HPWA-DH02			75	0.9	60
HPWT-RD02			44 X 88	1.25	25 x 68
HPWT-MD02	640	630	100	0.6	70
HPWT-DD02			70	1.5	40
HPWT-BD02			50	2.0	30
HPWT-RH02			44 X 88	1.25	25 x 68
HPWT-MH02	626	620	100	0.6	70
HPWT-DH02			70	1.5	40
HPWT-BH02			50	2.0	30
HPWT-RL02			44 X 88	1.25	25 x 68
HPWT-ML02	596	594	100	0.6	70
HPWT-DL02			70	1.5	40
HPWT-BL02			50	2.0	30

Notes:

1. The dominant wavelength is derived from the CIE Chromaticity Diagram and represents the perceived color of the device.
2. $\theta_{0.90\text{V}}$ is the included angle at which 90% of the total luminous flux is captured.

Electrical Characteristics at $T_A=25^\circ\text{C}$

Table 4

Device Type	Forward Voltage V_F (Volts) @ $I_F = 70\text{mA}$ (HPWA, HPWT)			Reverse Breakdown V_R (Volts) ⁽¹⁾ @ $I_R = 100$ μA		Capacitance C (pF) $V_F = 0$, F = 1MHz.	Thermal Resistance $R_{\theta\text{J-PIN}}$ ($^\circ\text{C/W}$)	Speed of Response τ_s (ns) ⁽²⁾
	Min	Typ	Max	Min	Typ.	Typ.	Typ.	Typ.
HPWA-xH02	1.83	2.2	2.67	10	20	40	155	20
HPWT-xD02	2.19	2.6	3.03	10	20	40	125	20
HPWT-xH02	2.19	2.6	3.03	10	20	40	125	20
HPWT-xL02	2.19	2.6	3.15	10	20	40	125	20

Notes:

1. Operation in reverse bias is not recommended.
2. τ_s is the time constant, e^{-1/τ_s} .

Part Number Selection

Red

Part Number	Viewing Angle $2\theta^{1/2}$ (Degrees)	Min. Flux ⁽¹⁾ Φ_v (lm)	Max Flux Φ_v (lm)	Minimum Intensity (cd)	Maximum Intensity (cd)
HPWT-RD02-00000	25 X 68	1.5		1.9	
HPWT-RD02-D4000	25 X 68	2.0	4.8	2.5	6.0
HPWT-RD02-E4000	25 X 68	2.5	6.1	3.1	7.6
HPWT-RD02-F4000	25 X 68	3.0	7.3	3.8	9.1
HPWT-BD02-00000	30	1.5		3.0	
HPWT-BD02-D4000	30	2.0	4.8	4.0	9.6
HPWT-BD02-E4000	30	2.5	6.1	5.0	12.2
HPWT-BD02-F4000	30	3.0	7.3	6.0	14.6
HPWT-DD02-00000	40	1.5		2.3	
HPWT-DD02-D4000	40	2.0	4.8	3.0	7.2
HPWT-DD02-E4000	40	2.5	6.1	3.8	9.2
HPWT-DD02-F4000	40	3.0	7.3	4.5	11.0
HPWT-MD02-00000	70	1.5		0.9	
HPWT-MD02-D4000	70	2.0	4.8	1.2	2.9
HPWT-MD02-E4000	70	2.5	6.1	1.5	3.7
HPWT-MD02-F4000	70	3.0	7.3	1.8	4.4

Note:

1. Φ_v is the total luminous flux output as measured with an integrating sphere after the device has stabilized.

Red-Orange

Part Number	Viewing Angle $2\theta^{1/2}$ (Degrees)	Min. Flux Φ_v (lm)	Max Flux Φ_v (lm)	Minimum Intensity (cd)	Maximum Intensity (cd)
HPWT-RH02-00000	25 X 68	1.5		1.9	
HPWT-RH02-D4000	25 X 68	2.0	4.8	2.5	6.0
HPWT-RH02-E4000	25 X 68	2.5	6.1	3.1	7.6
HPWT-RH02-F4000	25 X 68	3.0	7.3	3.8	9.1
HPWT-RH02-G4000	25 X 68	3.5	9.7	4.4	12.1
HPWT-RH02-H4000	25 X 68	4.0	12.0	5.0	15.0
HPWT-BH02-00000	30	1.5		3.0	
HPWT-BH02-D4000	30	2.0	4.8	4.0	9.6
HPWT-BH02-E4000	30	2.5	6.1	5.0	12.2
HPWT-BH02-F4000	30	3.0	7.3	6.0	14.6
HPWT-BH02-G4000	30	3.5	9.7	7.0	19.4
HPWT-BH02-H4000	30	4.0	12.0	8.0	24.0
HPWT-DH02-00000	40	1.5		2.3	
HPWT-DH02-D4000	40	2.0	4.8	3.0	7.2
HPWT-DH02-E4000	40	2.5	6.1	3.8	9.2
HPWT-DH02-F4000	40	3.0	7.3	4.5	11.0
HPWT-DH02-G4000	40	3.5	9.7	5.3	14.6
HPWT-DH02-H4000	40	4.0	12.0	6.0	18.0
HPWT-MH02-00000	70	1.5		0.9	
HPWT-MH02-D4000	70	2.0	4.8	1.2	2.9
HPWT-MH02-E4000	70	2.5	6.1	1.5	3.7
HPWT-MH02-F4000	70	3.0	7.3	1.8	4.4
HPWT-MH02-G4000	70	3.5	9.7	2.1	5.8
HPWT-MH02-H4000	70	4.0	12.0	2.4	7.2
HPWA-MH02-B4000	90	1.0	3.6	0.6	2.2
HPWA-DH02-B4000	40	1.0	3.6	1.5	5.4
HPWA-MH02-C4000	90	1.5	4.2	0.9	2.5
HPWA-DH02-C4000	40	1.5	4.2	2.3	6.3

Amber

Part Number	Viewing Angle $2\theta^{1/2}$ (Degrees)	Min. Flux Φ_v (lm)	Max Flux Φ_v (lm)	Minimum Intensity (cd)	Maximum Intensity (cd)
HPWT-RL02-00000	25 X 68	1.0		1.3	
HPWT-RL02-C4000	25 X 68	1.5	4.2	1.9	5.3
HPWT-RL02-D4000	25 X 68	2.0	4.8	2.5	6.0
HPWT-BL02-00000	30	1.0		2.0	
HPWT-BL02-C4000	30	1.5	4.2	3.0	8.4
HPWT-BL02-D4000	30	2.0	4.8	4.0	9.6
HPWT-DL02-00000	40	1.0		1.5	
HPWT-DL02-C4000	40	1.5	4.2	2.3	6.3
HPWT-DL02-D4000	40	2.0	4.8	3.0	7.2
HPWT-ML02-00000	70	1.0		0.6	
HPWT-ML02-C4000	70	1.5	4.2	0.9	2.5
HPWT-ML02-D4000	70	2.0	4.8	1.2	2.9

Figures¹

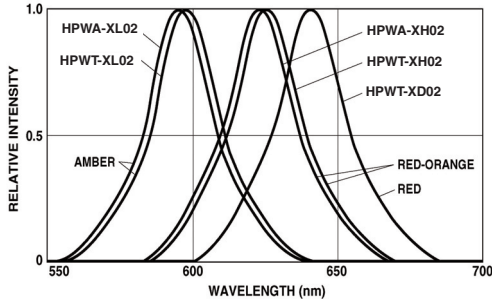

Figure 1a. Relative Intensity vs. Wavelength

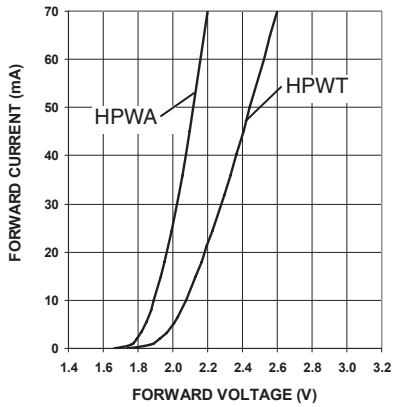

Figure 2a. Forward Current vs. Forward Voltage

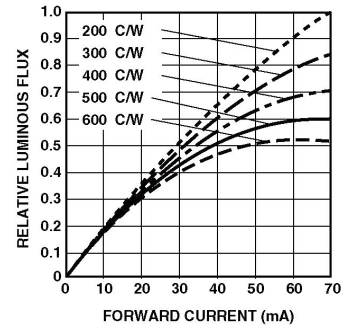

Figure 3. HPWA/HPWT-xx02 Relative Luminous Flux vs. Forward Current.

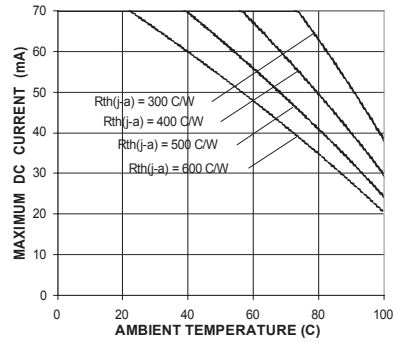

Figure 4a. HPWA-xx02 Maximum DC Forward Current vs. Ambient Temperature.

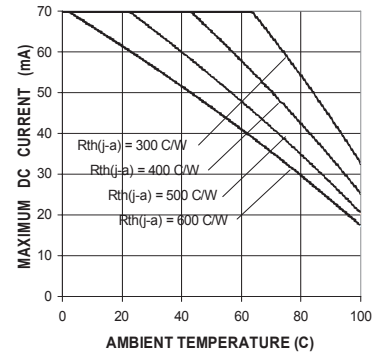

Figure 4b. HPWT-xx02 Maximum DC Forward Current vs. Ambient Temperature.

Note:

1.24mm² of Cu pad per emitter at cathode lead is recommended for lowest thermal resistance.

1. All Figures Typical unless indicated as Maximum.

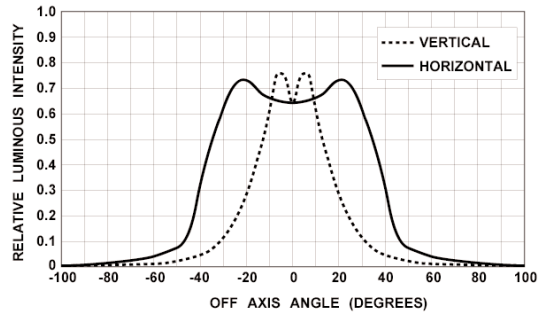

Figure 5a. HPWT-Rx02 Relative Luminous Intensity vs. Off Axis Angle.

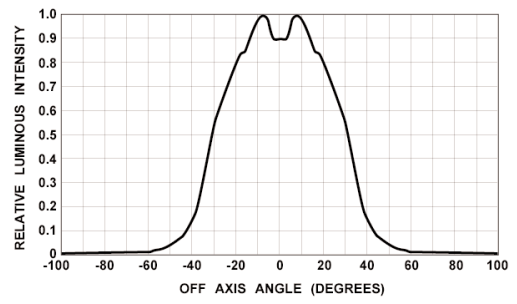

Figure 5d. HPWA(T)-Dx02 Relative Luminous Intensity vs. Off Axis Angle.

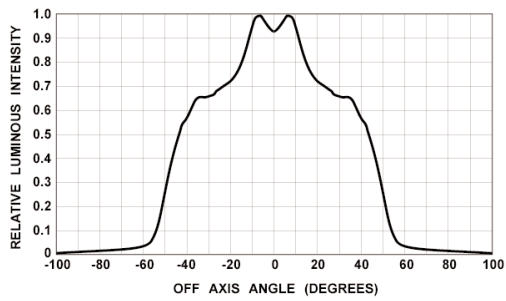

Figure 5b. HPWA-Mx02 Relative Luminous Intensity vs. Off Axis Angle.

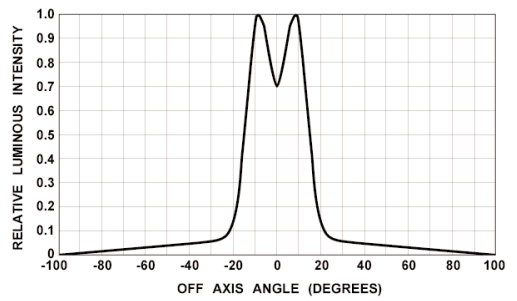

Figure 5e. HPWT-Bx02 Relative Luminous Intensity vs. Off Axis Angle.

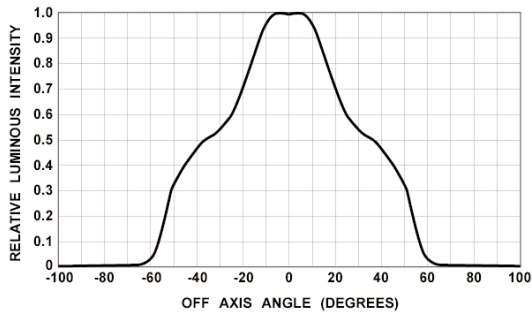
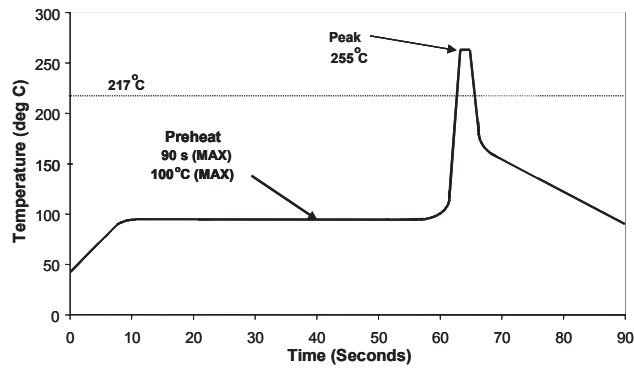

Figure 5c. HPWT-Mx02 Relative Luminous Intensity vs. Off Axis Angle.

1. All Figures Typical unless indicated as Maximum.

Recommended Soldering Conditions for Pb-Free SuperFlux



Solder Conditions

Preheat Temperature	85 +/- 15°C
Preheat Time	70s +/- 20s
Peak Profile Temperature	250 +/- 5°C
Solder Time Above 217°C	2.5 +/- 0.5s

Note:

1. All top preheat stages are to be turned off so that the lamp body is not directly exposed to the heat source.
2. Profile taken on the LED lead at the bottom of the PCB.
3. Single wave soldering is recommended.



Company Information

LUXEON®, SuperFlux and SnapLED are developed, manufactured and marketed by Philips Lumileds Lighting Company. Philips Lumileds is a world-class supplier of Light Emitting Diodes (LEDs) producing billions of LEDs annually. Philips Lumileds is a fully integrated supplier, producing core LED material in all three base colors (Red, Green, Blue) and White. Philips Lumileds has R&D centers in San Jose, California and in The Netherlands and production capabilities in San Jose and Penang, Malaysia. Founded in 1999, Philips Lumileds is the high-flux LED technology leader and is dedicated to bridging the gap between solid-state LED technology and the lighting world. Philips Lumileds technology, LEDs and systems are enabling new applications and markets in the lighting world.

Philips Lumileds may make process or materials changes affecting the performance or other characteristics of our products. These products supplied after such changes will continue to meet published specifications, but may not be identical to products supplied as samples or under prior orders.



WWW.LUXEON.COM
WWW.LUMILEDSFUTURE.COM

FOR TECHNICAL ASSISTANCE OR THE LOCATION OF YOUR NEAREST SALES OFFICE CONTACT ANY OF THE FOLLOWING:

NORTH AMERICA:
+1 888 589 3662 OR
ASKLUXEON@FUTUREELECTRONICS.COM

EUROPE:
OO 800 443 88 873 OR
LUXEON.EUROPE@FUTUREELECTRONICS.COM

ASIA:
800 5864 5337 OR
LUMILEDS.ASIA@FUTUREELECTRONICS.COM