



Micropower, 500mA Low Noise CMOS LDO Regulator

Features

- 500mA output current capability
 - **500mA peak in SOT-23 package**
 - **500mA continuous in MSOP package**
- 500mV maximum dropout voltage at full load
- Excellent line and load regulation
- Stable with any output capacitor
- Ultra low noise with optional bypass capacitor
- Fast power-up with bypass capacitor
- “Zero” current in Shutdown mode
- Thermal Overload Protection
- Foldback Current Limiting Protection
- Reverse current protection

Applications

- Notebook, and palmtop computers
- Cell phones and battery powered devices
- Consumer and personal electronics
- PC Card Vcc and Vpp regulation and switching

Table 1: CM3019 Regulator Family

Product	Output Voltage
CM3019-00	Adjustable
CM3019-12	1.2V
CM3019-15	1.5V
CM3019-18	1.8V
CM3019-25	2.5V
CM3019-28	2.8V
CM3019-30	3.0V
CM3019-33	3.3V

For other output voltages, please contact the factory

Product Description

The CM3019 is a CMOS linear voltage regulator with low quiescent current, very low drop out voltage and better than 1% initial output voltage accuracy.

The quiescent current is typically 150µA at light loads and only 165µA at 500mA. This is 5% more efficient than equivalent Bi-CMOS devices that can waste up to 25mA at 500mA.

Load regulation is maintained for peak currents up to 500mA. This is useful for supplying inrush currents during power-up and transient conditions. Continuous output current is limited by package type and board layout.

A dedicated control input (EN, Active High) has been included for power-up sequencing flexibility. When this input is taken low, the regulator is disabled. In this state, the supply current will drop to near zero.

The device also features reverse current protection. This protects the device by blocking the pass transistors parasitic diode when the output voltage is forced higher than the input.

For low noise performance and increased power supply ripple rejection a noise bypass capacitor can be connected to the BYP pin. Connecting this capacitor will not significantly delay the speed of power-up.

The CM3019 is fully protected, offering both overload current limiting and high temperature thermal shutdown.

To reduce board cost and layout size the CM3019 was designed to be stable with or without any output capacitor. This includes tiny, low ESR ceramic capacitors.

Housed in a low profile MSOP8 package, or a SOT23-5/SOT23-6, the device is ideal for space critical applications.

Typical Application Circuit

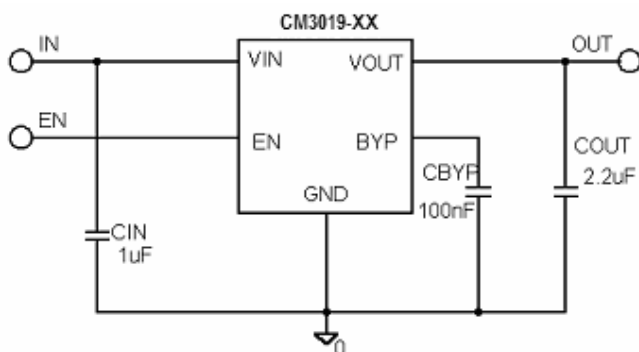

Block Diagram

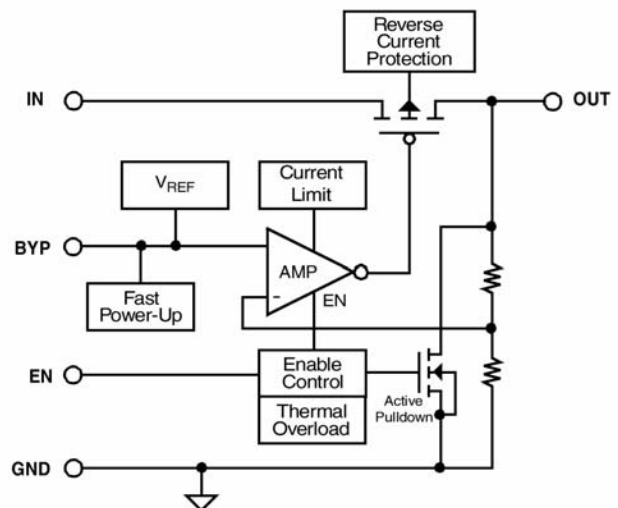



PACKAGE / PINOUT DIAGRAM

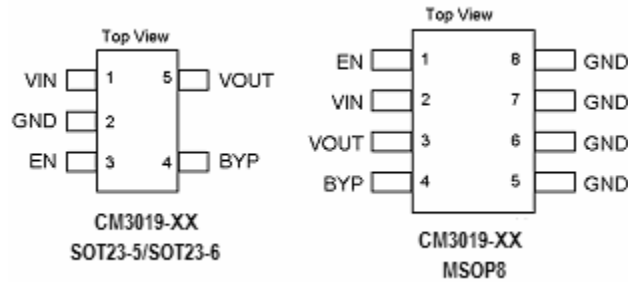

PIN DESCRIPTIONS

SOT-23-5 Pin	MSOP 8 Pin	Symbol	Description
1	1	IN	IN is the input power source for the regulator. If this input is within a few inches of the main supply filter, a capacitor may not be necessary. Otherwise an input filter capacitor of about 1-10uF will ensure adequate filtering.
2	5-8	GND	Ground is the negative reference for all voltages
3	1	EN	When this input is taken low (< 0.4V), the regulator is disabled. In this state, the supply current will drop to near zero.
4	4	BYP	Reference Bypass Pin. Connect to an external capacitor for noise reduction. A 10nF-100nF size ceramic capacitor is recommended.
5	3	OUT	Out is the regulator output voltage used to power the load. No output capacitor is required for stability. Output capacitance can be added to improve transient response, noise performance and power supply ripple rejection for frequencies over ~100kHz.

Note1: Tantalum, electrolytic or low cost ceramic capacitors may be used.

STANDARD PART ORDERING INFORMATION

Package		Ordering Information	
Pins	Style	Tape & Reel	Part Marking
6	SOT-23	CM3019-00ST	CB00
5	SOT-23	CM3019-12ST	CB12
5	SOT-23	CM3019-15ST	CB15
5	SOT-23	CM3019-18ST	CB18
5	SOT-23	CM3019-25ST	CB25
5	SOT-23	CM3019-28ST	CB28
5	SOT-23	CM3019-30ST	CB30
5	SOT-23	CM3019-33ST	CB33
8	MSOP	CM3019-00MA	CM30/1900
8	MSOP	CM3019-12MA	CM30/1912
8	MSOP	CM3019-15MA	CM30/1915
8	MSOP	CM3019-18MA	CM30/1918
8	MSOP	CM3019-25MA	CM30/1925
8	MSOP	CM3019-28MA	CM30/1928
8	MSOP	CM3019-30MA	CM30/1930
8	MSOP	CM3019-33MA	CM30/1933



Specifications

Absolute Maximum Ratings		
Parameter	Rating	Unit
V _{IN} Voltage	+ 6.0, Gnd - 0.6	V
EN, V _{OUT} Voltages	V _{CC} + 0.6, Gnd - 0.6	V
Temperature: Storage	- 40 to +150	°C
Operating Ambient	-40 to +85	
Operating Junction	0 to +150	
Power Dissipation	Internally limited	W

Operating Conditions		
Parameter	Range	Unit
V _{IN}	2.2 to 6.0	V
Temperature (Ambient)	-40 to +85	°C
Load Current	0 to 500	mA
C _{OUT} ^{note2}	0-50	µF

Electrical Operating Characteristics						
V _{OUT} +1V < V _{IN} & 2.5V < V _{IN} < 6V, I _{OUT} =1mA, C _{IN} =2.2µF, T _J =25°C, C _{OUT} =2.2µF, V _{SD} =1.5V, unless specified otherwise.						
bold values indicate -40°C < T _J < 125°C						
Symbol	Parameter	Conditions	MIN	TYP	MAX	UNIT
V _{OUT}	Output Voltage Accuracy	T _A = 25 °C 0 °C < T _J < 125 °C -40 °C < T _J < 125 °C	-1 -2 -3		1 2 3	% % %
VR LINE	Line Regulation ^{Note4}	V _{OUT} +1V < V _{IN} & 2.5V < V _{IN} < 6V		0.1	0.2 0.4	%/V
VR LOAD	Load Regulation	I _{OUT} =1mA to 500mA ^{Note3} V _{IN} =V _{OUT} +1V		0.1	0.25 0.5	%
R _{DROP}	Dropout Resistance	I _{OUT} =1mA to 500mA V _{IN} =V _{OUT} (nominal)-100mV		0.7	1 1.2	Ω
I _{GND}	Ground Current	EN tied to V _{CC} , I _{LOAD} = 1mA		150	200	µA
		EN tied to V _{CC} , I _{LOAD} = 500mA		165	200	µA
		EN tied to GND, (Disable Mode)		0.01	1	µA
V _{EN}	Enable Voltage	Regulator enabled	1.5			V
V _{DIS}	Disable Voltage	Regulator shutdown			0.4 0.18	V
I _{EN}	Enable Input Current			0.01		µA
PSRR	Power Supply Ripple Rejection	f=1kHz		75		dB
e _N	Output Noise Voltage	C _{BYP} =0.1µF, BW=10Hz to 100kHz		30		µVrms
t _{on}	V _{OUT} Turn-On-Time	C _{BYP} =0µF		80		µs
		C _{BYP} =0.1µF		100		µs
I _{LIM}	Overload Current Limit			800		mA
I _{SC}	Short Circuit Current	V _{OUT} < 0.5V		550		mA
T _{JSD}	Thermal Shutdown Junction Temperature			165		°C
T _{HYST}	Thermal Hysteresis			20		°C

Note 2: Tantalum, electrolytic or low cost ceramic capacitors may be used.

Note 3: Regulation voltages and dropout resistance is measured at constant junction temperature using low duty cycle pulse testing.

Note 4: Line regulation is displayed as the average regulation across the full operating range measured in %/V.

Thermal Performance		
Package	θ _{JA} Minimum Footprint	θ _{JA} 1" square 2oz copper
SOT23-5/SOT23-6	220 °C/W	170 °C/W
MSOP8 Fused	160 °C/W	70 °C/W



Typical DC Characteristics (nominal conditions unless specified otherwise)

Nominal Conditions: $C_{IN} = 1\mu F$, $C_{OUT} = 2.2\mu F$, No C_{BYP} , $V_{IN} = 4.0V$, Load = 5mA (all plots measured with 3.0V V_{OUT})

Load Regulation

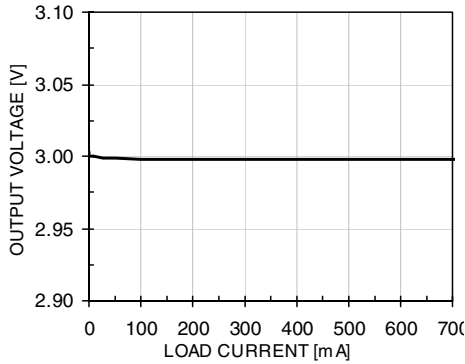

Dropout Voltage ($V_{OUT}=2.9V$)

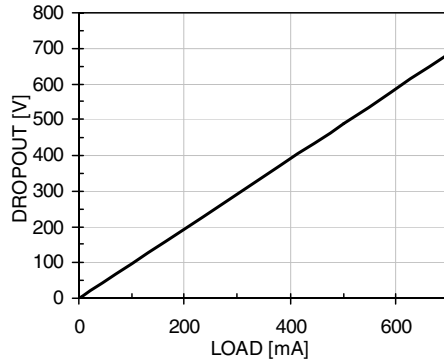

Foldback Current Limiting

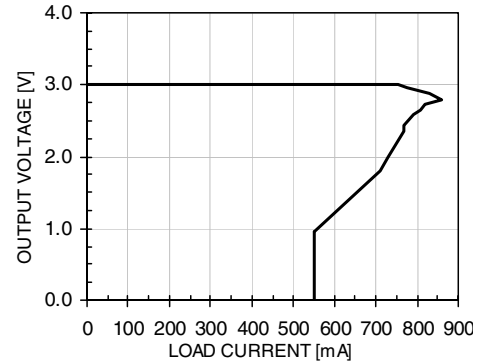

Line Regulation

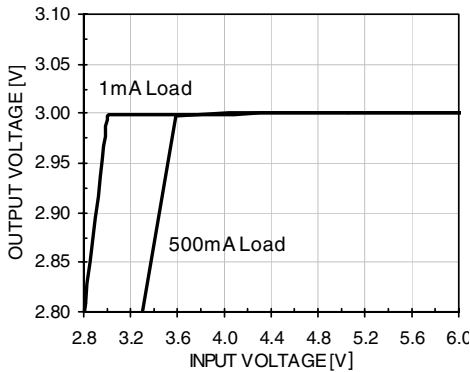

Line Regulation

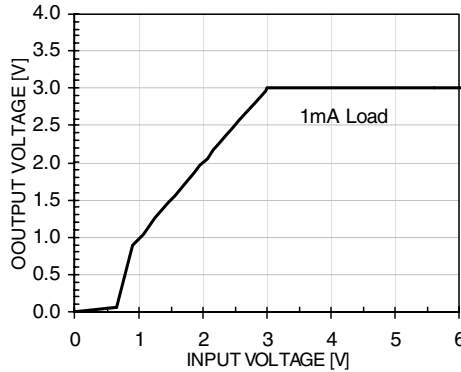

Enable Voltage Threshold

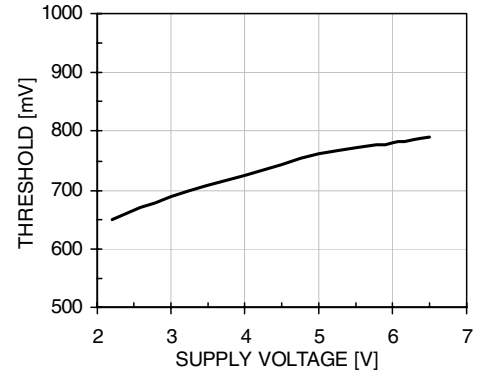

Supply Current vs. Voltage ($EN = V_{IN}$)

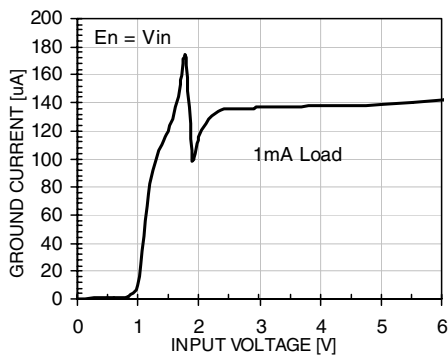

Ground Current vs. Output Load

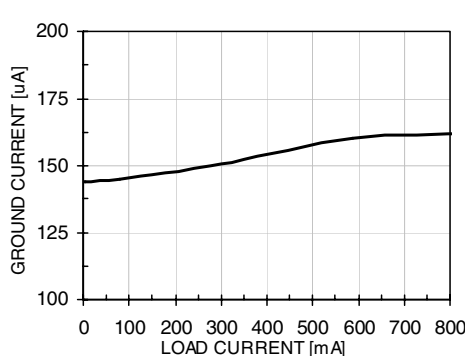

Output Supply Current vs. Voltage

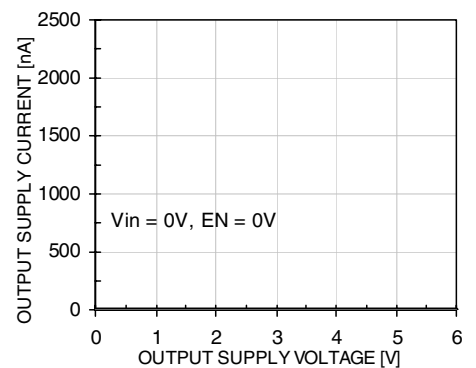



Input Supply Current vs. Voltage

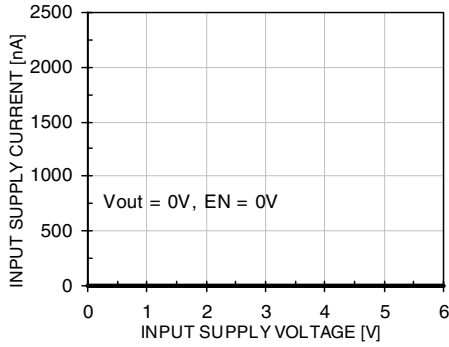

Input Supply Current vs. Voltage

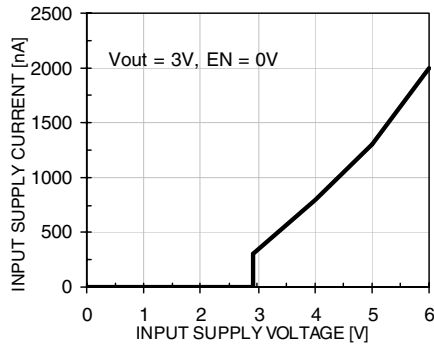

Output Supply Current vs. Voltage

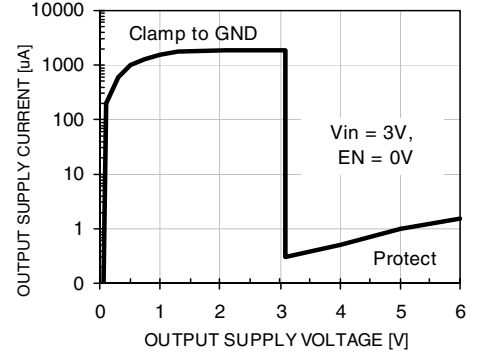

Transient Characteristics (nominal conditions unless specified otherwise)

Nominal Conditions: C_{IN} = 1µF, C_{OUT} = 2.2µF, No C_{BYP}, V_{IN} = 4.0V, Load = 5mA (all plots measured with 3.0V V_{OUT})

10% to 90% Load Step (t_r=1µs)

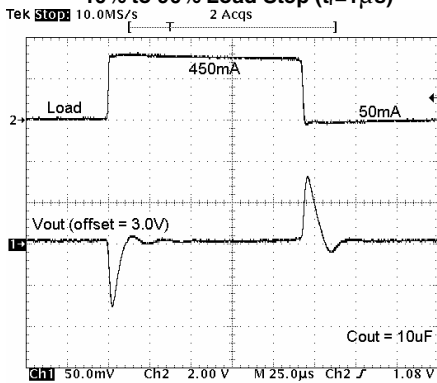

10% to 90% Load Step (t_r=1µs)

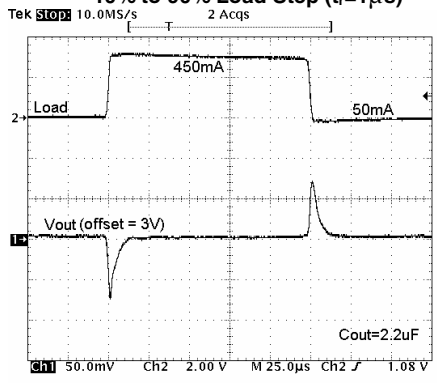

10% to 90% Load Step (t_r=1µs)

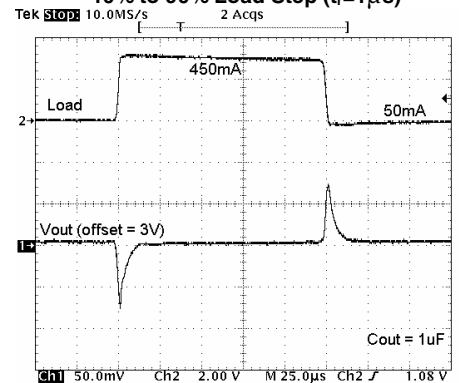

3.5V - 4.5V Line Step (t_r=1µs)

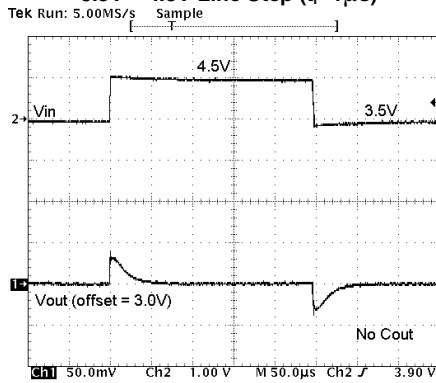

3.5V - 4.5V Line Step (t_r=1µs)

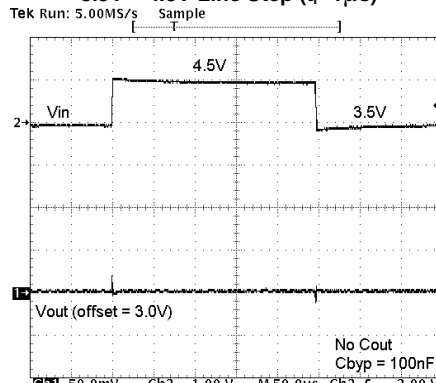

3.5V - 4.5V Line Step (t_r=1µs)

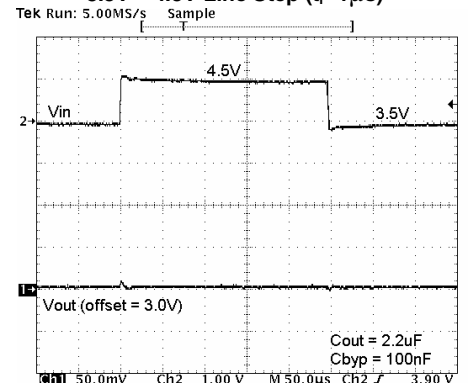

Enable Response

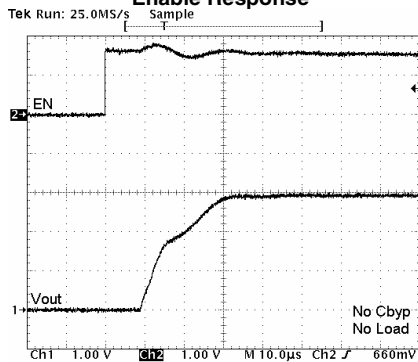

Enable Response

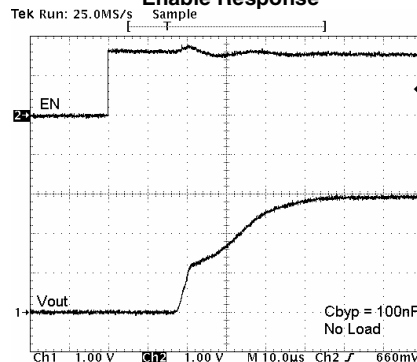

Disable Response

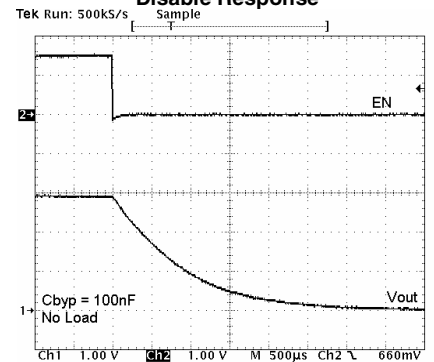

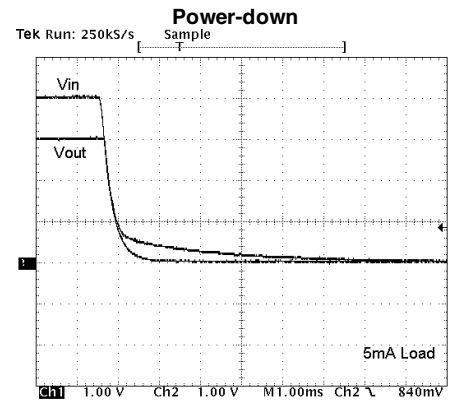
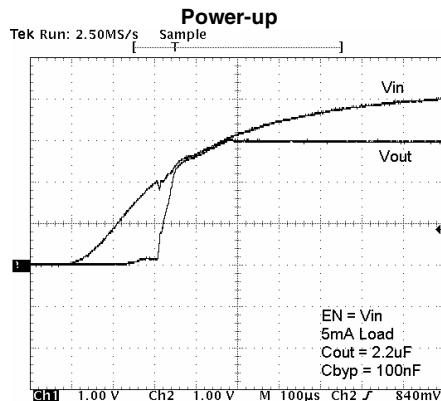
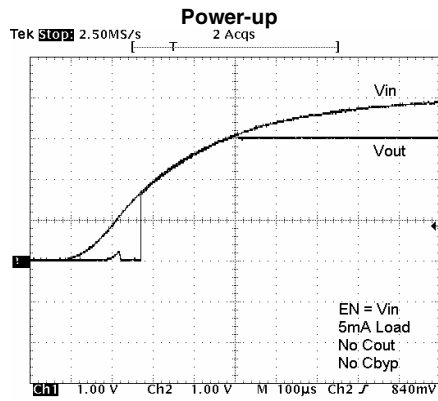

Power Supply Ripple Rejection and Noise (nominal conditions unless specified otherwise)
 Nominal Conditions: $C_{IN} = 1\mu F$, $V_{IN} = 4.0V$, PSRR measured with 50mV pk-pk sin wave on V_{IN} .
 (all plots measured with 3.0V V_{OUT})

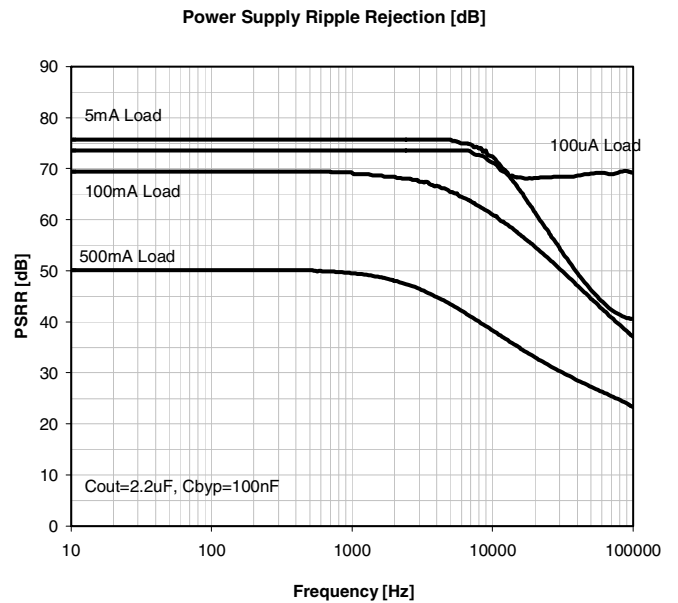
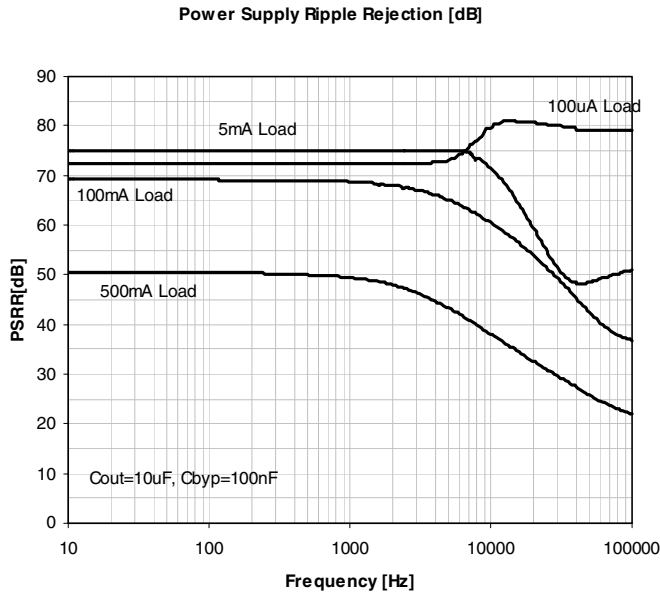



Power Supply Ripple Rejection [dB]

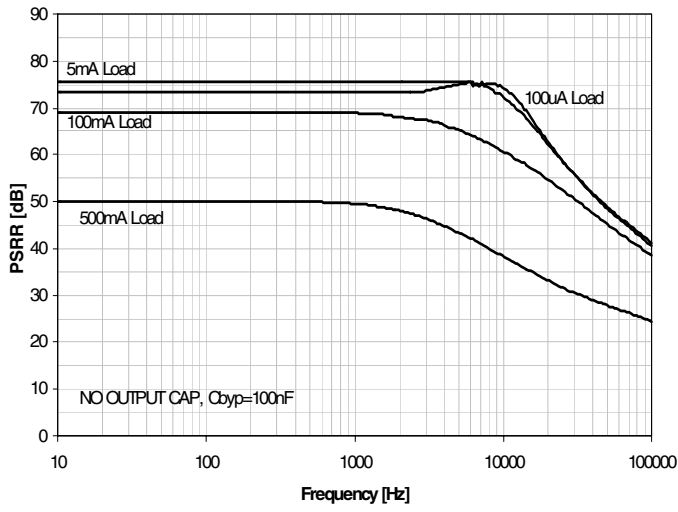

Output noise spectral density (100uA Load)

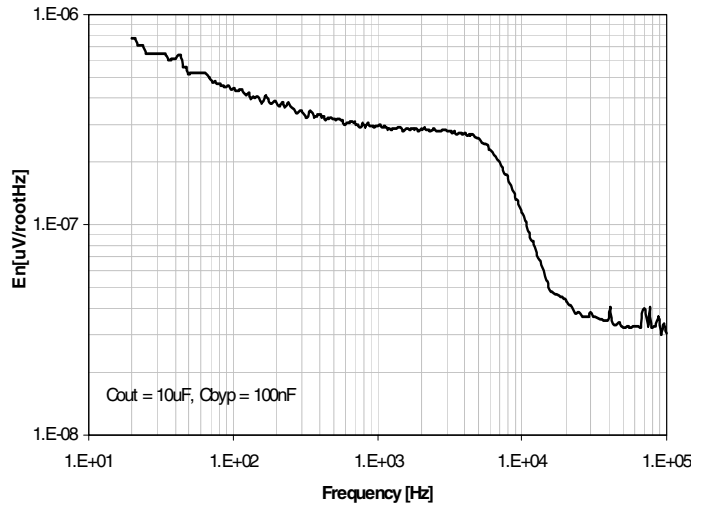



Typical Thermal Characteristics (nominal conditions unless specified otherwise)

Nominal Conditions: $C_{IN} = 1\mu F$, $C_{OUT} = 2.2\mu F$, No CBYP, $V_{IN} = 4.0V$, Load = 5mA (all plots measured with 3.0V V_{out})

V_{OUT} vs. Temperature

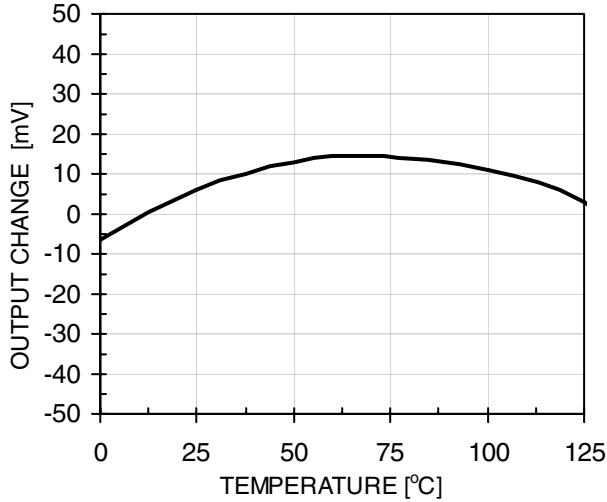

V_{OUT} vs. Temperature

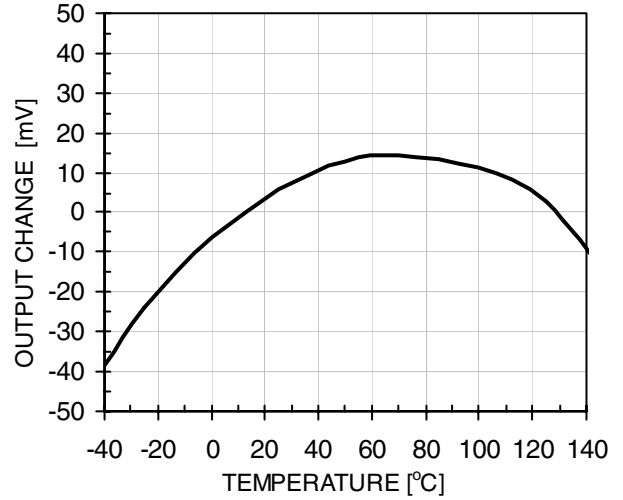

I_{GND} vs. Temperature

