



APPLICATIONS

TV FINAL PICTURE IF AMPLIFIER APPLICATIONS.

ABSOLUTE MAXIMUM RATINGS (Ta=25°C)

- Tstg—Storage Temperature..... -55~150°C
Tj—Junction Temperature.....150°C
Pc—Collector Dissipation.....300mW
Vcbo—Collector-Base Voltage.....50V
Vceo—Collector-Emitter Voltage.....45V
Veb0—Emitter-Base Voltage.....4V
Ic—Collector Current.....50mA
Ie—Emitter Current.....-50mA

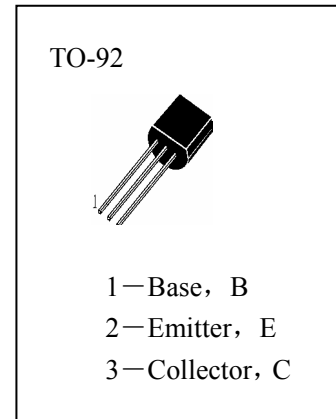

ELECTRICAL CHARACTERISTICS (Ta=25°C)

Table with 7 columns: Symbol, Characteristics, Min, Typ, Max, Unit, Test Conditions. Rows include BVcbo, BVceo, BVebo, Icbo, Iebo, HFE, VCE(sat), VBE(sat), Cob, ft, Gpe.

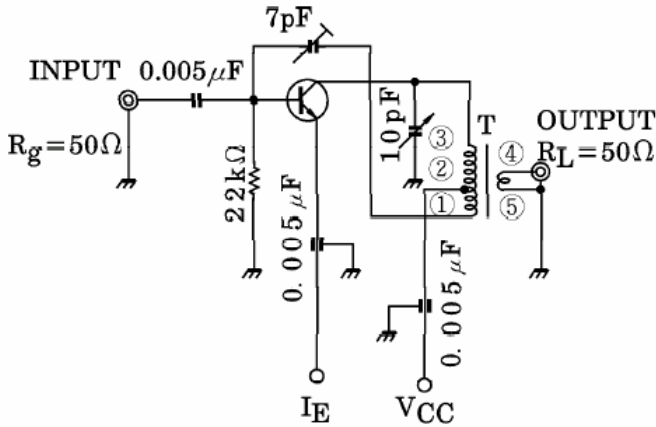

COIL DATA
 0.20mm ϕ Cu WIRE
 L=1.2 μ H WITH M-5 CORE
 T : ①-② 3.0T
 ②-③ 8.0T
 ④-⑤ 1.0T

Fig. 45MHz G_{pe} TEST CIRCUIT

