

HF7520

SUBMINIATURE POWER RELAY



File No.: E133481



File No.: R50050775

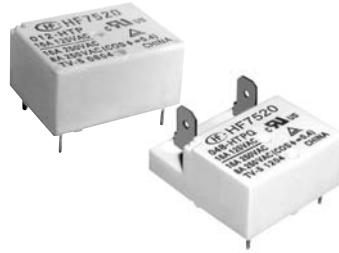

Features

- Low height, flat construction
- High rating: 16A
- High sensitive: 200mW
- PCB & QC layouts available
- Wash tight and flux proofed types (with vent-hole cover) available
- Environmental friendly product (RoHS compliant)
- Outline Dimensions: (22.0 x 16.0 x 10.9) mm

CONTACT DATA

Arrangement	1C	1A
Contact resistance	100mΩ (at 1A 6VDC)	
Contact material	See ordering info.	
Contact rating (Res. load)	NO: 10A 125/250VAC NC: 6A 125/250VAC	Standard type: TV-5 10A 30VDC 10A 125/250VAC
		High capacity type(P): TV-5 10A 30VDC 16A 125/250VAC 8A 250VAC(cosφ=0.4)
Max.switching voltage	250VAC	250VAC/30VDC
Max.switching current	NO:10A NC: 6A	16A
Max.switching power	NO: 2500VA NC: 1500VA	4000VA/300W
Mechanical endurance	1x10 ⁷ OPS	
Electrical endurance	1x10 ⁵ OPS	

COIL

Coil power	1A: 200mW; 1C: 400mW
------------	----------------------

SPECIFICATION

Insulation resistance	1000MΩ (at 500VDC)	
Dielectric strength	Between coil & contacts	2500VAC 1 min
	Between open contacts	1000VAC 1 min
Operate time (at nomi.volt)	10ms max.	
Release time (at nomi.volt)	5ms max.	
Shock resistance	Functional	100m/s ² (10g)
	Destructive	1000m/s ² (100g)
Vibration resistance	10Hz to 55Hz 1.5mm DA	
Humidity	35% to 85% RH	
Ambient temperature	-40°C to 85°C	
Termination	1C: PCB 1A: PCB & QC	
Unit weight	Approx.8g	
Construction	Wash tight, Flux proofed	

- Notes: 1) The data shown above are initial values.
2) Please find coil temperature curve in the characteristic curves below.

SAFETY APPROVAL RATINGS

UL&CUR	1 Form A	TV-5 16A 125VAC 10A 250VAC 10A 30VDC
	1 Form C	NO: 10A 250VAC NC: 6A 250VAC
TÜV	1 Form A	16A 250VAC 10A 30VDC 8A 250VAC (COSφ=0.4)

- Notes: Only some typical ratings are listed above. If more details are required, please contact us.



HONGFA RELAY

ISO9001、ISO/TS16949、ISO14001、OHSAS18001 CERTIFIED

2007 Rev. 2.00

COIL DATA

at 23°C

1 Form C Type

Nominal Voltage VDC	Pick-up Voltage VDC	Drop-out Voltage VDC	Max. Allowable Voltage VDC	Coil Resistance Ω
5	4.0	0.5	6.5	62.5 x (1±10%)
6	4.8	0.6	7.8	90 x (1±10%)
9	7.2	0.9	11.7	202.5 x (1±10%)
12	9.6	1.2	15.6	360 x (1±10%)
18	14.4	1.8	23.4	810 x (1±10%)
24	19.2	2.4	31.2	1440 x (1±10%)
48	38.4	4.8	62.4	5760 x (1±10%)

1 Form A Type

Nominal Voltage VDC	Pick-up Voltage VDC	Drop-out Voltage VDC	Max. Allowable Voltage VDC	Coil Resistance Ω
5	4.0	0.5	7.5	125 x (1±10%)
6	4.8	0.6	9	180 x (1±10%)
9	7.2	0.9	13.5	405 x (1±10%)
12	9.6	1.2	18	720 x (1±10%)
18	14.4	1.8	27	1620 x (1±10%)
24	19.2	2.4	36	2880 x (1±10%)
48	38.4	4.8	72	11520 x (1±10%)

ORDERING INFORMATION

Type	HF7520 / 012 -H S T P Q (XXX)
Coil voltage	5, 6, 9, 12, 18, 24, 48VDC
Contact arrangement	H: 1 Form A Z: 1 Form C
Construction ¹⁾	S: Wash tight Nil: Flux proofed
Contact material	T: AgSnO ₂ Nil: AgCdO (only for 1A) AgNi (only for 1C)
Contact capacity	P: High Capacity type (only for 1A) Nil: Standard type
Terminal type	Q: QC (only for 1A & high capacity type) Nil: PCB
Customer special code ²⁾ (Only for special requirements)	e.g. (551) stands for RoHS compliant (Cadmium containing contacts) (555) stands for RoHS compliant (Cadmium-free contacts)

Notes: 1) Under the ambience with dangerous gas like H₂S, SO₂ or NO₂, wash tight type is recommended; please test the relay in real applications. If the ambience allows, flux proofed is preferentially recommended.

2) HF7520 is an environmental friendly product. Please mark a special code (555) or (551) when ordering. (551) stands RoHS compliant with Cadmium contact; (555) stands for RoHS compliant with Cadmium-free contact.

3) If choose wash tight type for body cleanout concern, please cut the vent hole after the process.

OUTLINE DIMENSIONS , WIRING DIAGRAM AND PC BOARD LAYOUT

Unit: mm

1 Form A (PCB)

Outline Dimensions

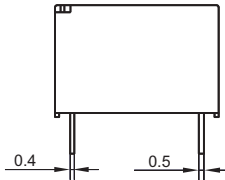
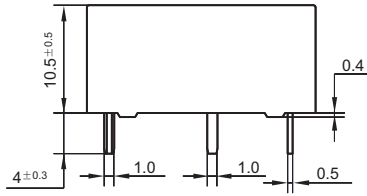

Wiring Diagram (Bottom View)

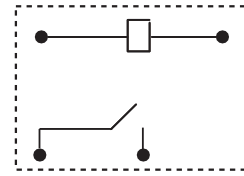

PCB Layout (Bottom view)

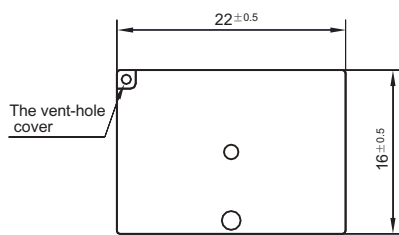

(Top view)

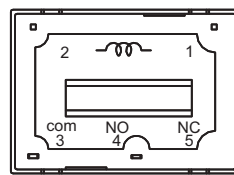

(Bottom View)

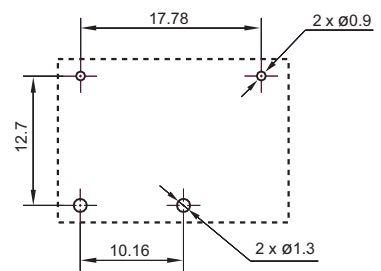

1 Form A (QC)

Outline Dimensions

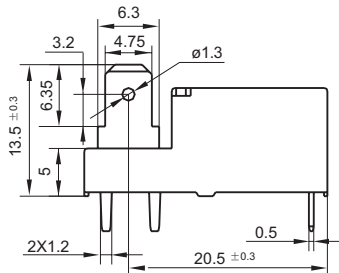
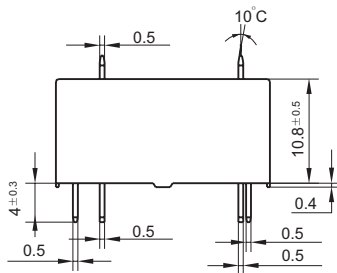

Wiring Diagram

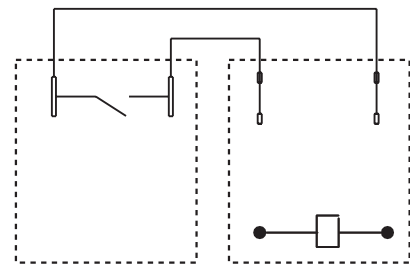

(Top View)

(Bottom View)

PCB Layout (Bottom view)

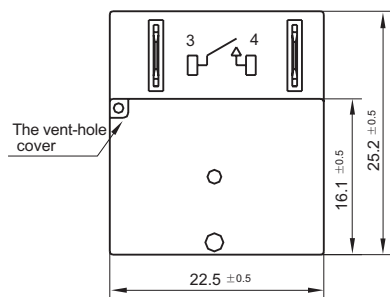

(Top view)

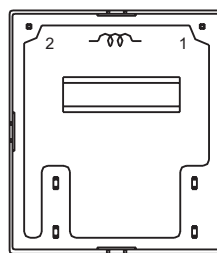

(Bottom View)

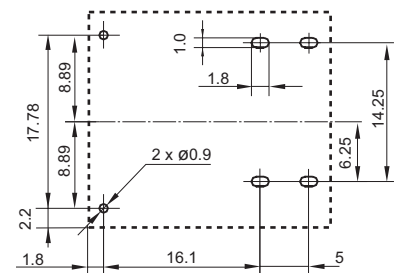

OUTLINE DIMENSIONS , WIRING DIAGRAM AND PC BOARD LAYOUT

Unit: mm

1 Form C (PCB)

Outline Dimensions

Wiring Diagram
(Bottom View)

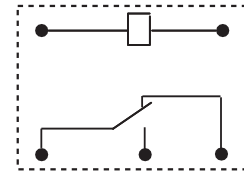
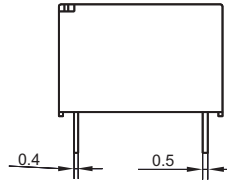
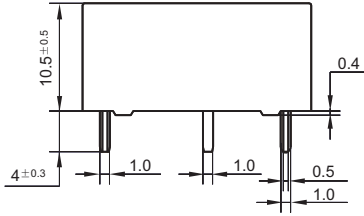

PCB Layout
(Bottom view)

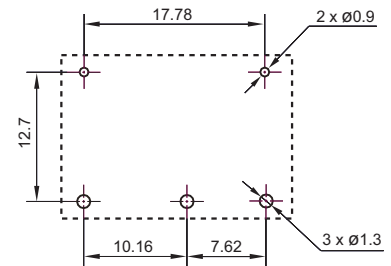
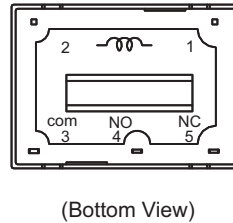
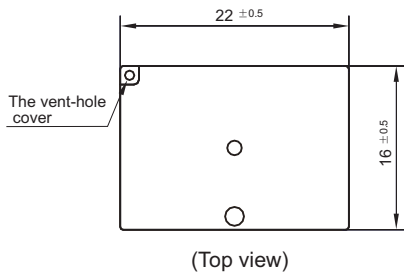

Remark: 1) In case of no tolerance shown in outline dimension: outline dimension $\leq 1\text{mm}$, tolerance should be $\pm 0.2\text{mm}$; outline dimension $> 1\text{mm}$ and $\leq 5\text{mm}$, tolerance should be $\pm 0.3\text{mm}$; outline dimension $> 5\text{mm}$, tolerance should be $\pm 0.4\text{mm}$.
2) The tolerance without indicating for PCB layout is always $\pm 0.1\text{mm}$.

CHARACTERISTIC CURVES

MAXIMUM SWITCHING POWER

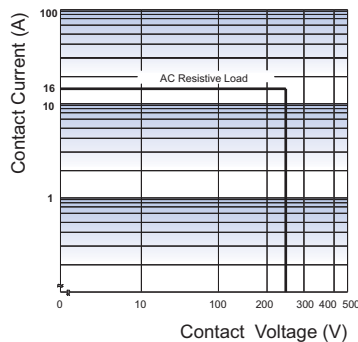

ENDURANCE CURVE

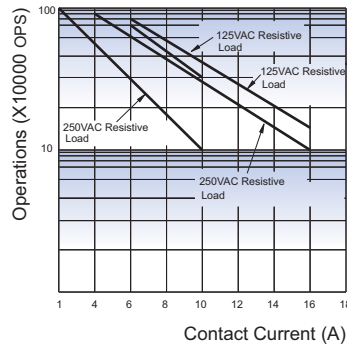

COIL TEMPERATURE RISE

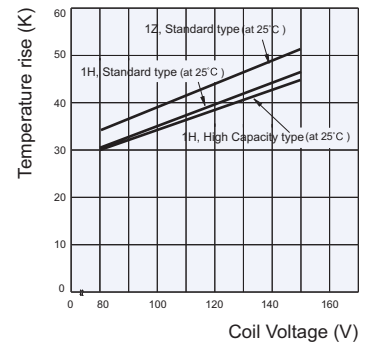

Disclaimer

This datasheet is for the customers' reference. All the specifications are subject to change without notice. We could not evaluate all the performance and all the parameters for every possible application. Thus the user should be in a right position to choose the suitable product for their own application. If there is any query, please contact Hongfa for the technical service. However, it is the user's responsibility to determine which product should be used only.

© Xiamen Hongfa Electroacoustic Co., Ltd. All rights of Hongfa are reserved.