

RADIAL LEADED INDUCTORS

■ OPERATING TEMP

-25 ~ +85°C (Including self-generated heat)

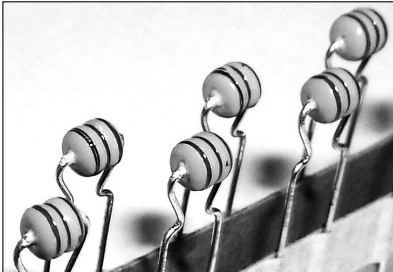

■ FEATURES

- The RD Series inductors are available in 3 form factors range from 35 to 45.
- For small current applications

■ APPLICATION

Consumer electronics such as VCR, TV and Monitor other electronic equipment.

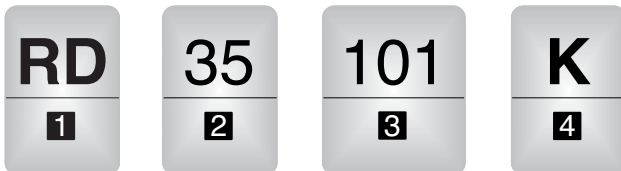

■ MARKING

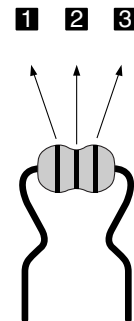

■ ORDERING CODE

1 TYPE	
RD	Radial Leaded Inductor

2 TYPE DIMENSION	
35	6.0 × 4.0
40	8.0 × 5.0
45	9.5 × 6.0

3 MARKING INDUCTANCE	
R22	0.22μH
1R5	1.5μH
120	12μH

4 INDUCTANCE TOLERANCE	
J	± 5%
K	± 10%

Color	Inductance[μH]		
	1st Digit	2nd Digit	Multiplier
	1	2	3
Black	0		× 1
Brown	1		× 10
Red	2		× 100
Orange	3		× 1000
Yellow	4		-
Green	5		-
Blue	6		-
Purple	7		-
Grey	8		-
White	9		-
Gold	-		× 0.1
Silver	-		× 0.01

RADIAL LEADED INDUCTORS

■ TAPING DIMENSIONS

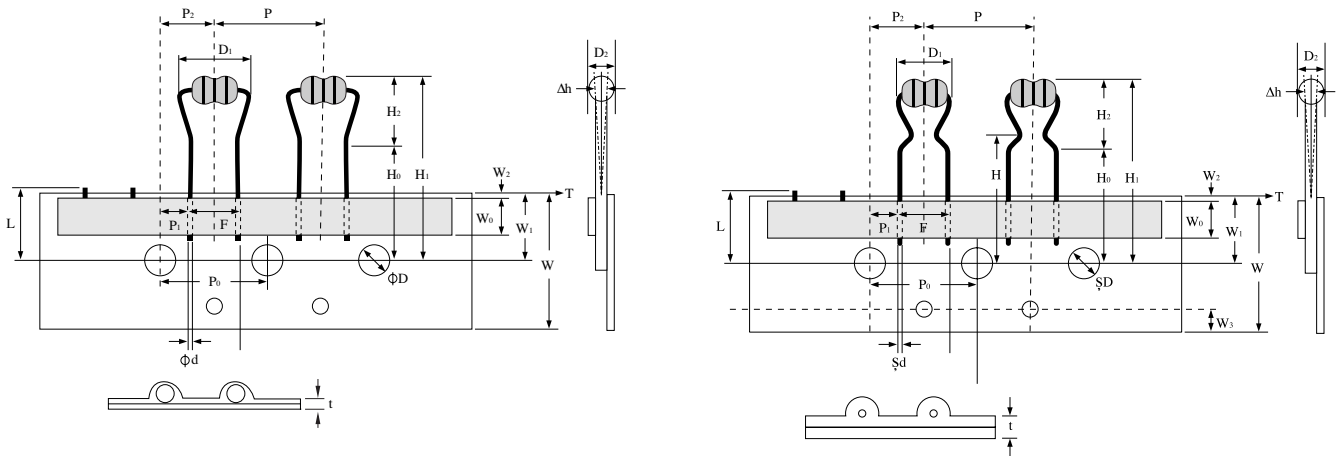

Note 1. No more than 3 consecutive pieces can be omitted.

Unit: mm

Symbol	Dimensions			
	RD35H	RD35	RD40	RD45
D1	7.5max.	6.0max.	8.0max.	9.5max.
D2	4.0max.	4.0max.	5.0max.	6.0max.
H1	26max.	26max.	27.5max.	27.5max.
H2	5max.	9max.	10.5max.	10.5max.
H0	$6.5 \leq H_0 - W_1$			
P	12.7 ± 1.0			
P0	12.7 ± 0.3			
P1	3.85 ± 0.5			
P2	6.35 ± 1.3			
F	$5.0^{+0.8}_{-0.3}$		$5.0^{+0.6}_{-0.2}$	
Δh	0.0 ± 2.0			
W	$18^{+1.0}_{-0.5}$			
W0	6.0 ± 0.1			
W1	$9^{+0.75}_{-0.5}$		$9^{+1.0}_{-0.5}$	
W2	$T \geq W_2$			
ØD	4.0 ± 0.3			
Ød	0.50 ± 0.05		0.60 ± 0.05	
L	11.0max.			
t	0.5 ± 2.0			

P0: Accumulated error for 20 pitches is ± 1 mm

W2: Bonding tape must not protrude from the base tape.

■ PACKAGING

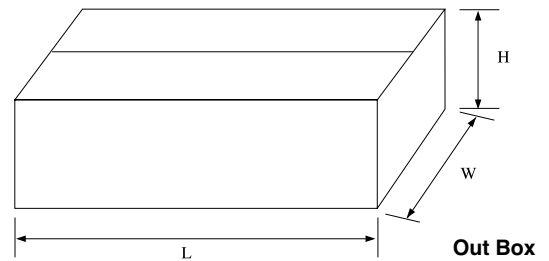
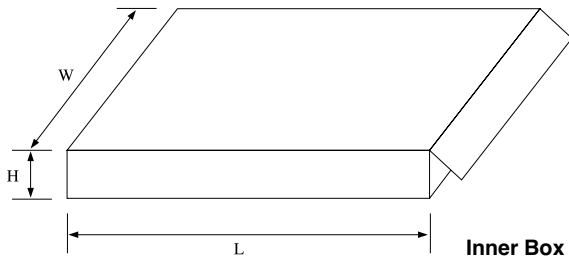

Type	Inner Box		Out Box			Item
	Size(mm) (W×H×L)	Quantity	Size(mm) (W×H×L)	Quantity	Wtight	
RD Series	187×40×325	2,000	340×255×580	36,000	12Kg	RD35
		1,000		18,000	10Kg	RD40
		1,500		27,000	18Kg	RD45
		2,000		36,000	12Kg	RD35H

■ AVAILABLE INDUCTANCE RANGE

Type		0.22	1 μ H	10 μ H	100 μ H	1,000 μ H	10,000 μ H	20,000 μ H
RD35	I _{max} .(mA)	1,000	790	460	150	55		
	Inductance(μ H)					1,000 μ H		
	R _{dc} (m Ω)	0.09	0.17	0.45	3.3	28		
RD40	I _{max} .(mA)	816	707	353	174	48		
	Inductance(μ H)					2,200 μ H		
	R _{dc} (m Ω)	0.15	0.2	0.8	3.3	42		
RD45	I _{max} .(mA)			780	260	85	21	
	Inductance(μ H)							15,000 μ H
	R _{dc} (m Ω)			0.19	0.85	8.9	160	
RD35H	I _{max} .(mA)	1,000	790	460	150	56		
	Inductance(μ H)					1,000 μ H		
	R _{dc} (m Ω)	0.09	0.17	0.45	3.3	31.5		

RADIAL LEADED
INDUCTORS

ITEM PART NUMBERS

● RD35

Ordering Code	Inductance [μ H]	Inductance Tolerance	Q (min.)	Measuring Frequency [MHz]	Self-Resonant Frequency [MHz] (min.)	DC Resistance [Ω] (max.)	Rated Current [mA] (max.)
RD35R22K	0.22	$\pm 10\%$ ($\pm 5\%$)	50	25.2	170	0.09	1000
RD35R27K	0.27				160	0.10	980
RD35R33K	0.33				140	0.11	960
RD35R39K	0.39				130	0.12	940
RD35R47K	0.47				120	0.13	910
RD35R56K	0.56				110	0.14	880
RD35R68K	0.68				100	0.15	850
RD35R82K	0.82				90	0.16	820
RD351R0K	1.0				82	0.17	790
RD351R2K	1.2				70	0.18	760
RD351R5K	1.5			65	0.20	730	
RD351R8K	1.8			57	0.22	700	
RD352R2K	2.2			47	0.24	670	
RD352R7K	2.7			40	0.26	640	
RD353R3K	3.3			35	0.28	610	
RD353R9K	3.9			33	0.30	580	
RD354R7K	4.7			31	0.33	560	
RD355R6K	5.6			27	0.36	540	
RD356R8K	6.8			24	0.39	520	
RD358R2K	8.2			22	0.42	490	
RD35100K	10			21	0.45	460	
RD35120K	12			18	1.2	350	
RD35150K	15			16	1.3	330	
RD35180K	18			14	1.4	300	
RD35220K	22			13	1.5	270	
RD35270K	27			12	1.6	250	
RD35330K	33			11	1.8	235	
RD35390K	39			10	2.0	220	
RD35470K	47			9.5	2.2	200	
RD35560K	56			9.0	2.4	190	
RD35680K	68			8.5	2.8	170	
RD35820K	82			8.0	3.0	155	
RD35101K	100			7.5	3.3	150	
RD35121K	120			6.8	4.2	140	
RD35151K	150			6.2	5.0	130	
RD35181K	180			5.6	6.0	125	
RD35221K	220			5.0	7.5	120	
RD35271K	270			4.6	11	105	
RD35331K	330			4.2	13	95	
RD35391K	390			3.8	15	90	
RD35471K	470	3.4	17	80			
RD35561K	560	3.0	19	75			
RD35681K	680	2.6	22	68			
RD35821K	820	2.2	25	60			
RD35102K	1000	2.0	28	55			

● RD35H

Ordering Code	Inductance [μH]	Inductance Tolerance	Q (min.)	Measuring Frequency [MHz]	Self-Resonant Frequency [MHz] (min.)	DC Resistance [Ω] (max.)	Rated Current [mA] (max.)
RD35T-R22K-H	0.22	± 10% (± 5%)	50	25.2	170.0	0.09	1000
RD35T-R27K-H	0.27				160.0	0.10	980
RD35T-R33K-H	0.33				140.0	0.11	960
RD35T-R39K-H	0.39				130.0	0.12	940
RD35T-R47K-H	0.47				120.0	0.13	910
RD35T-R56K-H	0.56				110.0	0.14	880
RD35T-R68K-H	0.68				100.0	0.15	850
RD35T-R82K-H	0.82				90.0	0.16	820
RD35T-1R0J-H	1.0			7.96	82.0	0.17	790
RD35T-1R2J-H	1.2				70.0	0.18	760
RD35T-1R5J-H	1.5				65.0	0.20	730
RD35T-1R8J-H	1.8				57.0	0.22	700
RD35T-2R2J-H	2.2				47.0	0.24	670
RD35T-2R7J-H	2.7				40.0	0.26	640
RD35T-3R3J-H	3.3				35.0	0.28	610
RD35T-3R9J-H	3.9				33.0	0.30	580
RD35T-4R7J-H	4.7				31.0	0.33	560
RD35T-5R6J-H	5.6				27.0	0.36	540
RD35T-6R8J-H	6.8				24.0	0.39	520
RD35T-8R2J-H	8.2				22.0	0.42	490
RD35T-100J-H	10			2.52	21.0	0.45	460
RD35T-120J-H	12				18.0	1.2	350
RD35T-150J-H	15				16.0	1.3	330
RD35T-180J-H	18				14.0	1.4	300
RD35T-220J-H	22				13.0	1.5	270
RD35T-270J-H	27				12.0	1.6	250
RD35T-330J-H	33				11.0	1.8	235
RD35T-390J-H	39				10.0	2.0	220
RD35T-470J-H	47				9.5	2.2	200
RD35T-560J-H	56				9.0	2.4	190
RD35T-680J-H	68				8.5	2.8	170
RD35T-820J-H	82				8.0	3.0	155
RD35T-101K-H	100			0.796	7.5	3.3	150
RD35T-121K-H	120				6.8	4.2	140
RD35T-151K-H	150				6.2	5.0	130
RD35T-181K-H	180				5.6	6.0	125
RD35T-221K-H	220				5.0	7.5	120
RD35T-271K-H	270				4.6	11.0	105
RD35T-331K-H	330				4.2	13.0	95
RD35T-391K-H	390				3.8	15.0	90
RD35T-471K-H	470	3.4	17.0		80		
RD35T-561K-H	560	2.4	21.0		69		
RD35T-681K-H	680	2.2	23.5		65		
RD35T-821K-H	820	2.0	26.5		61		
RD35T-102K-H	1000	25	0.252	1.8	31.5	56	

RADIAL LEADED
INDUCTORS

ITEM PART NUMBERS

● RD40

Ordering Code	Inductance [μ H]	Inductance Tolerance	Q (min.)	Measuring Frequency [MHz]	Self-Resonant Frequency [MHz] (min.)	DC Resistance [Ω] (max.)	Rated Current [mA] (max.)
RD40R22K	0.22	$\pm 10\%$ ($\pm 5\%$)	50	25.2	150	0.15	816
RD40R27K	0.27				150	0.15	816
RD40R33K	0.33				150	0.15	816
RD40R39K	0.39				130	0.15	816
RD40R47K	0.47				130	0.15	816
RD40R56K	0.56				130	0.20	707
RD40R68K	0.68				120	0.20	707
RD40R82K	0.82				120	0.20	707
RD401R0K	1.0			7.96	100	0.20	707
RD401R2K	1.2				85	0.20	707
RD401R5K	1.5				70	0.22	674
RD401R8K	1.8				60	0.22	674
RD402R2K	2.2				55	0.25	632
RD402R7K	2.7				50	0.27	608
RD403R3K	3.3				45	0.30	577
RD403R9K	3.9				40	0.32	559
RD404R7K	4.7			35	0.35	534	
RD405R6K	5.6			33	0.37	519	
RD406R8K	6.8			27	0.40	500	
RD408R2K	8.2			25	0.45	471	
RD40100K	10			2.52	20	0.80	353
RD40120K	12				18	0.90	333
RD40150K	15				17	1.0	316
RD40180K	18				15	1.2	288
RD40220K	22				13	1.4	267
RD40270K	27				11	1.7	242
RD40330K	33				10.5	2.0	223
RD40390K	39				10.0	2.4	204
RD40470K	47		9.5	2.7	192		
RD40560K	56		9.0	2.9	185		
RD40680K	68		8.5	3.1	179		
RD40820K	82		7.5	3.3	174		
RD40101K	100		0.796	6.8	3.3	174	
RD40121K	120			6.2	3.5	169	
RD40151K	150			5.7	3.7	164	
RD40181K	180			5.3	4.0	158	
RD40221K	220			4.0	5.2	138	
RD40271K	270			3.6	5.8	131	
RD40331K	330			3.3	6.5	124	
RD40391K	390			3.0	7.5	115	
RD40471K	470		2.8	8.0	111		
RD40561K	560		2.4	12.5	89		
RD40681K	680	2.2	14.0	84			
RD40821K	820	2.0	15.5	80			
RD40102K	1000	40	1.8	18.5	73		
RD40122K	1200	30	1.7	29.0	58		
RD40152K	1500		1.5	34.0	54		
RD40182K	1800		1.4	37.0	51		
RD40222K	2200		1.2	32.0	48		

● RD45

Ordering Code	Inductance [μ H]	Inductance Tolerance	Q (min.)	Measuring Frequency [MHz]	Self-Resonant Frequency [MHz] (min.)	DC Resistance [Ω] (max.)	Rated Current [mA] (max.)
RD45 100K	10	$\pm 10\%$ ($\pm 5\%$)	20	2.52	17.0	0.19	780
RD45 120K	12				14.0	0.22	730
RD45 150K	15				12.0	0.24	650
RD45 180K	18				10.5	0.26	610
RD45 220K	22				10.0	0.29	540
RD45 270K	27				9.5	0.32	480
RD45 330K	33				8.5	0.34	440
RD45 390K	39				8.0	0.42	410
RD45 470K	47				7.0	0.47	375
RD45 560K	56				6.8	0.52	340
RD45 680K	68		15	6.5	0.58	320	
RD45 820K	82			6.3	0.64	285	
RD45 101K	100		25	6.0	0.85	260	
RD45 121K	120			5.4	1.00	240	
RD45 151K	150			4.8	1.20	215	
RD45 181K	180		30	4.0	1.50	195	
RD45 221K	220			3.9	1.65	180	
RD45 271K	270		35	3.6	2.15	160	
RD45 331K	330			3.3	2.90	145	
RD45 391K	390			3.0	3.25	135	
RD45 471K	470		40	2.8	4.05	125	
RD45 561K	560			2.4	4.45	115	
RD45 681K	680		45	2.2	5.85	105	
RD45 821K	820			2.0	6.60	90	
RD45 102K	1000			1.8	8.90	85	
RD45 122K	1200		40	1.7	10.5	75	
RD45 152K	1500			1.5	11.9	70	
RD45 182K	1800			1.3	16.5	60	
RD45 222K	2200			1.2	19.0	58	
RD45 272K	2700			0.252	0.8	32.0	52
RD45 332K	3300				0.7	34.0	48
RD45 392K	3900				0.7	38.0	45
RD45 472K	4700				0.6	56.0	40
RD45 562K	5600				0.5	63.0	37
RD45 682K	6800			0.4	70.0	34	
RD45 822K	8200	0.4	77.0	31			
RD45 103K	10000	25	0.3	95.0	28		
RD45 123K	12000		0.0796	0.2	110.0	25	
RD45 153K	15000			20	0.1	160.0	21

RADIAL LEADED
INDUCTORS

ELECTRICAL CHARACTERISTICS

● DC Bias Characteristics (Measured by HP4284A + HP42841A)

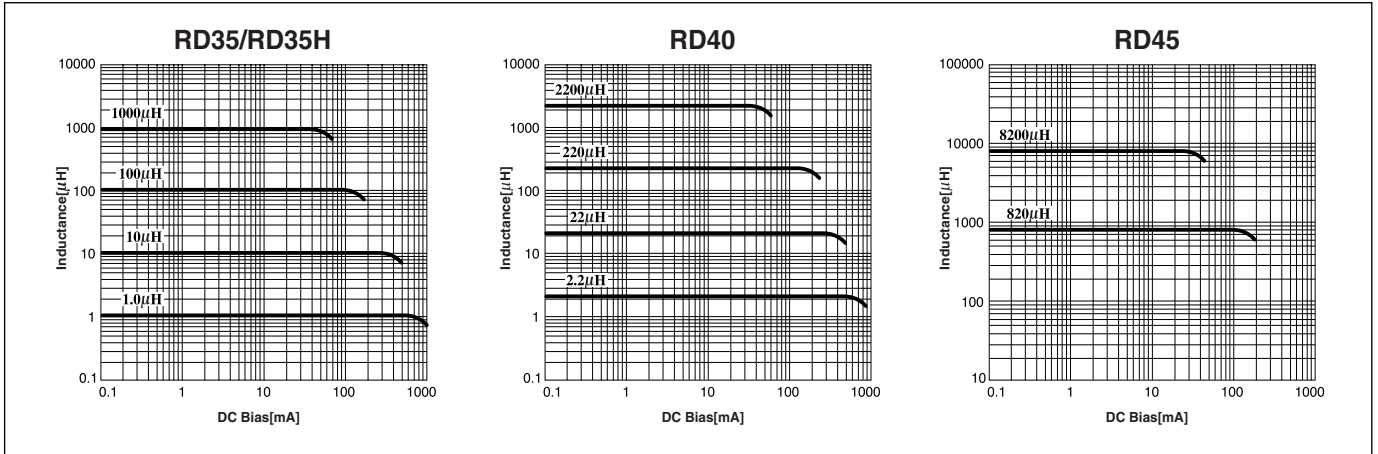

● Temperature Characteristics (Measured by HP4284A + HP42841A)

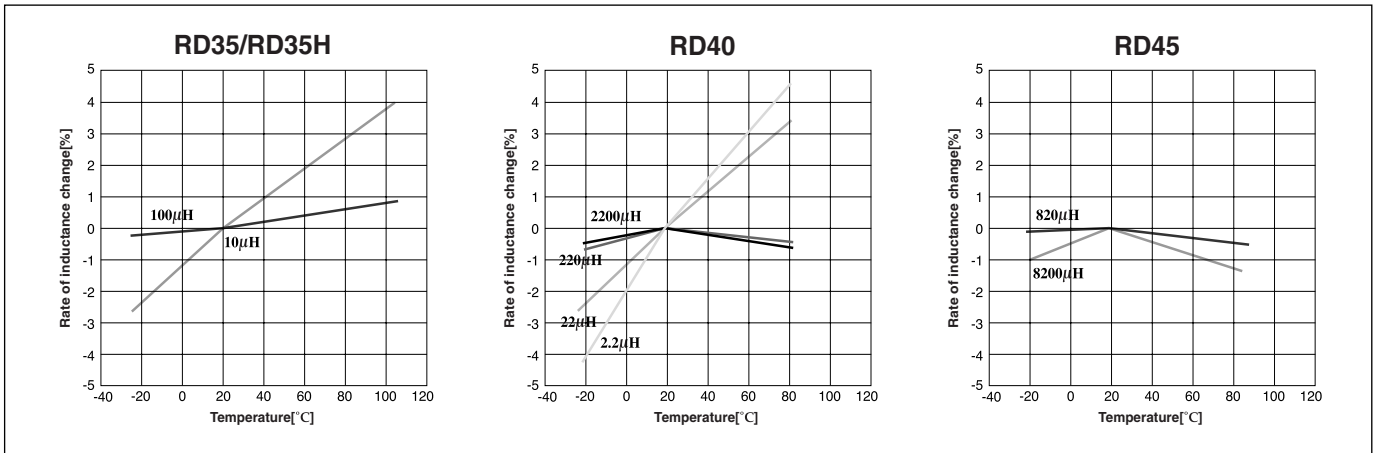

● Q-Characteristics (Measured by HP 4285A + HP 42851A)

