

FEATURES

- UL1950 Recognized
- Input-Output Isolation
- Compact, Single In-Line Package
- Single and Dual Output
- Wide-Range Input
- Input and Output Filters

SPECIFICATIONS

INPUT

Voltage See Model Selection Table

Max. Input Current

Input Voltage	Full Load Input Current
5V	1.1 to 0.6A
12V	0.55 to 0.27A
24V	0.26 to 0.14A
48V	0.15 to 0.07A

OUTPUT

Output Voltage See Model Selection Table

Set Point $\pm 5\%$

Regulation

Total $\pm 5\%$ (5% to 100% load change)

Noise & Ripple, (peak-to-peak)

5V Output 100 mV max.

+12V, $\pm 12V$ Output 120 mV

+15V, $\pm 15V$ Output 150 mV

Output Current See Model Selection Table

Short-Circuit Protection Special constant-current circuit provides indefinite protection against overload or short circuit

Insulation Resistance 100 M Ω at 500 VDC

Dielectric Strength 500 VDC for 1 minute

ENVIRONMENTAL

Operating Ambient

Temp. -10 to $+70^{\circ}\text{C}$ (See Derating Chart)

Storage Temp. -30 to $+80^{\circ}\text{C}$

MODEL SPECIFICATIONS

OUTPUT		MODEL AND INPUT RANGE				EFFIC.
VOLTS	AMPS	4.0-7.2VDC	8.0-16.5VDC	16-32VDC	28-60VDC	
5	0.6	HDF0505S	HDF1205S	HDF2405S	HDF4805S	77 - 80%
12	0.26	HDF0512S	HDF1212S	HDF2412S	HDF4812S	80 - 85%
15	0.21	HDF0515S	HDF1215S	HDF2415S	HDF4815S	80 - 85%
± 12	0.125	HDF0512D	HDF1212D	HDF2412D	HDF4812D	74 - 77%
± 15	0.1	HDF0515D	HDF1215D	HDF2415D	HDF4815D	74 - 77%

1500 VAC Isolation available on some models – consult the factory

DERATING CHART

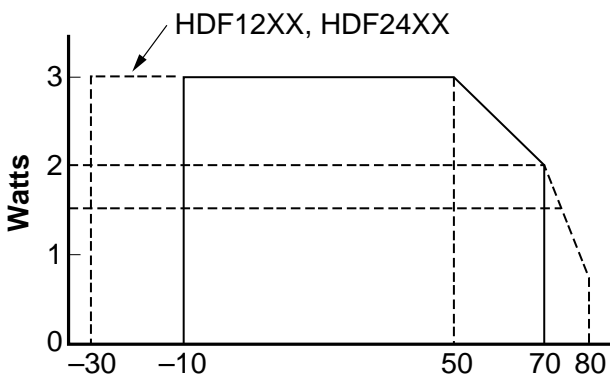

BLOCK DIAGRAM

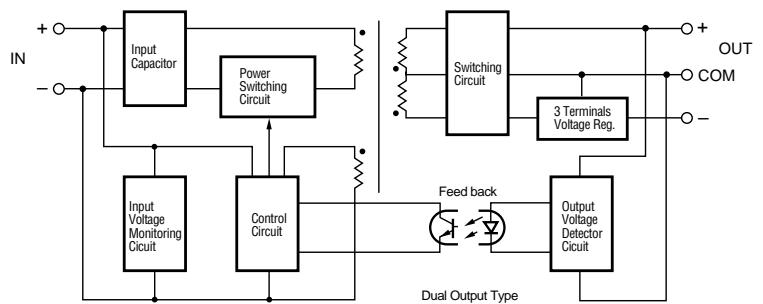

MECHANICAL SPECIFICATIONS

Size (W x D x H) 1.75 x 0.81 x 0.43" (44.5 x 20.5 x 10.5 mm)
 Weight 0.6 oz (16 g)

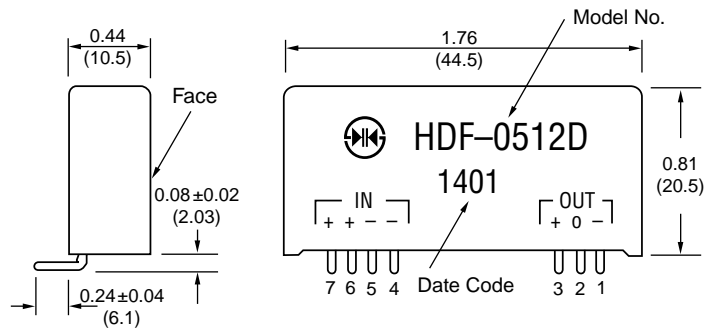
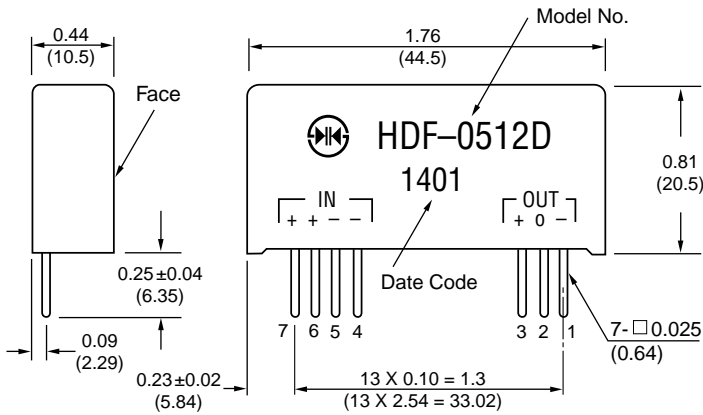

With optional formed leads available - use "-F suffix." Dimensions in inches; () Dimensions in mm.

PIN DESCRIPTION

PIN #	1	2	3	4, 5	6, 7
FUNCTION-D	OUT-	COM	OUT+	IN-	IN+
FUNCTION-S	NC	OUT-	OUT+	IN-	IN+

M d I N

APPLICATION EXAMPLES

1. Reverse Polarity Output

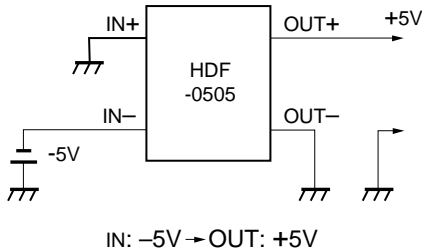
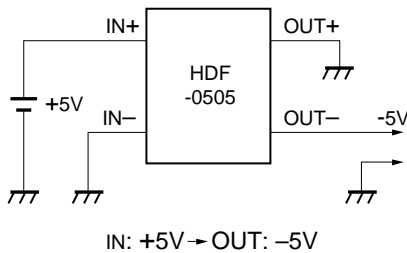

3. Series Connection of Dual Output modules

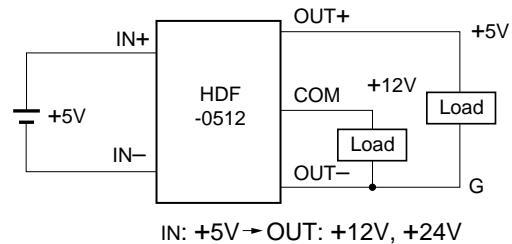
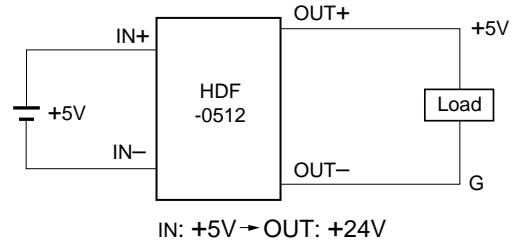

■ Because the current output from the OUT-terminal is the sum of the +24V and the +12V outputs, this value must not exceed the rated output current. In the HDF-0512D, this value is 125 mA.

2. Series Connection of Output with Input

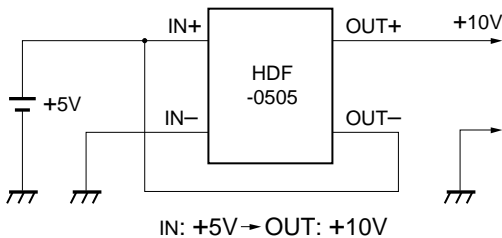

■ The output current capacity is the same as the output current capacity of the converter. (For example, an HDF-0505 connected as shown above has an output rating of 10 VDC at 600 mA.)

■ The combined output regulation is:
 (Output regulation of HDF-0505) + (Input Voltage Fluctuation)

4. Series Connection of Two or More Units

