

# EMC Components

## ZJSR Series

### 3-Terminal Filters for Signal Line and DC Power Line Lead(Round)

#### FEATURES

- The ZJSR series combine TDK's high performance ferrite bead and a chip capacitor. This board mounted EMC filter is used to prevent microcomputer operational errors and stop noise generation. Most suitable for use in countering radio noise generated by digital circuits.
- SIP shape with 2.4mm max. thickness, making possible high density mounting upon a PCB in a row at DIP pitch.
- When using taped product, possible to mount using automatic equipment.
- Excellent high frequency bypass performance due to short earth-side capacitor lead.

#### PRODUCT IDENTIFICATION

ZJSR5101 - 101 TA

(1) (2) (3)

(1)Series name

(2)Capacitance 101:100pF

(3)Packaging style TA: Taping

(not needed for specification of bulk products)

#### SHAPES AND DIMENSIONS

##### TAPING SPECIFICATIONS

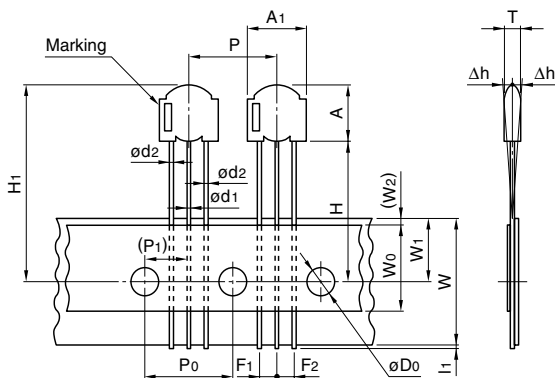

##### BULK SPECIFICATIONS

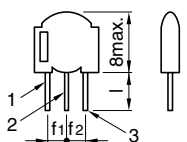

##### CIRCUIT DIAGRAM

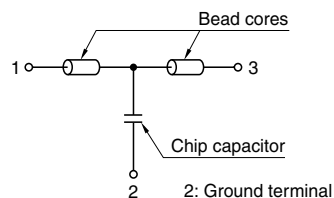

##### TYPICAL MOUNTING EXAMPLE

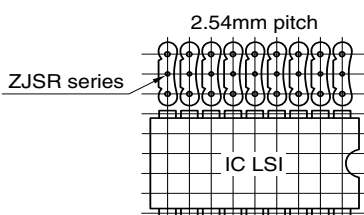

#### APPLICATIONS

Home electronic equipment, (TVs, VCRs, CD players, DAT players, electric musical instruments, PCs, etc.), office automation equipment (computers, terminals, stand-alone word processors, fax machines, etc.), factory automation equipment (robots, numerical control devices, process controllers, etc.), automotive electronics (automotive engine control units, etc.)

#### BASIC CHARACTERISTICS

Series	ZJSR
Rated voltage E <sub>dc</sub>	50V
Rated current	5A
Withstand voltage E <sub>dc</sub> [Between terminal, No.1, 3 to 2]	125V
Insulation resistance [DC. 50V for 1 min]	10000MΩ min.
DC resistance[Terminal No.1 to 3]	0.05Ω max.
Operating temperature range	-25 to +85°C

- This product should not be used under conditions that exceed those listed above.
- Please note that this product is an EMC filter, so should not be used as a surge absorber, etc.

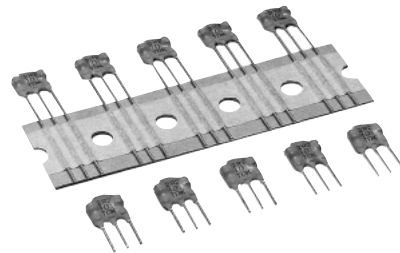

Dimensions in mm

Series	ZJSR
Component width	A <sub>1</sub> 8.5max.
Component height	A 8max.
Component thickness	T 2.4max.
Lead wire diameter (round)	ød <sub>1</sub> 0.5±0.05 ød <sub>2</sub> 0.6±0.05
Component pitch	P 12.7±1
Feed hole pitch	P <sub>0</sub> 12.7±0.3
Feed hole position error	P <sub>1</sub> 6.35±0.4
Lead pitch	F <sub>1</sub> , F <sub>2</sub> 2.5±0.4, -0.1
Component alignment	Δh 0±2
Tape width	W 18+1, -0.5
Cover tape width	W <sub>0</sub> 12±0.3
Feed hole position error	W <sub>1</sub> 9±0.5
Cover tape position	(W <sub>2</sub> ) (4max.)
Component bottom position	H 20±1
Maximum component height	H <sub>1</sub> 28max.
Feed hole diameter	øD <sub>0</sub> 4±0.2
Lead wire protrusion	I <sub>1</sub> 0.5max.
Lead wire length	l 5±1.5
Lead pitch	f <sub>1</sub> , f <sub>2</sub> 2.5±0.5

- The tolerance of lead pitch is the dimensions when a lead is released from tape. Not available for bulk packaging.

# EMC Components

## ZJSR Series

### 3-Terminal Filters for Signal Line and DC Power Line Lead(Round)

#### ELECTRICAL CHARACTERISTICS

Part No.	Capacitance (pF)	Tolerance (%)	Maximum attenuation (MHz)	Frequency range (MHz)[normal mode]*		Marking
				15dB min. attenuation	25dB min. attenuation	
ZJSR5101-330	33	±20	700	400 to 800	650 to 800	330
ZJSR5101-470	47	±20	600	350 to 800	550 to 700	470
ZJSR5101-680	68	±20	500	250 to 800	450 to 600	680
ZJSR5101-101	100	±20	400	200 to 800	350 to 500	101
ZJSR5101-221	220	±20	280	100 to 800	200 to 350	221
ZJSR5101-331	330	±20	220	70 to 800	150 to 300	331
ZJSR5101-102	1000	±20	140	30 to 800	70 to 200	102
ZJSR5101-222	2200	±20	80	20 to 800	45 to 200	222
ZJSR5101-332	3300	±20	70	15 to 800	35 to 200	332
ZJSR5101-472	4700	±20	60	10 to 800	25 to 200	472
ZJSR5101-682	6800	±20	50	8 to 800	20 to 200	682
ZJSR5101-103	10000	+80, -20	35	6 to 800	15 to 200	103
ZJSR5101-223	22000	+80, -20	27	4 to 800	9 to 200	223
ZJSR5101-333	33000	+80, -20	20	3 to 800	7 to 200	333

\* Operating temperature range: +5 to +35°C

#### TYPICAL ELECTRICAL CHARACTERISTICS

##### ATTENUATION vs. FREQUENCY CHARACTERISTICS

Glass epoxy coated double side mounting PCB(t=1.6mm)

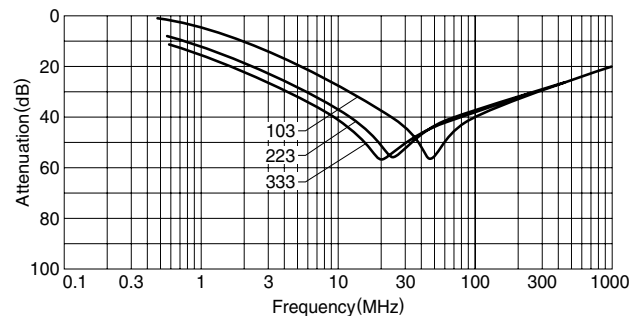
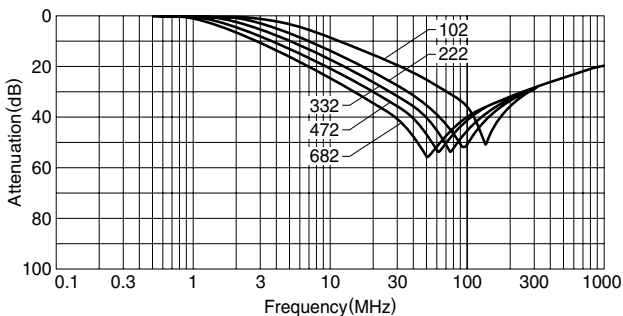
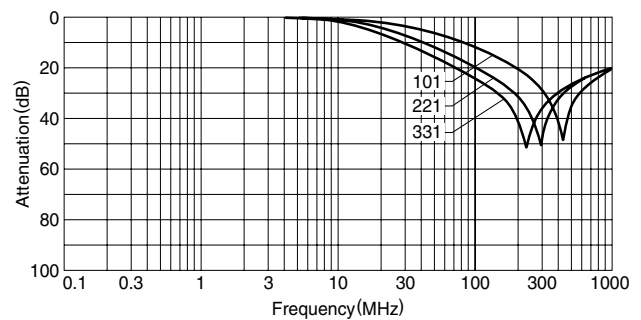
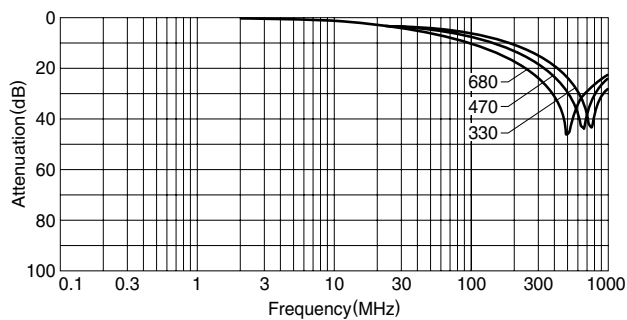

#### CIRCUIT DIAGRAM

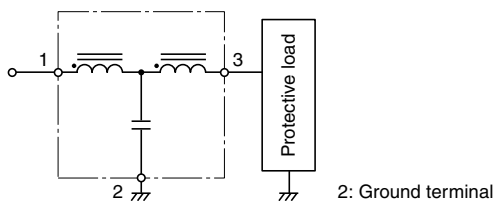

#### PACKAGING STYLE AND QUANTITIES

Packaging style	Quantity
Taping	2000 pieces/reel

#### PACKAGING STYLE (Ammo-pack)

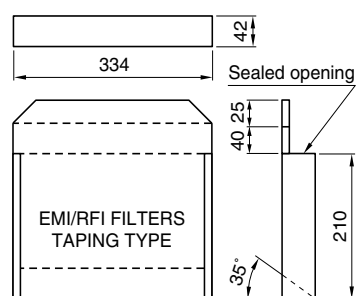

Dimensions in mm

#### INDICATES INTERIOR CONTENTS OF BOX

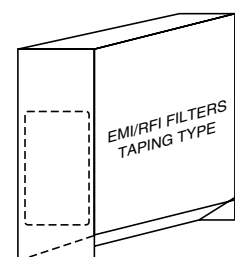

# EMC Components

## ZJSR Series

### 3-Terminal Filters for Signal Line and DC Power Line Lead(Round)

#### TECHNICAL NOTES

##### INSERTION ATTENUATION MEASUREMENT METHOD

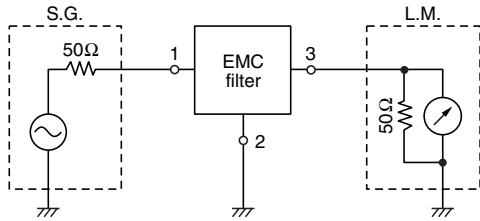

$$\text{Attenuation} = \log_{10} \frac{E_2}{E_1} \text{ (dB)}$$

E2: Set EMC filter in the circuit  
E1: Leave EMC filter in the circuit

##### MOUNTING SUBSTRATE FOR MEASUREMENT

Mount on the glass fabric-backed epoxy resin double-sided through-hole substrate (t=1.6mm)

##### MEASUREMENT TEMPERATURE

+5 to +35°C

##### TYPICAL APPLICATIONS

An example of radiated noise suppressing circuit by connecting a PC and a printer.

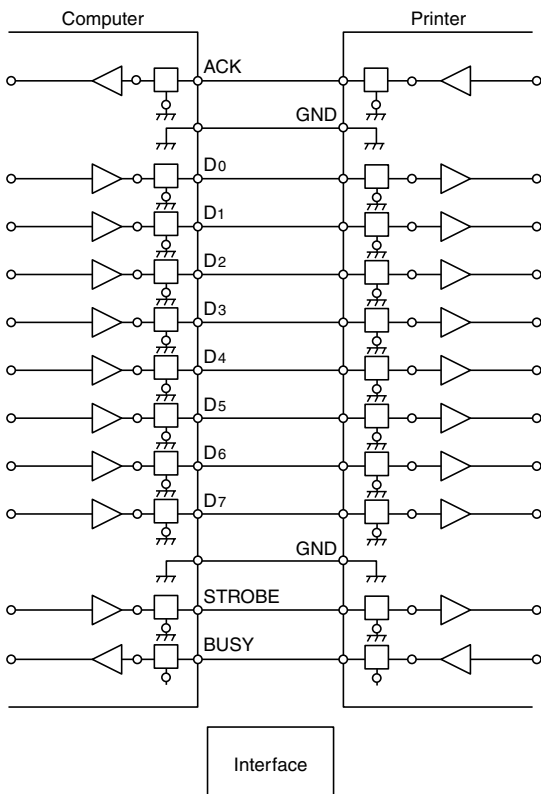

#### EXAMPLES OF MEASURING NOISE SUPPRESSION EFFECT (Waveform spectrum)

##### (1) MEASUREMENT CIRCUIT

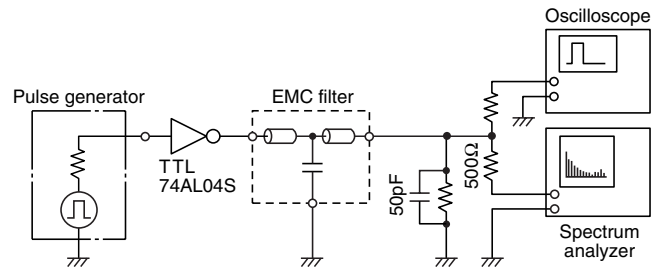

##### PULSE WAVEFORM

##### WITHOUT EMC FILTER

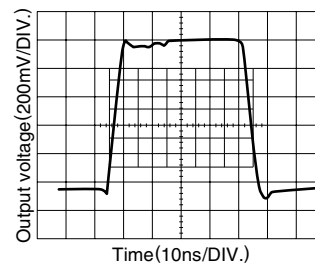

##### WITH EMC FILTER

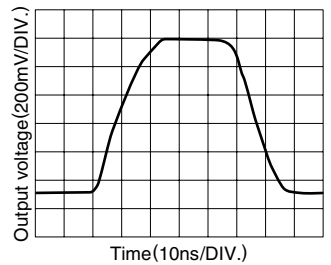

##### (2) MEASUREMENT RESULTS

##### (a) SPECTRUM WITHOUT EMC FILTER

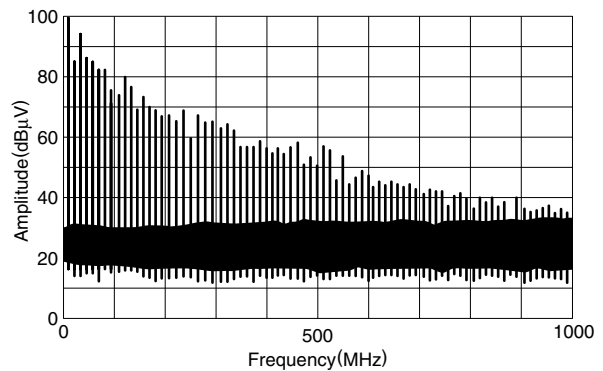

##### (b) SPECTRUM WITH EMC FILTER

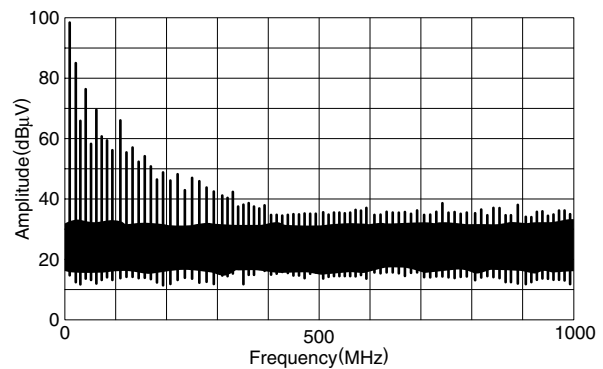

# EMC Components

# ZJSR Series

## 3-Terminal Filters for Signal Line and DC Power Line Lead(Round)

### AN EXAMPLE OF MEASURING NOISE SUPPRESSION EFFECT (Radiation spectrum)

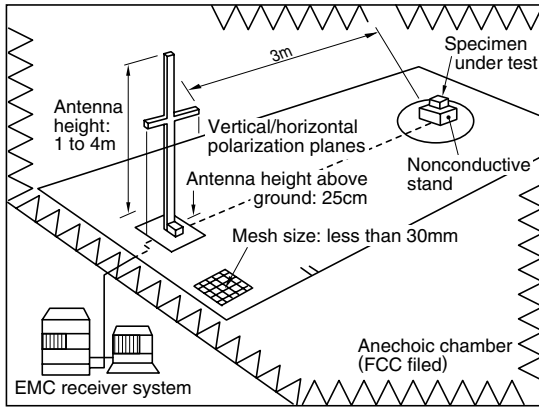

### RADIATION LEVEL (a)WITHOUT EMC FILTER

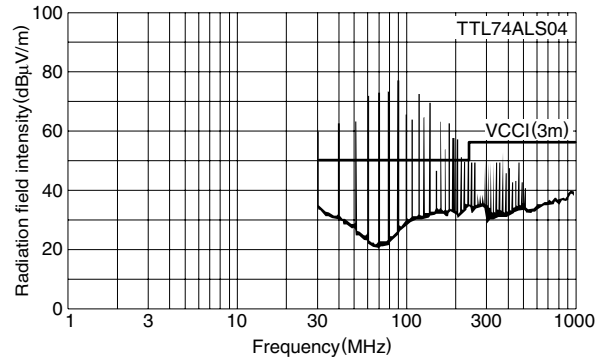

### (b)WITH EMC FILTER

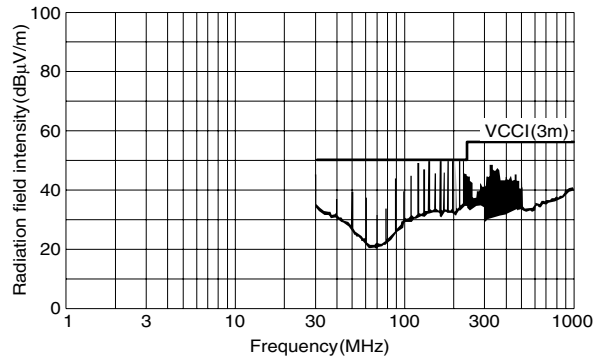

### TTL OUTPUT WAVEFORM WITHIN A SHIELDING CASE

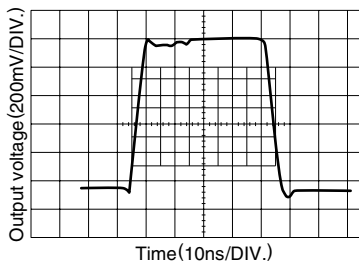

### MODEL

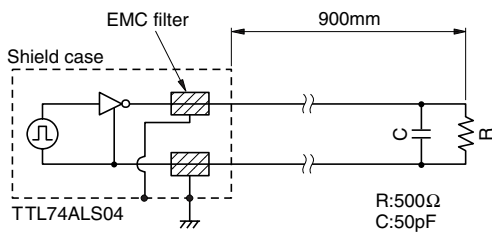

### BICONICAL ANTENNA INDUCED WAVEFORM

