

INTEGRATED CIRCUITS - TTL

(TRANSISTOR TRANSISTOR LOGIC)

NTE74148, NTE74LS148 16-Lead DIP, See Diag. 249
8-Line-to-3-Line Octal, Priority Encoder

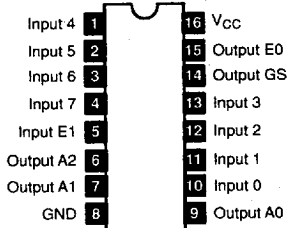

NTE74150 24-Lead DIP, See Diag. 252
1-of-16 Data Selector/Multiplexer

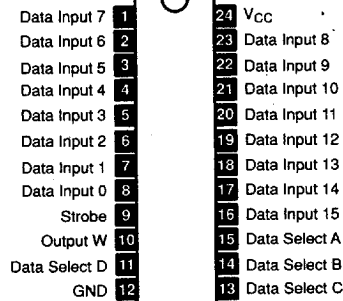

NTE74151, NTE74C151, NTE74HC151, NTE74LS151, NTE74S151 16-Lead DIP, See Diag. 249
8-Channel Multiplexer

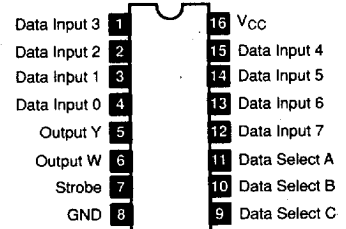

NTE74152 14-Lead DIP, See Diag. 247
1-of-8 Data Selector Multiplexer

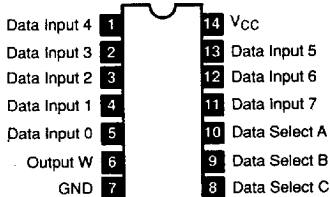

NTE74153, NTE74HC153, NTE74LS153, NTE74S153 16-Lead DIP, See Diag. 249
Dual 4-Line-to-1-Line Data Selector/Multiplexer

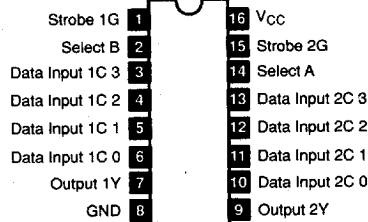

NTE74154, NTE74C154, NTE74HC154 24-Lead DIP, See Diag. 252
4-Line-to-16-Line Decoder/Demultiplexer

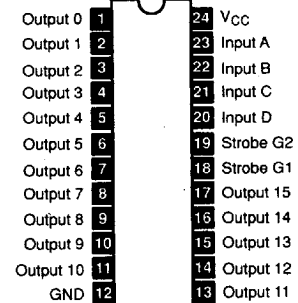

Note: For NTE74HC154 ONLY. See Diag. 581

NTE74155, NTE74LS155, NTE74156, NTE74LS156 16-Lead DIP, See Diag. 249
Dual 2-Line-to-4-Line Decoder/Demultiplexer

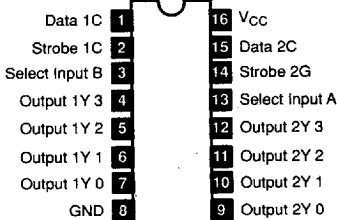

NTE74155, NTE74LS155: Totem Pole Outputs
NTE74156, NTE74LS156: Open Collector Outputs

NTE74157, NTE74C157, NTE74LS157, NTE74S157 16-Lead DIP, See Diag. 249
Quad 2-to-1-Line Data Selector/Multiplexer
*/Non-Inverted Data Outputs

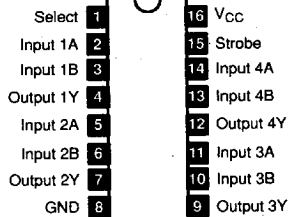

NTE74158, NTE74LS158, NTE74S158 16-Lead DIP, See Diag. 249
Quad 2-to-1-Line Data Selector/Multiplexer
*/Inverted Data Outputs

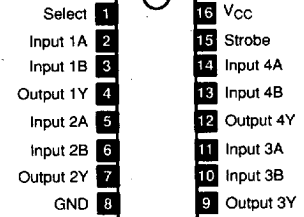

NTE74160, NTE74C160, NTE74LS160A, NTE74161, NTE74C161, NTE74HC161, NTE74HCT161, NTE74LS161A, NTE74162, NTE74LS162A, NTE74163, NTE74HC163, NTE74HCT163, NTE74LS163A, NTE74S163 16-Lead DIP, See Diag. 249
Synchronous 4-Bit Counter

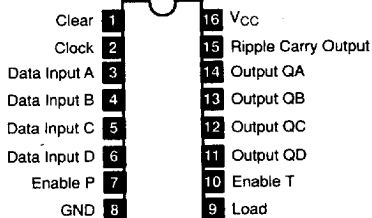

160: Decade, Direct Clear 162: Decade, Synchronous Clear
161: Binary, Direct Clear 163: Binary, Synchronous Clear

NTE74164, NTE74C164, NTE74HC164, NTE74LS164 14-Lead DIP, See Diag. 247
8-Bit Parallel-Out Serial Shift Register
*/Async Clear

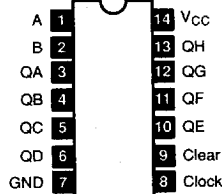

NTE74165, NTE74HC165, NTE74LS165 16-Lead DIP, See Diag. 249
8-Bit Parallel-In/Serial-Out Shift Register

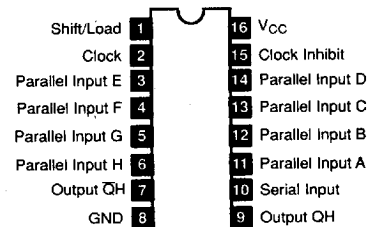

See Diagrams, beginning on Page 1-293