



8Mx64 bits PC100 SDRAM Unbuffered DIMM

based on 8Mx16 SDRAM with LVTTTL, 4 banks & 4K Refresh

HYM71V65801 X-Series

DESCRIPTION

The Hyundai HYM71V65801 X-Series are 8Mx64bits Synchronous DRAM Modules. The modules are composed of four 8Mx16bit CMOS Synchronous DRAMs in 400mil 54pin TSOP-II package, one 2Kbit EEPROM in 8pin TSSOP package on a 168pin glass-epoxy printed circuit board. Two 0.22uF and one 0.0022uF decoupling capacitors per each SDRAM are mounted on the PCB.

The HYM71V65801 X-Series are Dual In-line Memory Modules suitable for easy interchange and addition of 64Mbytes memory. The HYM71V65801 X-Series are offering fully synchronous operation referenced to a positive edge of the clock. All inputs and outputs are synchronized with the rising edge of the clock input. The data paths are internally pipelined to achieve very high bandwidth.

FEATURES

- PC100MHz support
- 168pin SDRAM Unbuffered DIMM
- Serial Presence Detect with EEPROM
- 1.375" (34.93mm) Height PCB with Single Sided components
- Single 3.3 ± 0.3V power supply
- All devices pins are compatible with LVTTTL interface
- Data mask function by DQM
- SDRAM internal banks : four banks
- Module bank : one physical bank
- Auto refresh and self refresh
- 4096 refresh cycles / 64ms
- Programmable Burst Length and Burst Type
 - 1, 2, 4, 8 or Full Page for Sequential Burst
 - 1, 2, 4 or 8 for Interleave Burst
- Programmable /CAS Latency
 - 2, 3 Clocks

ORDERING INFORMATION

PART NO.	MAX. FREQUENCY	INTERNAL BANK	REF.	POWER	SDRAM PACKAGE	PLATING
HYM71V65801TX-8	125MHz	4 Banks	4K	Normal	TSOP-II	Gold
HYM71V65801TX-10P	100MHz					
HYM71V65801TX-10S	100MHz					

This document is a general product description and is subject to change without notice. Hyundai Electronics does not assume any responsibility for use of circuits described. No patent licenses are implied.

PIN DESCRIPTION

PIN NAME	DESCRIPTION	
CK0~CK3	Clock Inputs	The System Clock Input. All other inputs are registered to the SDRAM on the rising edge of CLK.
CKE0	Clock Enable	Controls internal clock signal and when deactivated, the SDRAM will be one of the states among power down, suspend or self refresh.
/S0, /S2	Chip Select	Enables or disables all inputs except CK, CKE and DQM.
BA0, BA1	SDRAM Bank Address	Select bank to be activated during /RAS activity. Select bank to be read/written during /CAS activity
A0~A11	Address Inputs	Row address : RA0~RA11, Column address : CA0~CA8 Auto-precharge flag : A10
/RAS	Row Address Strobe	/RAS define the operation. Refer to the function truth table for details.
/CAS	Column Address Strobe	/CAS define the operation. Refer to the function truth table for details.
/WE	Write Enable	/WE define the operation. Refer to the function truth table for details.
DQM0~DQM7	Data Input/Output Mask	Controls output buffers in read mode and masks input data in write mode.
DQ0~DQ63	Data Input/Output	Multiplexed data input/output pins
VCC	Power Supply (3.3V)	Power supply for internal circuits and input/output buffers
VSS	Ground	Ground
SCL	SPD Clock Input	Serial Presence Detect Clock Input
SDA	SPD Data Input/Output	Serial Presence Detect Data input/output
SA0~SA2	SPD Address Input	Serial Presence Detect Address input
WP	Write Protect for SPD	Write Protect for Serial Presence Detect on DIMM
NC	No Connect	No Connect or Don't Use

PIN ASSIGNMENTS

FRONT SIDE		BACK SIDE		FRONT SIDE		BACK SIDE	
PIN NO.	NAME	PIN NO.	NAME	PIN NO.	NAME	PIN NO.	NAME
1	VSS	85	VSS	41	VCC	125	*CK1
2	DQ0	86	DQ32	42	CK0	126	NC
3	DQ1	87	DQ33	43	VSS	127	VSS
4	DQ2	88	DQ34	44	NC	128	CKE0
5	DQ3	89	DQ35	45	/S2	129	NC
6	VCC	90	VCC	46	DQM2	130	DQM6
7	DQ4	91	DQ36	47	DQM3	131	DQM7
8	DQ5	92	DQ37	48	NC	132	NC
9	DQ6	93	DQ38	49	VCC	133	VCC
10	DQ7	94	DQ39	50	NC	134	NC
Architecture Key				51	NC	135	NC
				52	NC	136	NC
11	DQ8	95	DQ40	53	NC	137	NC
12	VSS	96	VSS	54	VSS	138	VSS
13	DQ9	97	DQ41	55	DQ16	139	DQ48
14	DQ10	98	DQ42	56	DQ17	140	DQ49
15	DQ11	99	DQ43	57	DQ18	141	DQ50
16	DQ12	100	DQ44	58	DQ19	142	DQ51
17	DQ13	101	DQ45	59	VCC	143	VCC
18	VCC	102	VCC	60	DQ20	144	DQ52
19	DQ14	103	DQ46	61	NC	145	NC
20	DQ15	104	DQ47	62	NC	146	NC
21	NC	105	NC	63	NC	147	NC
22	NC	106	NC	64	VSS	148	VSS
23	VSS	107	VSS	65	DQ21	149	DQ53
24	NC	108	NC	66	DQ22	150	DQ54
25	NC	109	NC	67	DQ23	151	DQ55
26	VCC	110	VCC	68	VSS	152	VSS
27	/WE	111	/CAS	69	DQ24	153	DQ56
28	DQM0	112	DQM4	70	DQ25	154	DQ57
29	DQM1	113	DQM5	71	DQ26	155	DQ58
30	/S0	114	NC	72	DQ27	156	DQ59
31	NC	115	/RAS	73	VCC	157	VCC
32	VSS	116	VSS	74	DQ28	158	DQ60
33	A0	117	A1	75	DQ29	159	DQ61
34	A2	118	A3	76	DQ30	160	DQ62
35	A4	119	A5	77	DQ31	161	DQ63
36	A6	120	A7	78	VSS	162	VSS
37	A8	121	A9	79	CK2	163	*CK3
38	A10/AP	122	BA0	80	NC	164	NC
39	BA1	123	A11	81	WP	165	SA0
40	VCC	124	VCC	82	SDA	166	SA1
Voltage Key				83	SCL	167	SA2
				84	VCC	168	VCC

Note : *. CK1, CK3 are connected with termination R/C. (Refer to the Block Diagram.)

BLOCK DIAGRAM

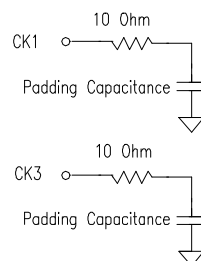
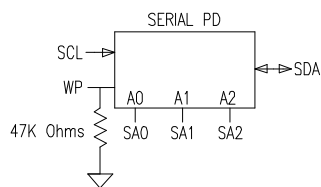
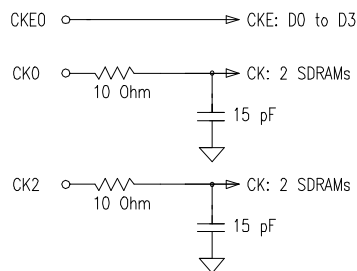
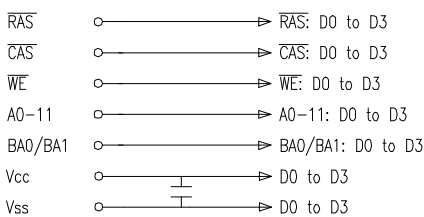
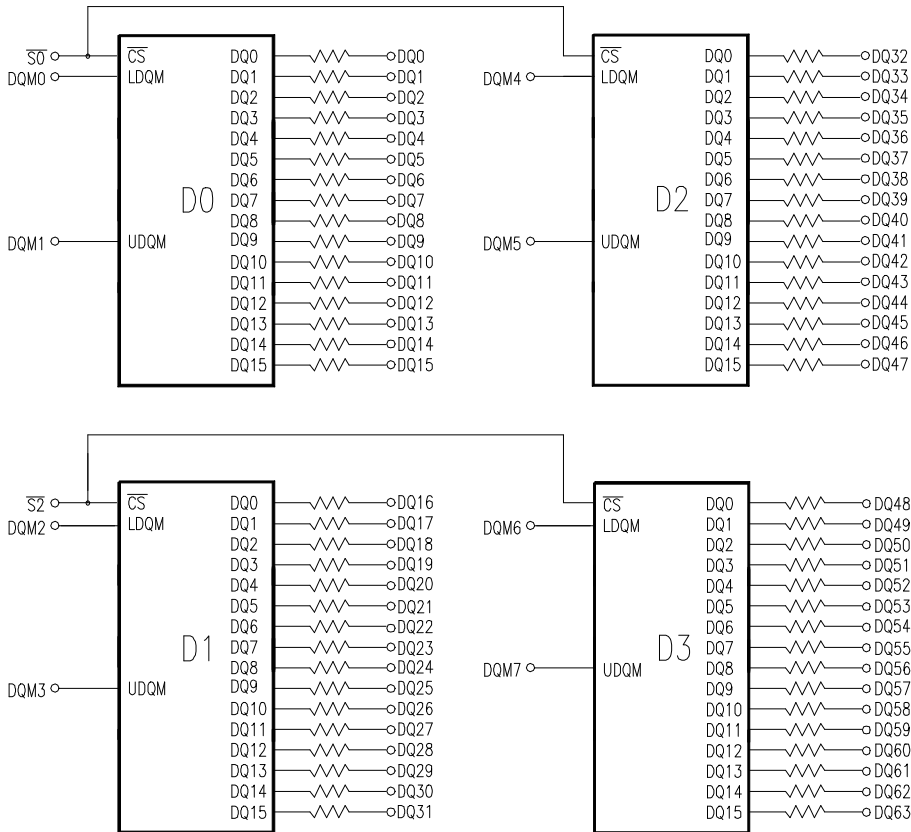

Note : 1. The serial resistor values of DQs are 10 Ohms.
2. The padding capacitance of termination R/C for CK1, CK3 is 10pF.

SERIAL PRESENCE DETECT

BYTE NUMBER	FUNCTION DESCRIBED	FUNCTION			VALUE			NOTE
		-8	-10P	-10S	-8	-10P	-10S	
BYTE0	# of Bytes Written into Serial Memory at Module Manufacturer	128 Bytes			80h			
BYTE1	Total # of Bytes of SPD Memory Device	256 Bytes			08h			
BYTE2	Fundamental Memory Type	SDRAM			04h			
BYTE3	# of Row Addresses on This Assembly	12			0Ch			1
BYTE4	# of Column Addresses on This Assembly	9			09h			
BYTE5	# of Module Banks on This Assembly	1 Banks			01h			
BYTE6	Data Width of This Assembly	64 Bits			40h			
BYTE7	Data Width of This Assembly (Continued)	-			00h			
BYTE8	Voltage Interface Standard of This Assembly	LVTTL			01h			
BYTE9	SDRAM Cycle Time @ /CAS Latency=3	8ns	10ns	10ns	80h	A0h	A0h	
BYTE10	Access Time from Clock @ /CAS Latency=3	6ns	6ns	6ns	60h	60h	60h	
BYTE11	DIMM Configuration Type	None			00h			
BYTE12	Refresh Rate/Type	15.625µs / Self Refresh Supported			80h			
BYTE13	Primary SDRAM Width	x16			10h			
BYTE14	Error Checking SDRAM Width	None			00h			
BYTE15	Minimum Clock Delay Back to Back Random Column Address	tCCD = 1 CLK			01h			
BYTE16	Burst Lengths Supported	1,2,4,8,Full Page			8Fh			2
BYTE17	# of Banks on Each SDRAM Device	4 Banks			04h			
BYTE18	SDRAM Device Attributes, CAS # Latency	/CAS Latency=2,3			06h			
BYTE19	SDRAM Device Attributes, CS # Latency	/CS Latency=0			01h			
BYTE20	SDRAM Device Attributes, Write Latency	/WE Latency=0			01h			
BYTE21	SDRAM Module Attributes	Neither Buffered nor Registered			00h			
BYTE22	SDRAM Device Attributes, General	+/-10% voltage tolerance, Burst Read Single bit Write, Precharge All, Auto Precharge, Early RAS Precharge			0Eh			
BYTE23	SDRAM Cycle Time @ /CAS Latency=2	10ns	10ns	12ns	A0h	A0h	C0h	
BYTE24	Access Time from Clock @ /CAS Latency=2	6ns	6ns	6ns	60h	60h	60h	
BYTE25	SDRAM Cycle Time @ /CAS Latency=1	-	-	-	00h	00h	00h	
BYTE26	Access Time from Clock @ /CAS Latency=1	-	-	-	00h	00h	00h	
BYTE27	Minimum Row Precharge Time (tRP)	20ns	20ns	20ns	14h	14h	14h	
BYTE28	Minimum Row Active to Row Active Delay (tRRD)	16ns	20ns	20ns	10h	14h	14h	
BYTE29	Minimum /RAS to /CAS Delay (tRCD)	20ns	20ns	20ns	14h	14h	14h	
BYTE30	Minimum /RAS Pulse width (tRAS)	48ns	50ns	50ns	30h	32h	32h	
BYTE31	Module Bank Density	64MB			10h			
BYTE32	Command and Address Signal Input Setup Time	2ns	2ns	2ns	20h	20h	20h	
BYTE33	Command and Address Signal Input Hold Time	1ns	1ns	1ns	10h	10h	10h	
BYTE34	Data Signal Input Setup Time	2ns	2ns	2ns	20h	20h	20h	
BYTE35	Data Signal Input Hold Time	1ns	1ns	1ns	10h	10h	10h	
BYTE36 -61	Superset Information (may be used in future)	-			00h			
BYTE62	SPD Revision	Intel SPD 1.2A			12h			3, 8
BYTE63	Checksum for Bytes 0-62	-			E7h	0Dh	2Dh	
BYTE64	Manufacturer JEDEC ID Code	Hyundai JEDEC ID			ADh			
BYTE65 -71Manufacturer JEDEC ID Code	Unused			FFh			
BYTE72	Manufacturing Location	HEI (Korea) HEA (United States) HEU (Europe)			01h 02h 03h			

Continued

BYTE NUMBER	FUNCTION DESCRIBED	FUNCTION			VALUE			NOTE
		-8	-10P	-10S	-8	-10P	-10S	
BYTE73	Manufacturer' s Part Number (Component)	7 (SDRAM)			37h			4, 5
BYTE74	Manufacturer' s Part Number (128Mb based)	1			31h			4, 5
BYTE75	Manufacturer' s Part Number (Voltage Interface)	V (3.3V, LVTTTL)			56h			4, 5
BYTE76	Manufacturer' s Part Number (Data Width)	6			36h			4, 5
BYTE77Manufacturer' s Part Number (Data Width)	5			35h			4, 5
BYTE78	Manufacturer' s Part Number (Memory Depth)	8			38h			4, 5
BYTE79	Manufacturer' s Part Number (Refresh)	0 (4K Refresh)			30h			4, 5
BYTE80	Manufacturer' s Part Number (Internal Banks)	1 (4 Banks)			31h			4, 5
BYTE81	Manufacturer' s Part Number (Package Type)	T (TSOPII)			54h			4, 5
BYTE82	Manufacturer' s Part Number (Module Type)	X (x16 based)			58h			4, 5
BYTE83	Manufacturer' s Part Number (Hyphen)	- (Hyphen)			2Dh			4, 5
BYTE84	Manufacturer' s Part Number (Min. Cycle Time)	8	1	1	38h	31h	31h	4, 5
BYTE85Manufacturer' s Part Number (Min. Cycle Time)	Blank	0	0	20h	30h	30h	4, 5
BYTE86Manufacturer' s Part Number (Min. Cycle Time)	Blank	P	S	20h	50h	53h	4, 5
BYTE87 ~90	Manufacturer' s Part Number	Blanks			20h			4, 5
BYTE91	Revision Code (for Component)	Process Code			-			4, 6
BYTE92Revision Code (for PCB)	Process Code			-			4, 6
BYTE93	Manufacturing Date	Work Week			-			3, 6
BYTE94Manufacturing Date	Year			-			3, 6
BYTE95 ~98	Assembly Serial Number	Serial Number			-			6
BYTE99 ~125	Manufacturer Specific Data (may be used in future)	None			00h			
BYTE126	System Frequency Support	100MHz			64h			8
BYTE127	Intel Specification Details for 100MHz Support	Refer to Note7			A7h	A7h	A5h	7, 8
BYTE128 ~256	Unused Storage Locations	-			00h			

- Note:**
1. The bank address is excluded.
 2. 1,2,4,8 for Interleave Burst Type.
 3. BCD adopted.
 4. ASCII adopted.
 5. Basically HYUNDAI writes Part No. except for `HYM` in Byte 73-90 to use the limited 18 bytes from byte 73 to 90 efficiently.
 6. Not fixed but dependent.
 7. CLK0, CLK2 connected on the DIMM, TBD junction temp, CL2(3) support, Intel defined Concurrent Auto Precharge support.
 8. Refer to Intel SPD Specification Rev.1.2A.

ABSOLUTE MAXIMUM RATINGS

PARAMETER	SYMBOL	RATING	UNIT
Ambient Temperature	TA	0 ~ 70	°C
Storage Temperature	TSTG	-55 ~ 125	°C
Voltage on any Pin relative to VSS	VIN, VOUT	-1.0 ~ 4.6	V
Voltage on VDD relative to VSS	VDD, VDDQ	-1.0 ~ 4.6	V
Short Circuit Output Current	IOS	50	MA
Power Dissipation	PD	4	W
Soldering Temperature · Time	TSOLDER	260 · 10	°C · Sec

Note : Operation at above absolute maximum can adversely affect device reliability.

DC OPERATING CONDITION

(TA = 0 to 70°C)

PARAMETER	SYMBOL	MIN	TYP.	MAX	UNIT	NOTE
Power Supply Voltage	VCC	3.0	3.3	3.6	V	1
Input High Voltage	VIH	2.0	3.0	VCC + 0.3	V	1, 2
Input Low Voltage	VIL	-0.3	0	0.8	V	1, 3

- Note :**
1. All voltage are referenced to VSS = 0V.
 2. VIH (max) is acceptable 5.6V AC pulse width with ≤ 3 ns of duration.
 3. VIL (min) is acceptable -2.0V AC pulse width with ≤ 3 ns of duration.

AC OPERATING CONDITION

(TA = 0 to 70°C, VDD = 3.3 ± 0.3V, VSS = 0V)

PARAMETER	SYMBOL	VALUE	UNIT
AC Input High / Low Level Voltage	VIH / VIL	2.4 / 0.4	V
Input Timing Measurement Reference Level Voltage	Vtrip	1.4	V
Input Rise / Fall Time	tR / tF	1	ns
Output Timing Measurement Reference Level Voltage	Voutref	1.4	V
Output Load Capacitance for Access Time Measurement	CL	*Note	pF

Note : *. Output load to measure access time is equivalent to two TTL gates and one capacitor (50pF).
For details, refer to AC/DC output circuit.

CAPACITANCE

(TA = 25°C, f = 1MHz)

PARAMETER	PIN	SYMBOL	MIN	MAX	TYP.	UNIT
Input Capacitance	CK0, CK2	CIN1	15	45	-	pF
	CKE0	CIN2	25	40	-	pF
	/S0, /S2	CIN3	15	30	-	pF
	A0~A11, BA0, BA1	CIN4	30	45	-	pF
	/RAS, /CAS, /WE	CIN5	30	45	-	pF
	DQM0~DQM7	CIN6	5	20	-	pF
Data Input/Output Capacitance	DQ0~DQ63	CI/O	5	20	-	pF

OUTPUT LOAD CIRCUIT

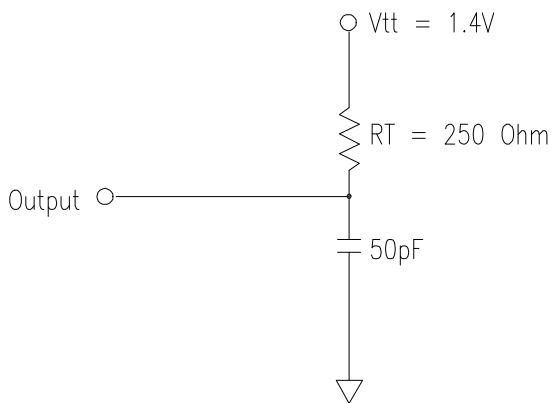

DC Output Load Circuit

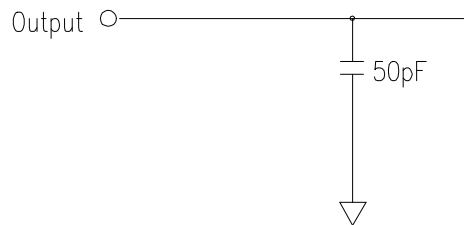

AC Output Load Circuit

DC CHARACTERISTICS I

(TA = 0 to 70°C, VDD = 3.3 ± 0.3V)

PARAMETER	SYMBOL	MIN	MAX	UNIT	NOTE
Input Leakage Current	ILI	-4	4	uA	1
Output Leakage Current	ILO	-1	1	uA	2
Output High Voltage	VOH	2.4	-	V	IOH = -4mA
Output Low Voltage	VOL	-	0.4	V	IOL = +4mA

Note : 1. VIN = 0 to 3.6V. All other pins are not tested under VIN = 0V.
2. DOUT is disabled. VOUT = 0 to 3.6V.

DC CHARACTERISTICS II

(TA = 0 to 70°C, VDD = 3.3 ± 0.3V, VSS = 0V)

PARAMETER	SYMBOL	TEST CONDITION	SPEED			UNIT	NOTE	
			-8	-10P	-10S			
Operating Current	IDD1	Burst Length = 1, One bank active tRC ≥ tRC(min), IOL = 0mA	480	480	480	mA	1	
Precharge Standby Current in Power Down Mode	IDD2P	CKE ≤ VIL(max), tCK = min	8			mA		
	IDD2PS	CKE ≤ VIL(max), tCK = ∞	6			mA		
Precharge Standby Current in Non Power Down Mode	IDD2N	CKE ≥ VIH(min), /CS ≥ VIH(min), tCK = min Input signals are changed one time during 2clks. All other pins ≥ VDD - 0.2V or ≤ 0.2V	80			mA		
	IDD2NS	CKE ≥ VIH(max), tCK = ∞ Input signals are stable.	40			mA		
Active Standby Current in Power Down Mode	IDD3P	CKE ≤ VIL(max), tCK = min	28			mA		
	IDD3PS	CKE ≤ VIL(max), tCK = ∞	28			mA		
Active Standby Current in Non Power Down Mode	IDD3N	CKE ≥ VIH(min), /CS ≥ VIH(min), tCK = min Input signals are changed one time during 2clks. All other pins ≥ VDD - 0.2V or ≤ 0.2V	160			mA		
	IDD3NS	CKE ≥ VIH(max), tCK = ∞ Input signals are stable.	160			mA		
Burst Mode Operating Current	IDD4	tCK ≥ tCK(min), IOL = 0mA All banks active	CL = 3	600	480	480	mA	1
			CL = 2	480	480	440		
Auto Refresh Current	IDD5	tRRC ≥ tRRC(min), All banks active	1160			mA	2	
Self Refresh Current	IDD6	CKE ≤ 0.2V	8			mA		

Note : 1. IDD1 and IDD4 depend on output loading and cycle rates. Specified values are measured with the output open.
2. Min. of tRRC (Refresh /RAS cycle time) is shown at AC CHARACTERISTICS II.

AC CHARACTERISTICS I

(AC operating conditions unless otherwise noted)

PARAMETER		SYMBOL	-8		-10P		-10S		UNIT	NOTE
			MIN	MAX	MIN	MAX	MIN	MAX		
System Clock Cycle Time	/CAS Latency = 3	tCK3	8	1000	10	1000	10	1000	ns	
	/CAS Latency = 2	tCK2	10		10		12			
Clock High Pulse Width		tCHW	3	-	3	-	3	-	ns	1
Clock Low Pulse Width		tCLW	3	-	3	-	3	-	ns	1
Access Time from Clock	/CAS Latency = 3	tAC3	-	6	-	6	-	6	ns	2
	/CAS Latency = 2	tAC2	-	6	-	6	-	6		
Data-Out Hold Time		tOH	3	-	3	-	3	-	ns	
Data-Input Setup Time		tDS	2	-	2	-	2	-	ns	1
Data-Input Hold Time		tDH	1	-	1	-	1	-	ns	1
Address Setup Time		tAS	2	-	2	-	2	-	ns	1
Address Hold Time		tAH	1	-	1	-	1	-	ns	1
CKE Setup Time		tCKS	2	-	2	-	2	-	ns	1
CKE Hold Time		tCKH	1	-	1	-	1	-	ns	1
Command Setup Time		tCS	2	-	2	-	2	-	ns	1
Command Hold Time		tCH	1	-	1	-	1	-	ns	1
CLK to Data Output in Low-Z time		tOLZ	1	-	1	-	1	-	ns	
CLK to Data Output in High-Z time	/CAS Latency = 3	tOHZ3	3	6	3	6	3	6	ns	
	/CAS Latency = 2	tOHZ2	3	6	3	6	3	6		

Note :

1. Assume t_R / t_F (input rise and fall time) is 1ns. If $t_R \& t_F > 1ns$, then $[(t_R+t_F)/2-1]ns$ should be added to the parameter
2. Access times to be measured with input signals of 1v/ns edge rate, from 0.8v to 2.0v.
If $t_R > 1ns$, then $(t_R/2-0.5)ns$ should be added to the parameter

AC CHARACTERISTICS II

PARAMETER		SYMBOL	-8		-10P		-10S		UNIT	NOTE
			MIN	MAX	MIN	MAX	MIN	MAX		
/RAS Cycle Time	Operation	tRC	68	-	70	-	70	-	ns	
	Auto Refresh	tRRC	68		70		70			
/RAS to /CAS Delay		tRCD	20	-	20	-	20	-	ns	
/RAS Active Time		tRAS	48	100K	50	100K	50	100K	ns	
/RAS Precharge Time		tRP	20	-	20	-	20	-	ns	
/RAS to /RAS Bank Active Delay		tRRD	16	-	20	-	20	-	ns	
/CAS to /CAS Delay		tCCD	1	-	1	-	1	-	CLK	
Write Command to Data-in Delay		tWTL	0	-	0	-	0	-	CLK	
Data-in to Precharge Command		tDPL	1	-	1	-	1	-	CLK	
Data-in to Active Command		tDAL	4	-	3	-	3	-	CLK	
DQM to Data-out Hi-Z		tDQZ	2	-	2	-	2	-	CLK	
DQM to Data-in Mask		tDQM	0	-	0	-	0	-	CLK	
MRS to New Command		tMRD	2	-	2	-	2	-	CLK	
Precharge to Data Output Hi-Z	/CAS Latency = 3	tPROZ3	3	-	3	-	3	-	CLK	
	/CAS Latency = 2	tPROZ2	2	-	2	-	2	-		
Power Down Exit Time		tPDE	1	-	1	-	1	-	CLK	
Self Refresh Exit Time		tSRE	1	-	1	-	1	-	CLK	1
Refresh Time		tREF	-	64	-	64	-	64	ms	

Note : 1. A new command can be given tRRC after self refresh exit.

OPERATING OPTION TABLE**HYM71V65801TX-8**

	/CAS LATENCY	tRCD	tRAS	tRC	tRP	tAC	tOH
125MHz (8.0ns)	3CLKS	3CLKS	6CLKS	9CLKS	3CLKS	6ns	3ns
100MHz (10.0ns)	2CLKS	2CLKS	5CLKS	7CLKS	2CLKS	6ns	3ns
83MHz (12.0ns)	2CLKS	2CLKS	4CLKS	6CLKS	2CLKS	6ns	3ns

HYM71V65801TX-10P

	/CAS LATENCY	tRCD	tRAS	tRC	tRP	tAC	tOH
100MHz (10.0ns)	2CLKS	2CLKS	5CLKS	7CLKS	2CLKS	6ns	3ns
83MHz (12.0ns)	2CLKS	2CLKS	5CLKS	7CLKS	2CLKS	6ns	3ns
66MHz (15.0ns)	2CLKS	2CLKS	4CLKS	6CLKS	2CLKS	6ns	3ns

HYM71V65801TX-10S

	/CAS LATENCY	tRCD	tRAS	tRC	tRP	tAC	tOH
100MHz (10.0ns)	3CLKS	2CLKS	5CLKS	7CLKS	2CLKS	6ns	3ns
83MHz (12.0ns)	2CLKS	2CLKS	5CLKS	7CLKS	2CLKS	6ns	3ns
66MHz (15.0ns)	2CLKS	2CLKS	4CLKS	6CLKS	2CLKS	6ns	3ns

COMMAND TRUTH TABLE

	CKEn-1	CKEn	/CS	/RAS	/CAS	/WE	DQM	ADDR	A10/ AP	BA	NOTE	
Mode Register Set	H	X	L	L	L	L	X	OP code				
No Operation	H	X	H	X	X	X	X	X				
			L	H	H	H						
Bank Active	H	X	L	L	H	H	X	RA		V		
Read	H	X	L	H	L	H	X	CA	L	V		
Read with Autoprecharge									H			
Write	H	X	L	H	L	L	X	CA	L	V		
Write with Autoprecharge									H			
Precharge All Banks	H	X	L	L	H	L	X	X	H	X		
Precharge Selected Bank									L	V		
Burst Stop	H	X	L	H	H	L	X	X				
DQM	H	X					V	X				
Auto Refresh	H	H	L	L	L	H	X	X				
Self Refresh	Entry	H	L	L	L	L	H	X	X			1
	Exit	L	H	H	X	X	X	X				
L				H	H	H						
Precharge Power Down	Entry	H	L	H	X	X	X	X	X			
				L	H	H	H					
Exit	L	H	H	X	X	X	X	X				
			L	H	H	H						
Clock Suspend	Entry	H	L	H	X	X	X	X	X			
				L	V	V	V					
Exit	L	H	X				X					

Note : 1. Existing Self Refresh occurs by asynchronously bringing CKE from low to high.

2. X = Don't care, H = Logic High, L = logic Low, BA = Bank Address, CA = Column Address, OP code = Operand code, NOP = No operation

PACKAGE DIMENSIONS

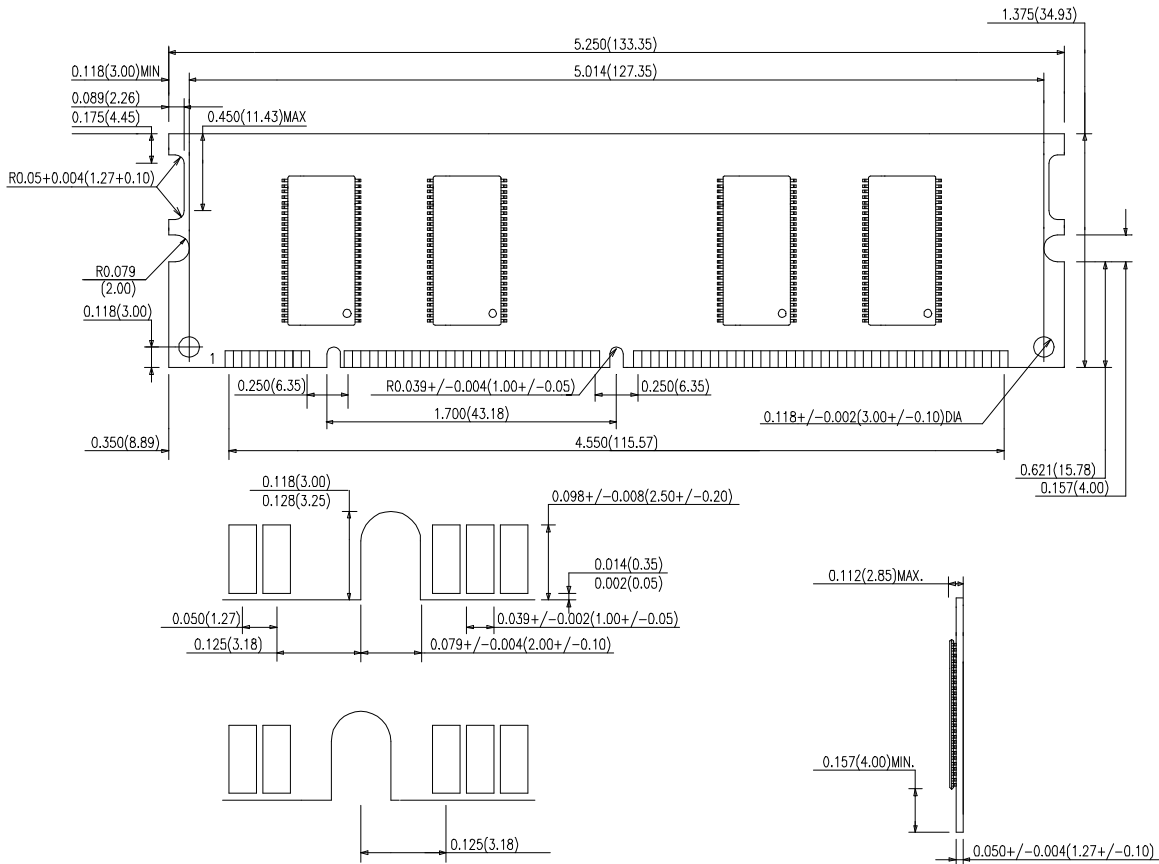

UNIT : INCH(mm)
TOLERANCE : +/-0.005(0.13)