

User Guide for  
FEBFL7733A\_L52U050A  
Evaluation Board

50 W LED Driver with Ultra-Wide Output  
Voltage Range at Universal Line

Featured Fairchild Product:  
FL7733A

***Direct questions or comments  
about this evaluation board to:  
“Worldwide Direct Support”***

**[Fairchild Semiconductor.com](http://Fairchild Semiconductor.com)**

## Table of Contents

1. Introduction .....	3
1.1. General Description of FL7733A .....	3
1.2. Controller Features .....	3
1.3. Controller Internal Block Diagram .....	4
2. Evaluation Board Specifications .....	5
3. Evaluation Board Photographs .....	6
4. Evaluation Board Printed Circuit Board (PCB) .....	7
5. Evaluation Board Schematic .....	8
6. Evaluation Board Bill of Materials .....	9
7. Transformer Design .....	11
8. Evaluation Board Performance .....	12
8.1. Startup .....	13
8.2. Operation Waveforms .....	14
8.3. Constant-Current Regulation .....	16
8.4. Short- / Open-LED Protections .....	19
8.5. Efficiency .....	21
8.6. Power Factor (PF) & Total Harmonic Distortion (THD) .....	22
8.7. Harmonics .....	23
8.8. Operating Temperature .....	25
8.9. Electromagnetic Interference (EMI) .....	26
9. Revision History .....	27

This user guide supports the evaluation kit for the FL7733A. It should be used in conjunction with the FL7733A datasheet as well as Fairchild's application notes and technical support team. Please visit Fairchild's website at [www.fairchildsemi.com](http://www.fairchildsemi.com).

## 1. Introduction

This document describes a solution for an universal AC input voltage LED driver using the FL7733A Primary-Side Regulation (PSR) single-stage controller. The input voltage range is  $90 V_{RMS} \sim 277 V_{RMS}$  and there is one DC output with a constant current of 1.0 A at 50 V. This document contains a general description of the FL7733A, the power supply solution specification, schematic, bill of materials, and typical operating characteristics.

### 1.1. General Description of FL7733A

The FL7733A is an active Power Factor Correction (PFC) controller for use in single-stage flyback topology or buck-boost topology. Primary-side regulation and single-stage topology minimize cost by reducing external components such as the input bulk capacitor and secondary side feedback circuitry. To improve power factor and Total Harmonic Distortion (THD), constant on-time control is utilized with an internal error amplifier and a low bandwidth compensator. Precise constant-current control provides accurate output current, independent of input voltage and output voltage. Operating frequency is proportionally changed by the output voltage to guarantee Discontinuous Current Mode (DCM) operation, resulting in high efficiency and simple designs. The FL7733A also provides open-LED, short-LED, and over-temperature protection functions.

### 1.2. Controller Features

#### High Performance

- Cost Effective Solution without requiring the use of an Input Bulk Capacitor and Secondary-Side Feedback Circuitry
- Power Factor Correction
- THD <10% over Universal Line Range
- CC Tolerance:
  - <  $\pm 1\%$  by Universal Line Voltage Variation
  - <  $\pm 1\%$  by 50% ~ 100% Load Voltage Variation
  - <  $\pm 1\%$  by  $\pm 20\%$  Magnetizing Inductance Variation
- High-Voltage Startup with  $V_{DD}$  Regulation
- Adaptive Feedback Loop Control for Startup without Overshoot

#### High Reliability

- LED Short / Open Protection
- Output Diode Short Protection
- Sensing Resistor Short / Open Protection
- $V_{DD}$  Over-Voltage Protection (OVP)
- $V_{DD}$  Under-Voltage Lockout (UVLO)
- Over-Temperature Protection (OTP)
- All Protections by Auto Restart
- Cycle-by-Cycle Current Limit
- Application Voltage Range:  $80 V_{AC} \sim 308 V_{AC}$

### 1.3. Controller Internal Block Diagram

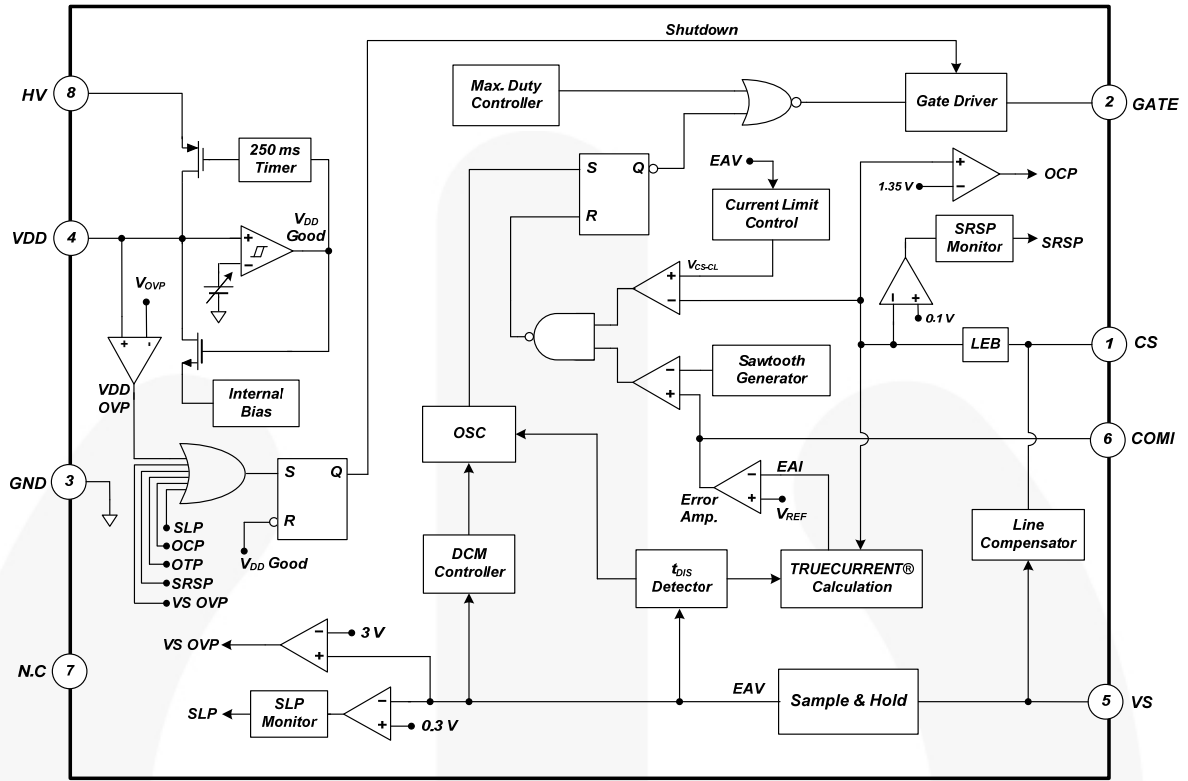

Figure 1. Block Diagram of the FL7733A

## 2. Evaluation Board Specifications

**Table 1. Specifications for LED Lighting Load**

Description		Symbol	Value	Comments
Input	Voltage	$V_{IN.MIN}$	90 V <sub>AC</sub>	Minimum AC Input Voltage
		$V_{IN.MAX}$	277 V <sub>AC</sub>	Maximum AC Input Voltage
		$V_{IN.NOMINAL}$	120 V / 230 V	Nominal AC Input Voltage
	Frequency	$f_{IN}$	60 Hz / 50 Hz	Line Frequency
Output	Voltage	$V_{OUT.MIN}$	7 V	Minimum Output Voltage
		$V_{OUT.MAX}$	55 V	Maximum Output Voltage
		$V_{OUT.NOMINAL}$	50 V	Nominal Output Voltage
	Current	$I_{OUT.NOMINAL}$	1.0 A	Nominal Output Current
		CC Deviation	< ±0.85%	Line Input Voltage Change: 90~277 V <sub>AC</sub>
			< ±1.75%	Output Voltage Change: 7~55 V
Efficiency	$Eff_{90VAC}$	87.56%	Efficiency at 90 V <sub>AC</sub> Input Voltage	
	$Eff_{120VAC}$	88.96%	Efficiency at 120 V <sub>AC</sub> Input Voltage	
	$Eff_{140VAC}$	89.49%	Efficiency at 140 V <sub>AC</sub> Input Voltage	
	$Eff_{180VAC}$	90.13%	Efficiency at 180 V <sub>AC</sub> Input Voltage	
	$Eff_{230VAC}$	90.31%	Efficiency at 230 V <sub>AC</sub> Input Voltage	
	$Eff_{277VAC}$	90.26%	Efficiency at 277 V <sub>AC</sub> Input Voltage	
PF / THD	$PF / THD_{90VAC}$	0.997 / 3.36%	PF/THD at 90 V <sub>AC</sub> Input Voltage	
	$PF / THD_{120VAC}$	0.992 / 3.55%	PF/THD at 120 V <sub>AC</sub> Input Voltage	
	$PF / THD_{140VAC}$	0.987 / 3.60%	PF/THD at 140 V <sub>AC</sub> Input Voltage	
	$PF / THD_{180VAC}$	0.975 / 4.44%	PF/THD at 180 V <sub>AC</sub> Input Voltage	
	$PF / THD_{230VAC}$	0.944 / 5.36%	PF/THD at 230 V <sub>AC</sub> Input Voltage	
	$PF / THD_{277VAC}$	0.902 / 6.88%	PF/THD at 277 V <sub>AC</sub> Input Voltage	
Temperature	<b>FL7733A</b>	$T_{FL7733A}$	57.9°C	Open-Frame Condition ( $T_A = 25^\circ C$ ) FL7733A Temperature
	<b>Primary MOSFET</b>	$T_{MOSFET}$	66.1°C	Primary MOSFET Temperature
	<b>Secondary Diode</b>	$T_{DIODE}$	65.2°C	Secondary Diode Temperature
	<b>Bridge Diode</b>	$T_{BRG-DIODE}$	60.1°C	Bridge Diode Temperature

All data of the evaluation board measured with the board was enclosed in a case and external temperature around  $T_A=25^\circ C$ .

### 3. Evaluation Board Photographs

Dimensions: 168 mm (L) x 35 mm (W) x 25 mm (H)



Figure 2. Top View



Figure 3. Bottom View



Figure 4. Side View

#### 4. Evaluation Board Printed Circuit Board (PCB)



Figure 5. Top Pattern

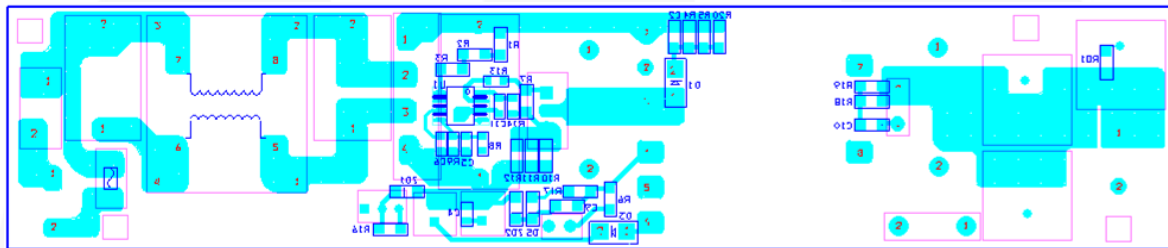

Figure 6. Bottom Patte

## 5. Evaluation Board Schematic

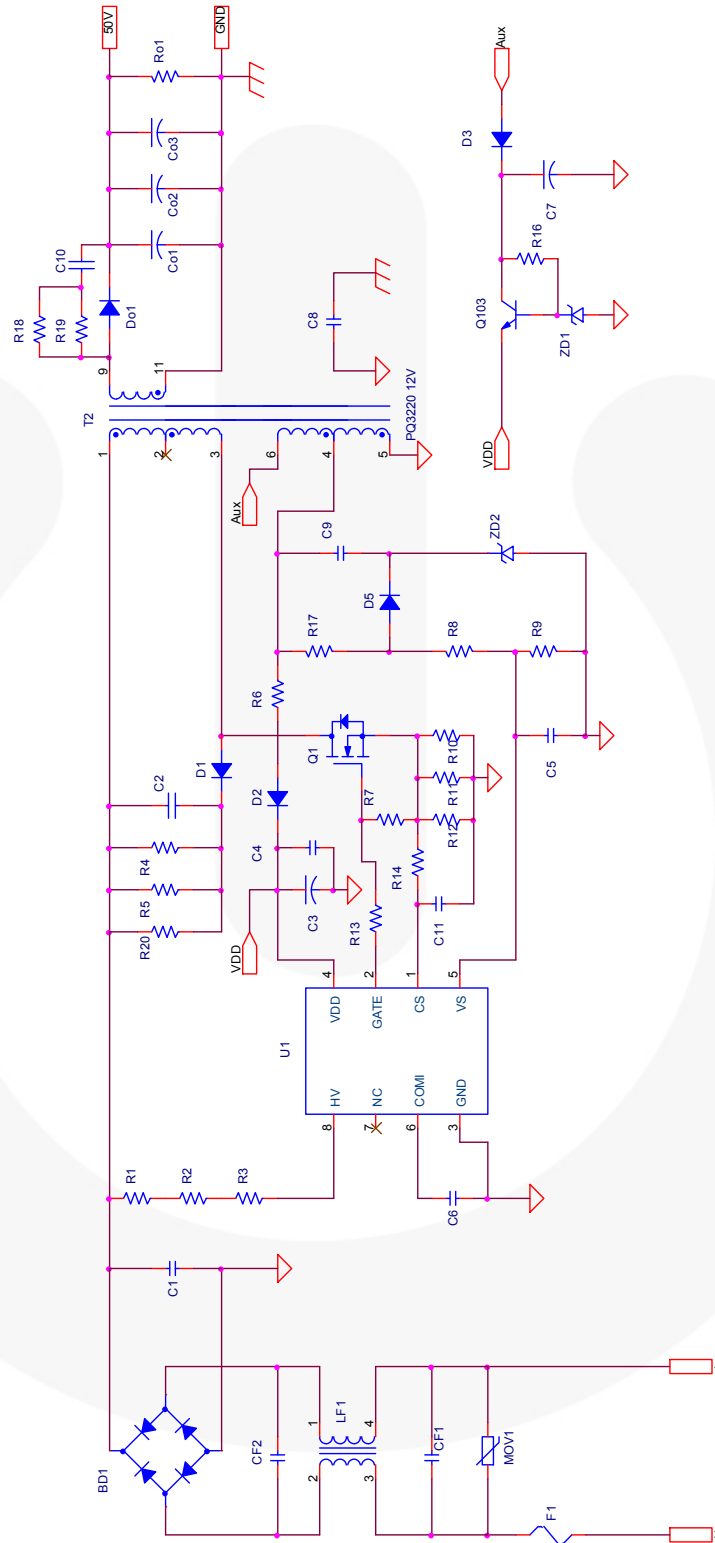

Figure 7. Schematic





## 6. Evaluation Board Bill of Materials

Item No.	Part Reference	Part Number	Qty.	Description	Manufacturer
1	BD1	G3SBA60	1	4 A / 600 V, Bridge Diode	Vishay
2	CF1	MPX AC275 V 474K	1	470 nF / 275 V <sub>AC</sub> , X-Capacitor	Carli
3	CF2	MPX AC275 V 224K	1	220 nF / 275 V <sub>AC</sub> , X-Capacitor	Carli
4	Co1, Co2, Co3	KMG 470 $\mu$ F / 63 V	3	470 $\mu$ F / 63 V, Electrolytic Capacitor	Samyoung
5	C1	MPE 630 V 334K	1	330 nF / 630 V, MPE film Capacitor	Sungho
6	C2	C1206C103KDRACTU	1	10 nF / 630 V, SMD Capacitor 1206	Kemet
7	C3	KMG 10 $\mu$ F / 35 V	1	10 $\mu$ F / 35 V, Electrolytic Capacitor	Samyoung
8	C4	C0805C104K5RACTU	1	100 nF / 50 V, SMD Capacitor 2012	Kemet
9	C5	C0805C519C3GACTU	1	5.1 pF / 25 V, SMD Capacitor 2012	Kemet
10	C6	C0805C225K4RACTU	1	2.2 $\mu$ F / 16 V, SMD Capacitor 2012	Kemet
11	C7	KMG 1 $\mu$ F / 100 V	1	1 $\mu$ F / 100 V, Electrolytic Capacitor	Samyoung
12	C8	SCFz2E472M10BW	1	4.7 nF / 250 V, Y-Capacitor	Samwha
13	C9	C1206C331KCRACTU	1	330 pF / 500 V, SMD Capacitor 1206	Kemet
14	C10	C1206C221KCRACTU	1	220 pF / 500 V, SMD Capacitor 0805	Kemet
15	C11	C0805C101C3GACTU	1	100 pF / 25 V, SMD Capacitor 0805	Kemet
16	Do1	FFPF08H60S	1	600 V / 8 A, Hyperfast Rectifier	Fairchild Semiconductor
17	D1, D3	RS1M	2	1000 V / 1 A, Ultra-Fast Recovery Diode	Fairchild Semiconductor
18	D2	1N4003	1	200 V / 1 A, General Purpose Rectifier	Fairchild Semiconductor
19	D5	LL4148	1	100 V / 0.2 A, Small Signal Diode	Fairchild Semiconductor
20	F1	250 V / 2 A	1	250 V / 2 A, Fuse	Bussmann
21	LF1	B82733F	1	40 mH Common Inductor	EPCOS
22	MOV1	SVC471D-10A	1	Metal Oxide Varistor	Samwha
23	Q1	FCPF400N80Z	1	800 V / 400 m $\Omega$ , N-Channel MOSFET	Fairchild Semiconductor
24	Q103	KSP42	1	High Voltage Transistor	Fairchild Semiconductor
25	Ro1	RC1206JR-0727KL	1	27 k $\Omega$ , SMD Resistor 1206	Yageo
26	R1, R7	RC1206JR-0710KL	2	10 k $\Omega$ , SMD Resistor 1206	Yageo
27	R2, R3	RC1206JR-0715KL	2	15 k $\Omega$ , SMD Resistor 1206	Yageo
28	R4, R5, R20	RC1206JR-07100KL	3	100 k $\Omega$ , SMD Resistor 1206	Yageo
29	R6	RC1206JR-0710RL	1	10 $\Omega$ , SMD Resistor 1206	Yageo
30	R8	RC0805JR-07160KL	1	160 k $\Omega$ , SMD Resistor 0805	Yageo
31	R9	RC0805JR-0751KL	1	51 k $\Omega$ , SMD Resistor 0805	Yageo
32	R10	RC1206JR-070R2L	1	0.2 $\Omega$ , SMD Resistor 1206	Yageo
33	R11, R12	RC1206JR-073RL	2	3 $\Omega$ , SMD Resistor 1206	Yageo
34	R13	RC0805JR-0710RL	1	10 $\Omega$ , SMD Resistor 0805	Yageo
35	R14	RC0805JR-07510RL	1	510 $\Omega$ , SMD Resistor 0805	Yageo



Item No.	Part Reference	Part Number	Qty.	Description	Manufacturer
36	R16	RC1206JR-0730KL	1	30 k $\Omega$ , SMD Resistor 1206	Yageo
37	R17	RC1206JR-071K2L	1	1.2 k $\Omega$ , SMD Resistor 1206	Yageo
38	R18, R19	RC1206JR-0730RL	2	30 $\Omega$ , SMD Resistor 1206	Yageo
39	T1	PQ3220	1	PQ Core, 12-Pin Transformer	TDK
40	U1	FL7733A	1	Main PSR Controller	Fairchild Semiconductor
41	ZD1	MM5Z15V	1	15 V Zener Diode	Fairchild Semiconductor
42	ZD2	MM5Z10V	1	10 V Zener Diode	Fairchild Semiconductor

## 7. Transformer Design

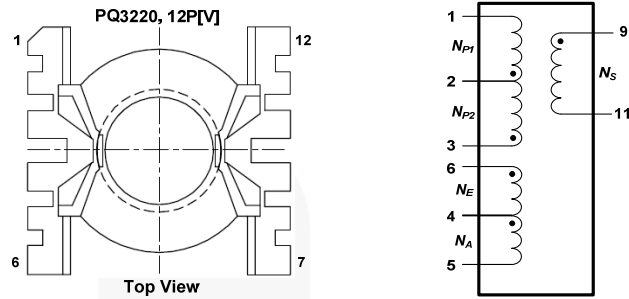

Figure 8. Transformer PQ3220's Bobbin Structure and Pin Configuration

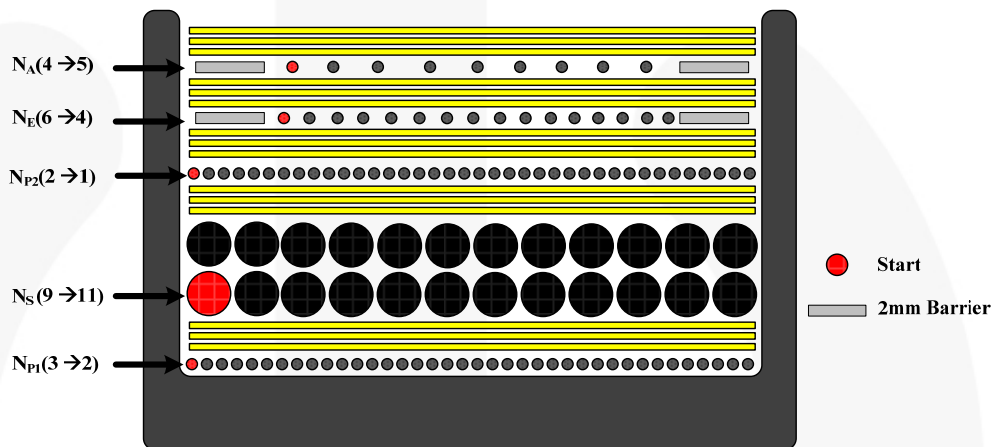

Figure 9. Transformer Winding Structure

Table 2. Winding Specifications

No	Winding	Pin(S → F)	Wire	Turns	Winding Method
1	$N_{P1}$	3 → 2	0.45 $\phi$	17 Ts	Solenoid Winding
2	Insulation: Polyester Tape t = 0.025 mm, 3-Layer				
3	$N_S$	9 → 11	0.7 $\phi$ (TIW)	19 Ts	Solenoid Winding
4	Insulation: Polyester Tape t = 0.025 mm, 3-Layer				
5	$N_{P1}$	2 → 1	0.45 $\phi$	11 Ts	Solenoid Winding
	Insulation: Polyester Tape t = 0.025 mm, 3-Layer				
6	$N_E$	6 → 4	0.25 $\phi$	16 Ts	Solenoid Winding
7	Insulation: Polyester Tape t = 0.025 mm, 3-Layer				
8	$N_A$	4 → 5	0.25 $\phi$	8 Ts	Solenoid Winding
9	Insulation: Polyester Tape t = 0.025 mm, 3-Layer				

Table 3. Electrical Characteristics

	Pin	Specifications	Remark
Inductance	1 – 3	160 $\mu$ H $\pm$ 10%	60 kHz, 1 V
Leakage	1 – 3	5 $\mu$ H	60 kHz, 1 V, Short All Output Pins

## 8. Evaluation Board Performance

**Table 4. Test Condition & Equipment List**

Ambient Temperature	$T_A = 25\text{ }^\circ\text{C}$
Test Equipment	AC Power Source: PCR500L by Kikusui Power Analyzer: PZ4000000 by Yokogawa Electronic Load: PLZ303WH by KIKUSUI Multi Meter: 2002 by KEITHLEY, 45 by FLUKE Oscilloscope: 104Xi by LeCroy Thermometer: Thermal CAM SC640 by FLIR SYSTEMS LED: EHP-AX08EL/GT01H-P03 (3W) by Everlight

## 8.1. Startup

Figure 10 and Figure 11 show the overall startup performance at rated output load. The output load current starts flowing after about 0.2 s and 0.1 s for input voltage 90 V<sub>AC</sub> and 277 V<sub>AC</sub> condition upon AC input power switch turns on; CH1: V<sub>DD</sub> (10 V / div), CH2: V<sub>IN</sub> (100 V / div), CH3: V<sub>LED</sub> (20 V / div), CH4: I<sub>LED</sub> (500 A / div), Time Scale: (100 ms / div), Load: 2 parallel \* 18 series-LEDs.

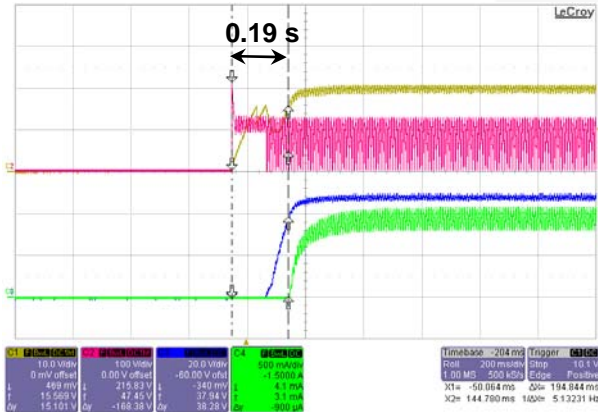

Figure 10. V<sub>IN</sub> = 90 V<sub>AC</sub> / 60 Hz

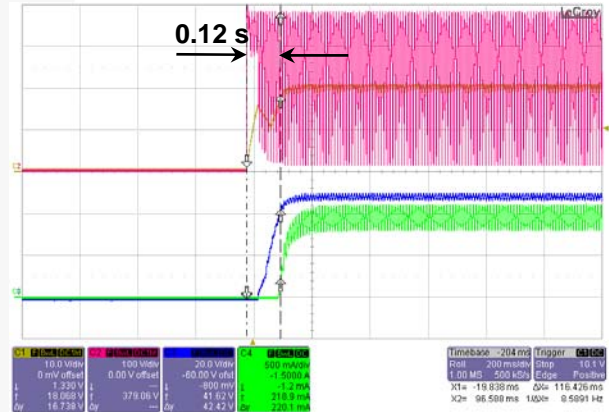

Figure 11. V<sub>IN</sub> = 277 V<sub>AC</sub> / 50 Hz

## 8.2. Operation Waveforms

Figure 12 to Figure 15 show AC input and output waveforms at rated output load.  
 CH1:  $I_{IN}$  (1.00 A / div), CH2:  $V_{IN}$  (100 V / div), CH3:  $V_{LED}$  (20 V / div), CH4:  $I_{LED}$  (500 mA / div), Time Scale: (5 ms / div), Load: 2 parallel \* 18 series-LEDs.

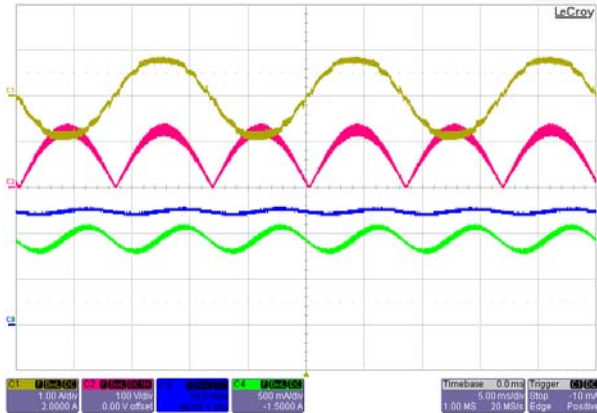

Figure 12.  $V_{IN} = 90 V_{AC} / 60 \text{ Hz}$

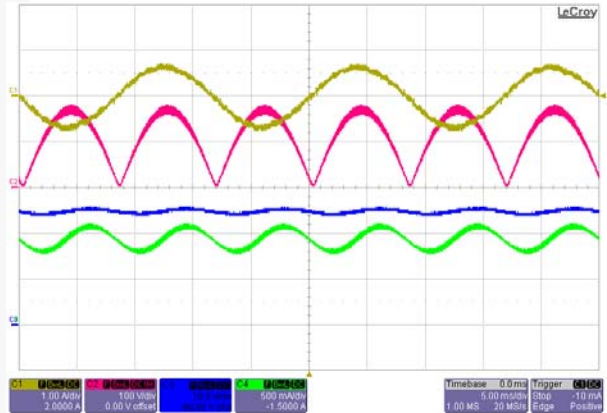

Figure 13.  $V_{IN} = 120 V_{AC} / 60 \text{ Hz}$

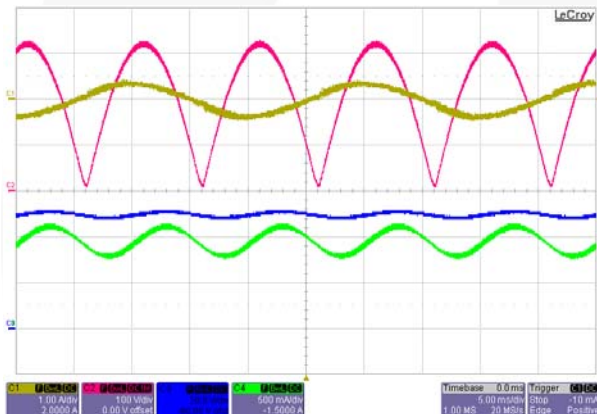

Figure 14.  $V_{IN} = 230 V_{AC} / 50 \text{ Hz}$

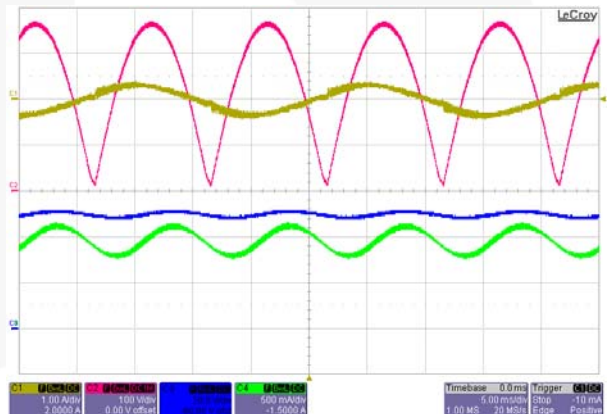

Figure 15.  $V_{IN} = 277 V_{AC} / 50 \text{ Hz}$

Figure 16 to Figure 19 show key waveforms of single-stage flyback converter operation for line voltage at rated output load. CH1:  $I_{DS}$  (2.00 A / div), CH2:  $V_{DS}$  (200 V / div), CH3:  $V_{SEC-Diode}$  (200 V / div), CH4:  $I_{SEC-Diode}$  (5.00 A / div), Load: 2 parallel \* 18 series-LEDs.

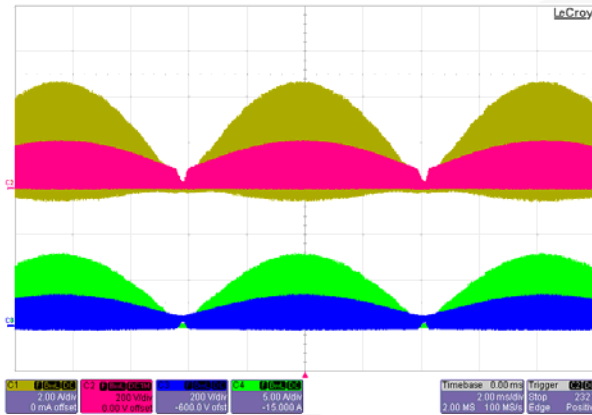

Figure 16.  $V_{IN} = 90 V_{AC} / 60 \text{ Hz}$ , [2.0 ms / div]

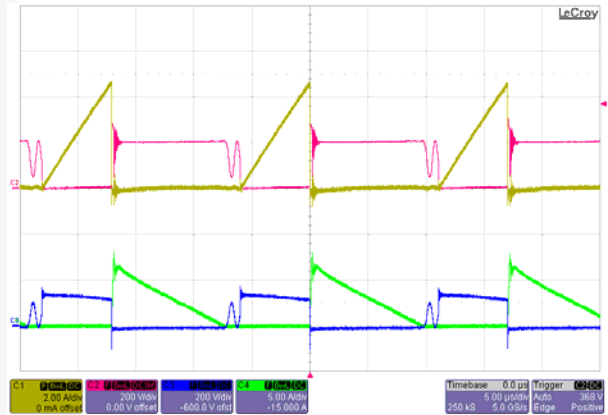

Figure 17.  $V_{IN} = 90 V_{AC} / 60 \text{ Hz}$ , [5.0  $\mu\text{s}$  / div]

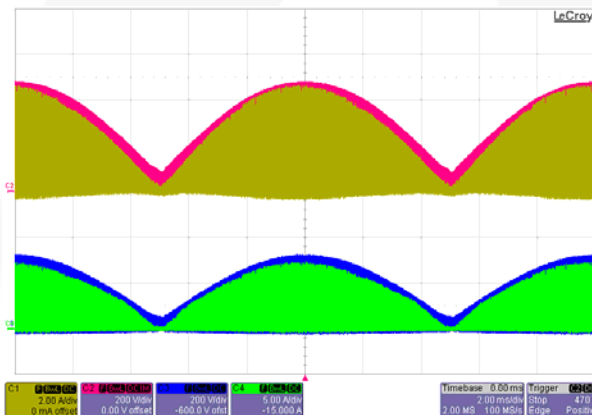

Figure 18.  $V_{IN} = 277 V_{AC} / 60 \text{ Hz}$ , [2.0 ms / div]

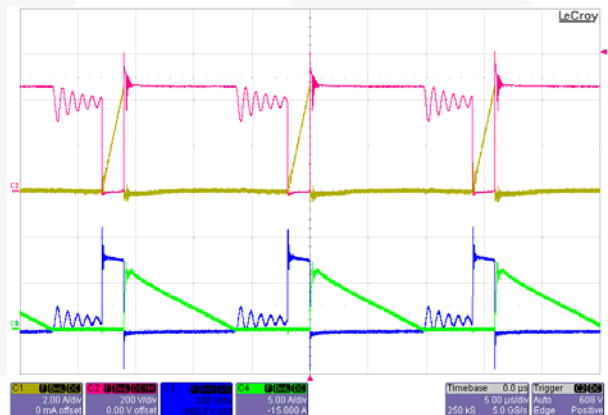

Figure 19.  $V_{IN} = 277 V_{AC} / 60 \text{ Hz}$ , [5.0  $\mu\text{s}$  / div]

### 8.3. Constant-Current Regulation

The output current deviation for wide output voltage ranges from 7 V to 55 V is less than  $\pm 1.75\%$  at each line voltage. Line regulation at the output voltage (52 V) is also less than  $\pm 0.85\%$ . The results were measured with E-load [CR Mode].

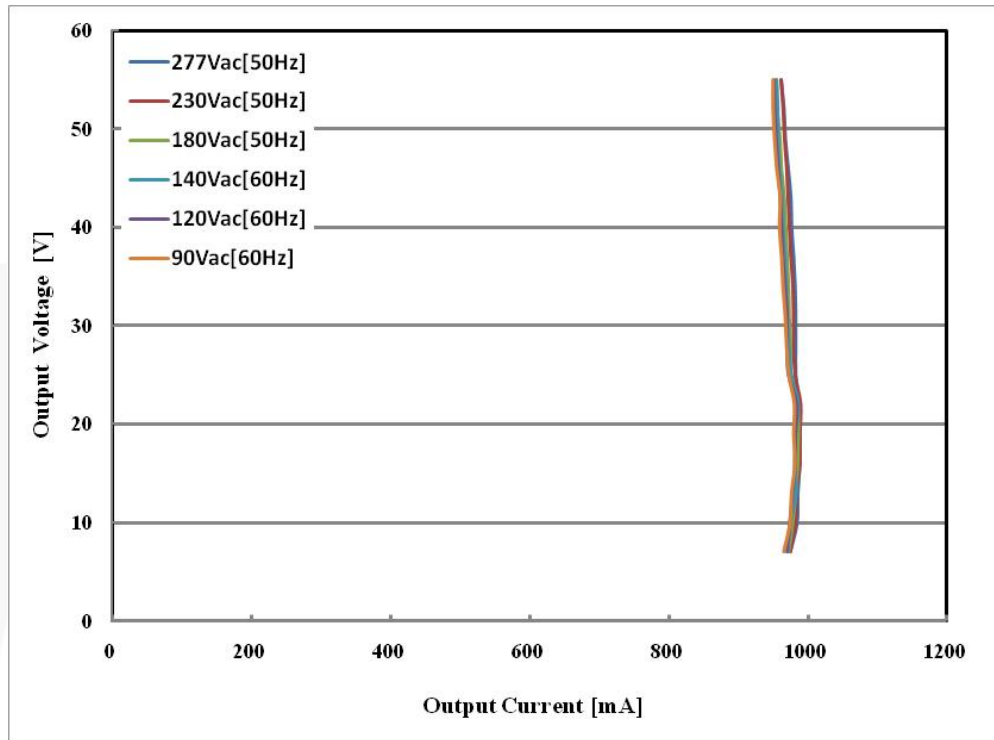

Figure 20. Constant-Current Regulation

Table 5. Constant-Current Regulation by Output Voltage Change (7 ~ 55 V)

Input Voltage	Min. Current [mA]	Max. Current [mA]	Tolerance
90 V <sub>AC</sub> [60 Hz]	950	981	$\pm 1.61\%$
120 V <sub>AC</sub> [60 Hz]	951	984	$\pm 1.71\%$
140 V <sub>AC</sub> [60 Hz]	955	986	$\pm 1.60\%$
180 V <sub>AC</sub> [50 Hz]	955	986	$\pm 1.60\%$
230 V <sub>AC</sub> [50 Hz]	961	989	$\pm 1.44\%$
277 V <sub>AC</sub> [50 Hz]	961	988	$\pm 1.39\%$

Table 6. Constant-Current Regulation by Line Voltage Change (90~277 V<sub>AC</sub>)

Output Voltage	90 V <sub>AC</sub> [60 Hz]	120 V <sub>AC</sub> [60 Hz]	140 V <sub>AC</sub> [60 Hz]	180 V <sub>AC</sub> [50 Hz]	230 V <sub>AC</sub> [50 Hz]	277 V <sub>AC</sub> [50 Hz]	Tolerance
55 V	950 mA	951 mA	957 mA	955 mA	961 mA	961 mA	$\pm 0.58\%$
52 V	950 mA	952 mA	957 mA	956 mA	964 mA	965 mA	$\pm 0.78\%$
46 V	955 mA	957 mA	963 mA	962 mA	969 mA	971 mA	$\pm 0.83\%$



## V<sub>S</sub> Circuits for Wide Output

The first consideration for R1, R2, and R3 selection is to set V<sub>S</sub> to 2.45 V to ensure high-frequency operation at the rated output power.

The second consideration is V<sub>S</sub> blanking. The output voltage is detected by auxiliary winding and a resistive divider connected to the VS pin, as shown in Figure 21. However, in a single-stage flyback converter without a DC link capacitor, auxiliary winding voltage cannot be clamped to reflected output voltage at low line voltage due to the small L<sub>m</sub> current, which induces V<sub>S</sub> voltage-sensing error. Frequency decreases rapidly at the zero-crossing point of line voltage, which can cause LED light flicker. To maintain constant frequency over the whole sinusoidal line voltage, V<sub>S</sub> blanking disables V<sub>S</sub> sampling at less than a particular line voltage V<sub>IN,blnk</sub> by sensing the auxiliary winding.

The third consideration is V<sub>S</sub> level, which should be operated between 0.6 V and 3 V to avoid triggering SLP and V<sub>S</sub> OVP in wide output application. V<sub>S</sub> level can be maintained using additional V<sub>S</sub> circuits, as shown in Figure 21.

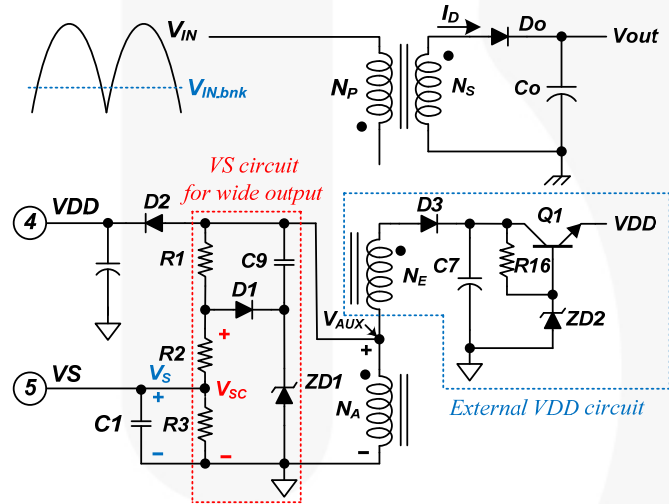

**Figure 21. External Circuitry for System Operation in Wide Output Voltage Ranges**

Considering the maximum switching frequency up to 50% of maximum output voltage, Zener diode and R1, R2, and R3 are obtained as:

$$V_{ZD1} < (V_{DD,OVP} \times 0.5) - V_{F,D1} \quad (1)$$

where V<sub>F,D1</sub> is the forward voltage of D1 connected in series with Zener diode ZD1.

Considering Zener diode voltage regulation and its power rating, R1 can be selected to limit the Zener diode current I<sub>ZD1</sub> to 10 mA maximum, such as:

$$R1 = \frac{(V_{DD,OVP} - V_{SC})}{10mA} = 1.2 \text{ k}\Omega \quad (2)$$

where V<sub>SC</sub> is voltage clamped by D1 and ZD1.

$$R2 = n_{AP} \times \frac{V_{IN,blnk}}{I_{VS,blnk}} - R1 \quad (3)$$

where V<sub>IN,blnk</sub> and I<sub>VS,blnk</sub> line voltage level and V<sub>S</sub> current for V<sub>S</sub> blanking, respectively.

$$R3 \geq \frac{R2 \times 2.45}{V_{SC} - 2.45} \quad (4)$$

Additional consideration in  $V_S$  circuits for wide output voltage range is  $t_{DIS}$  delay, which is caused by the voltage difference when the  $V_{AUX}$  across auxiliary winding is clamped to  $V_{SC}$ , as shown in Figure 22. This delay lasts until  $V_{AUX}$  is at the same level as  $V_{SC}$  and may affect constant output current regulation. It can be removed by capacitor C9 connected between auxiliary winding and cathode terminal of Zener diode ZD1. The  $V_{AUX}$  is divided into capacitor voltage  $V_{C3}$  and  $V_{ZD1}$  after the MOSFET gate is turned off. Then  $V_{C3}$  maintains its voltage without discharging while  $V_{ZD2}$  slowly decreases to  $V_{AUX} - V_{C3}$  as the output diode current  $I_D$  reaches zero. Therefore,  $V_S$  can follow  $V_{AUX}$ , as shown by the dotted line in Figure 22. C3 should be selected to the proper value depending on resonant frequency determined by the resonance between magnetizing inductance  $L_m$  and MOSFET's  $C_{OSS}$ . The 330 pF used in this application was selected by trial and error. Its value can be obtained as:

$$C9 = \frac{300 \text{ kHz}}{f_r} \cdot 330 \text{ pF} \quad (5)$$

where  $f_r$  is the resonance frequency determined by the resonance between  $C_{OSS}$  and  $L_m$ .

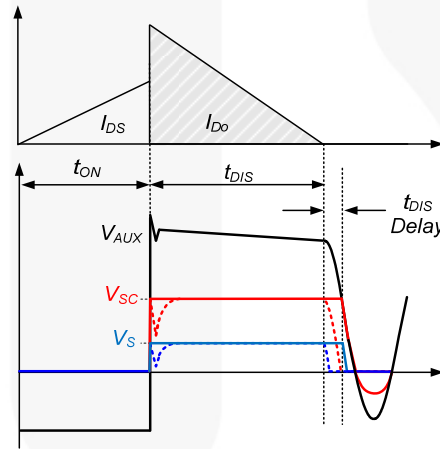

Figure 22. Waveforms in  $V_S$  Circuits

#### $V_{DD}$ Circuit for Wide Output

FL7733A's  $V_{DD}$  operation range is 8.75 ~ 23 V and UVLO is triggered and shuts down switching if output voltage is lower than  $V_{OUT} - V_{UVLO}$  ( $8.75 \times N_S / N_A$ ). Therefore,  $V_{DD}$  should be supplied properly without triggering UVLO across the wide output voltage range of 7 ~ 55 V.  $V_{DD}$  can be supplied by adding external winding  $N_E$  and  $V_{DD}$  circuits composed of voltage regulator, as shown in Figure 21. The  $N_E$  should be designed so  $V_{DD}$  can be supplied without triggering UVLO at minimum output voltage ( $V_{min.OUT}$ ). Therefore, the external winding  $N_E$  can be determined as follows:

$$N_E > \frac{(8.75 + V_{CE,Q1} + V_{F,D3})}{(V_{F,D0} + V_{min.OUT})} \times N_S - N_A \quad (6)$$

where  $V_{CE,Q1}$  is Q1's collector-emitter saturation voltage,  $V_{F,D3}$  is D3's forward voltage, and  $V_{F,D0}$  is forward voltage of the output diode at minimum output voltage.

### 8.4. Short- / Open-LED Protections

Figure 23 to Figure 26 show the operating waveforms when the LED short protection is triggered and recovered. Once the LED short occurs, SCP is triggered and  $V_{DD}$  starts “Hiccup” Mode with JFET regulation times [250 ms]. This lasts until the fault condition is removed. Systems can restart automatically when the output load returns to normal condition. CH1:  $V_{DD}$  (10 V / div), CH2:  $V_{IN}$  (200 V / div), CH3:  $V_{GATE}$  (10 V / div),  $I_{OUT}$  (500 mA / div), Time Scale: (500 ms / div).

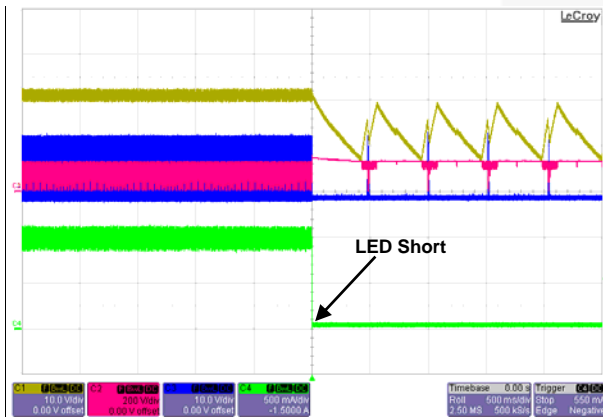

Figure 23.  $V_{IN} = 90 V_{AC} / 60 \text{ Hz}$ , [LED Short]

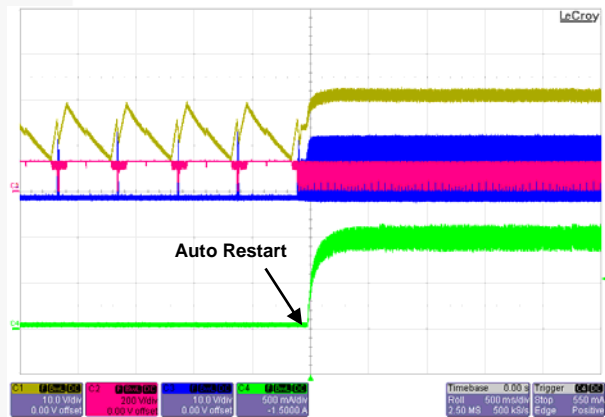

Figure 24.  $V_{IN} = 120 V_{AC} / 60 \text{ Hz}$ , [LED Restore]

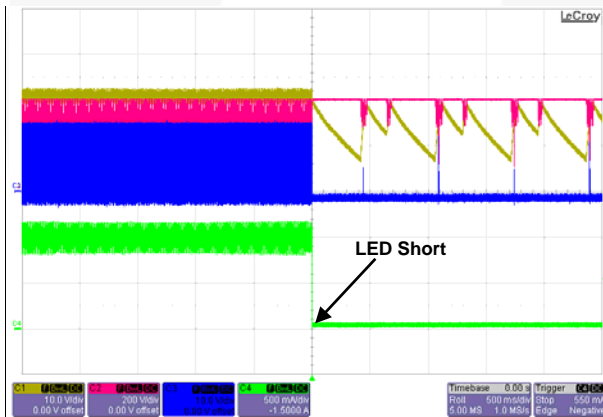

Figure 25.  $V_{IN} = 277 V_{AC} / 50 \text{ Hz}$ , [LED Short]

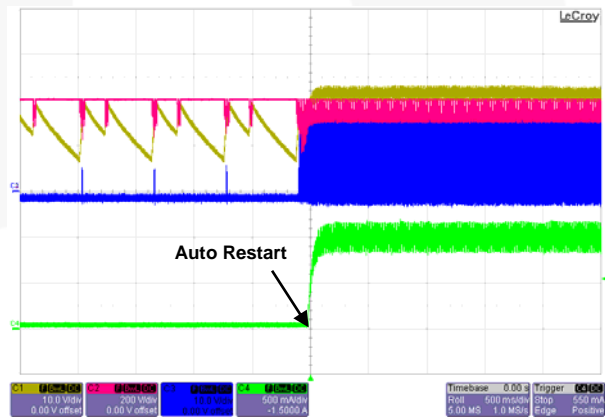

Figure 26.  $V_{IN} = 277 V_{AC} / 50 \text{ Hz}$ , [LED Restore]

Figure 27 to Figure 30 show the operating waveforms when the LED open condition is triggered and recovered. Once the output goes open circuit,  $V_S$  OVP or  $V_{DD}$  OVP are triggered and  $V_{DD}$  starts Hiccup Mode with JFET regulation times [250 ms]. This lasts until the fault condition is eliminated. Systems can restart automatically when returned to normal condition. CH1:  $V_{DD}$  (10 V / div), CH2:  $V_{IN}$  (200 V / div), CH3:  $V_{GATE}$  (10 V / div),  $V_{OUT}$  (50 V / div), Time Scale: (500 ms / div).

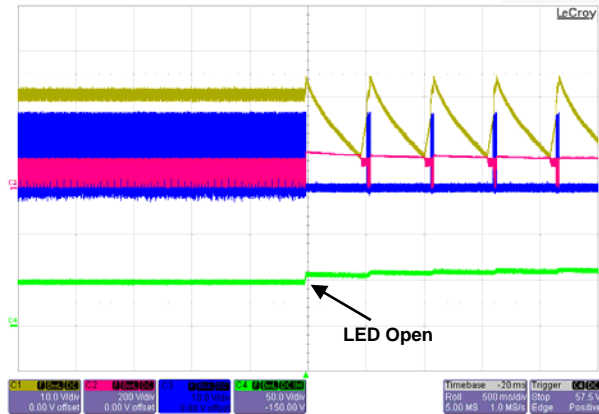

Figure 27.  $V_{IN} = 90 V_{AC} / 60 Hz$ , [LED Short]

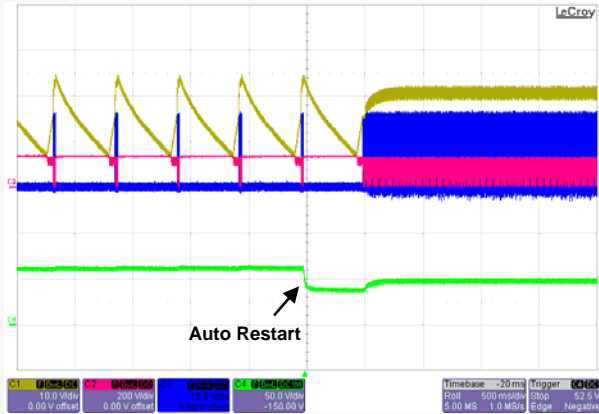

Figure 28.  $V_{IN} = 90 V_{AC} / 60 Hz$ , [LED Restore]

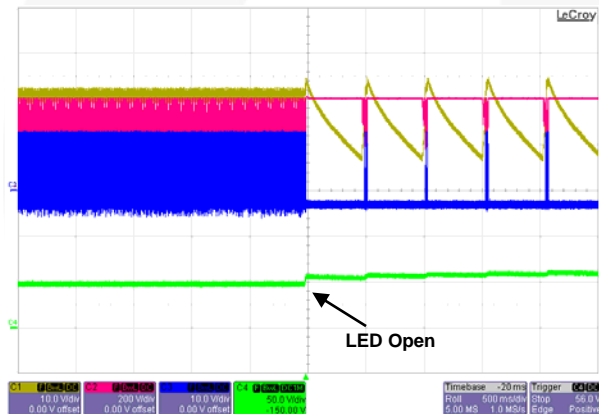

Figure 29.  $V_{IN} = 277 V_{AC} / 50 Hz$ , [LED Short]

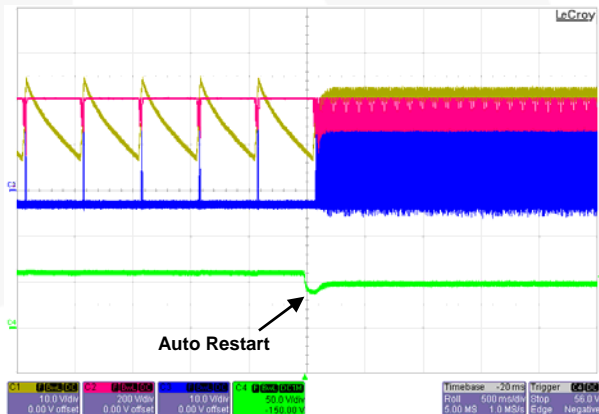

Figure 30.  $V_{IN} = 277 V_{AC} / 50 Hz$ , [LED Restore]

**Note:**

1. When the LED load is re-connected after open-LED condition, the output capacitor is quickly discharged through the LED load and the inrush current by the discharge could destroy the LED load.

## 8.5. Efficiency

System efficiency is 87.56% ~ 90.81% over input voltages 90 ~ 277 V<sub>AC</sub>. The results were measured using actual rated LED loads 30 minutes after startup.

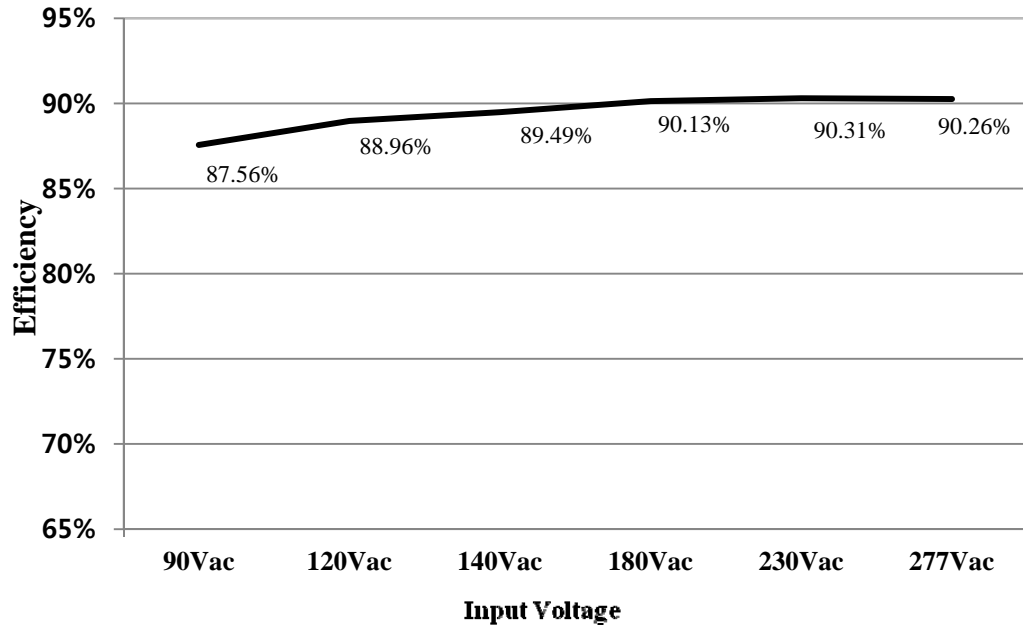

Figure 31. System Efficiency

Table 7. System Efficiency

Input Voltage	Input Power (W)	Output Current (A)	Output Voltage (V)	Output Power (W)	Efficiency (%)
90 V <sub>AC</sub> [60 Hz]	53.68	0.952	49.40	47.00	87.56
120 V <sub>AC</sub> [60 Hz]	53.18	0.955	49.52	47.31	88.96
140 V <sub>AC</sub> [60 Hz]	53.05	0.958	49.57	47.47	89.49
180 V <sub>AC</sub> [50 Hz]	54.43	0.963	50.95	49.06	90.13
230 V <sub>AC</sub> [50 Hz]	54.66	0.969	50.94	49.36	90.31
277 V <sub>AC</sub> [50 Hz]	54.78	0.974	50.78	49.44	90.26

### 8.6. Power Factor (PF) & Total Harmonic Distortion (THD)

The FL7733A evaluation board shows excellent THD performance: much less than 10%. The results were measured using actual rated LED loads 10 minutes after startup.

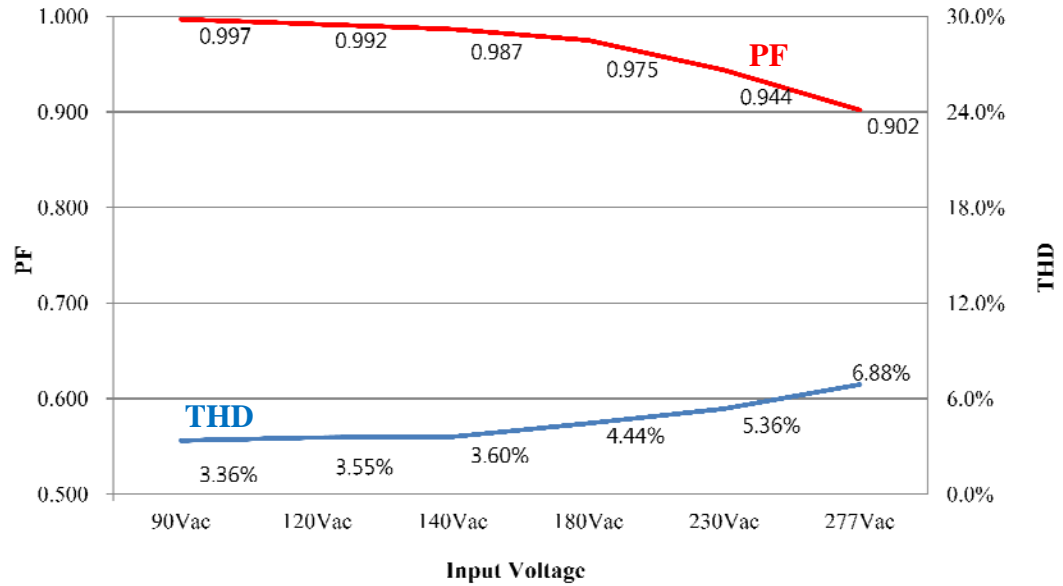

Figure 32. Power Factor & Total Harmonic Distortion

Table 8. Power Factor & Total Harmonic Distortion

Input Voltage	Output Current (A)	Output Voltage (V)	Power Factor	THD (%)
90 V <sub>AC</sub> [60 Hz]	0.952	49.40	0.997	3.36
120 V <sub>AC</sub> [60 Hz]	0.955	49.52	0.992	3.55
140 V <sub>AC</sub> [60 Hz]	0.958	49.57	0.987	3.60
180 V <sub>AC</sub> [50 Hz]	0.963	50.95	0.975	4.44
230 V <sub>AC</sub> [50 Hz]	0.969	50.94	0.944	5.36
277 V <sub>AC</sub> [50 Hz]	0.974	50.78	0.902	6.88

## 8.7. Harmonics

Figure 33 to Figure 36 show current harmonics measured using actual rated LED loads.

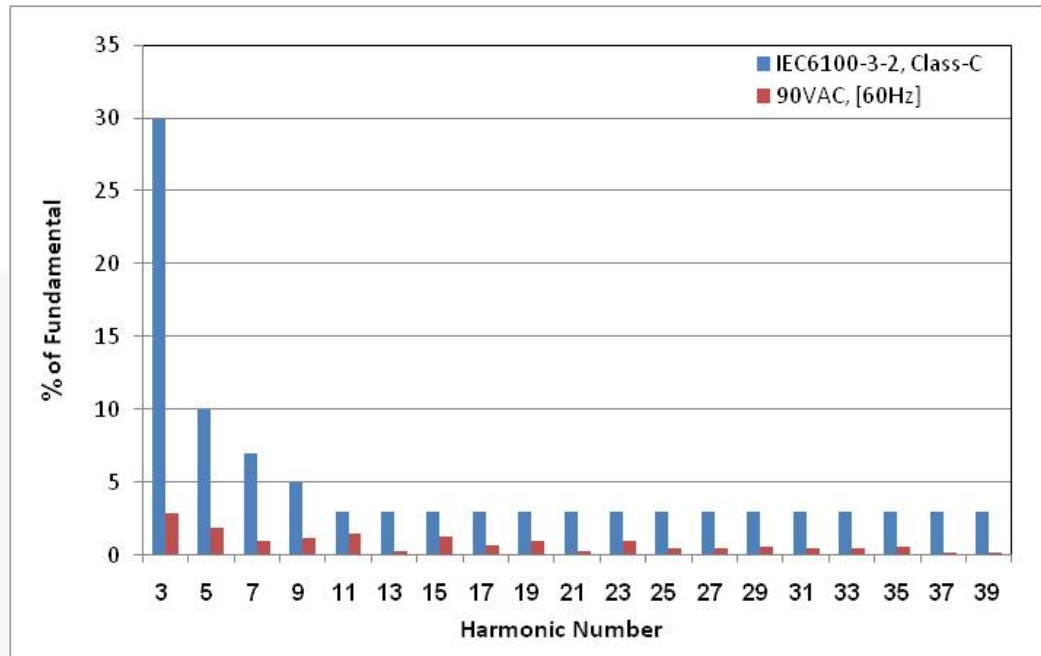

Figure 33.  $V_{IN} = 90 V_{AC} / 60 Hz$

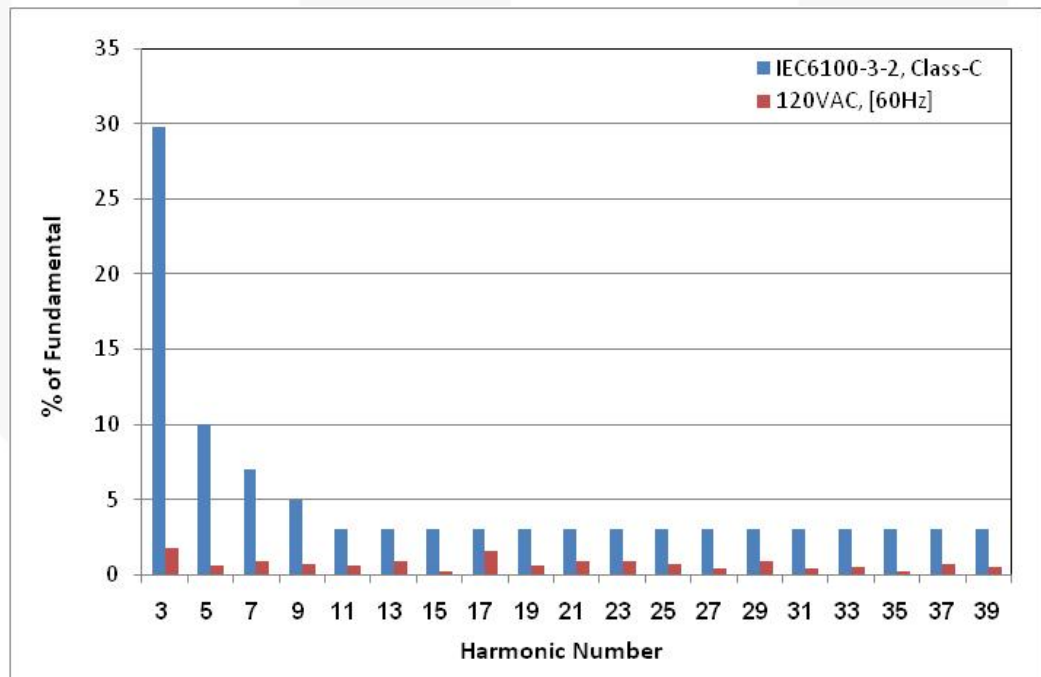

Figure 34.  $V_{IN} = 120 V_{AC} / 60 Hz$

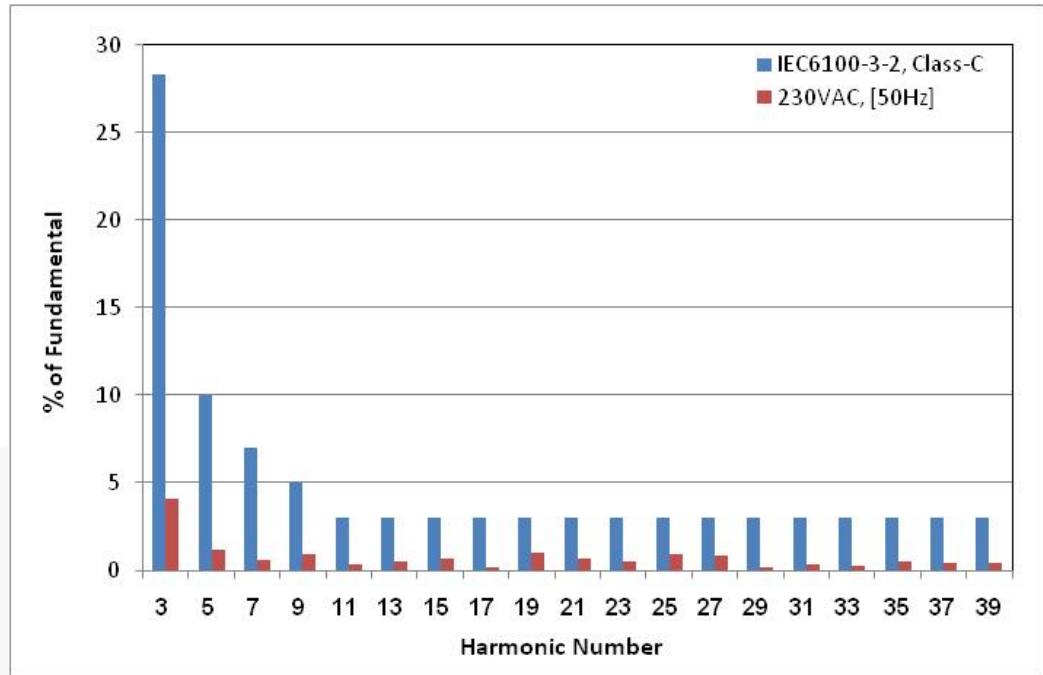

Figure 35.  $V_{IN} = 230 V_{AC} / 50 \text{ Hz}$

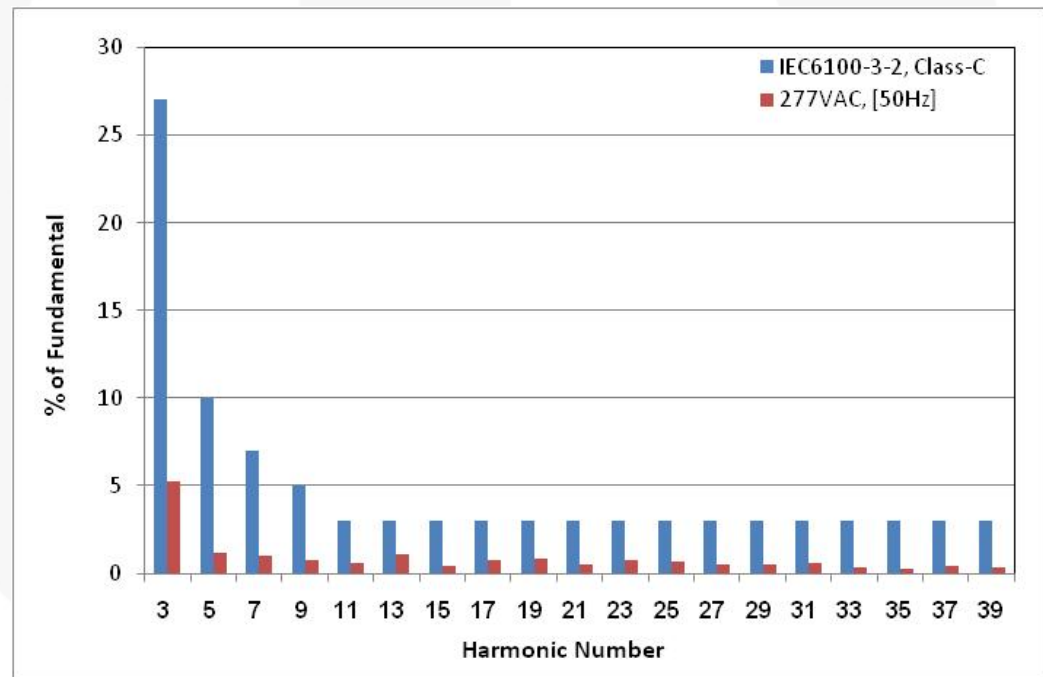

Figure 36.  $V_{IN} = 277 V_{AC} / 50 \text{ Hz}$



## 8.8. Operating Temperature

Temperatures on all components for this board are less than 68°C.

The results were measured using actual rated LED loads 60 minutes after startup.

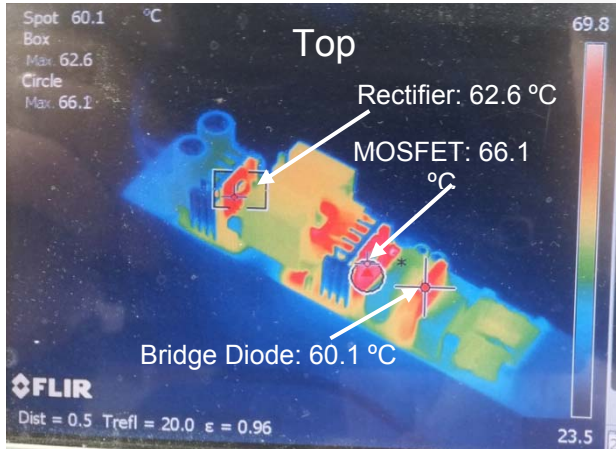

Figure 37.  $V_{IN} = 90 V_{AC} / 60 \text{ Hz}$

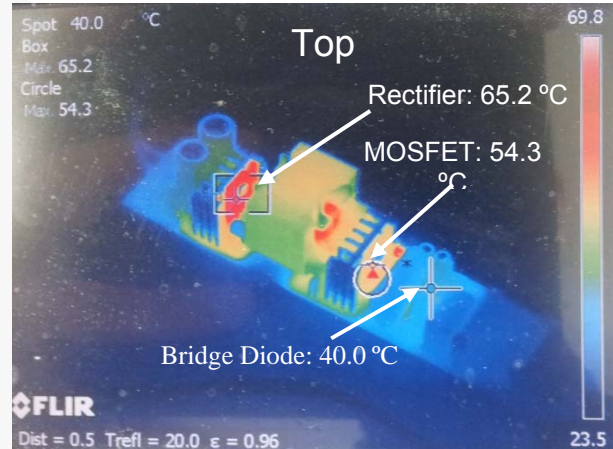

Figure 38.  $V_{IN} = 277 V_{AC} / 50 \text{ Hz}$

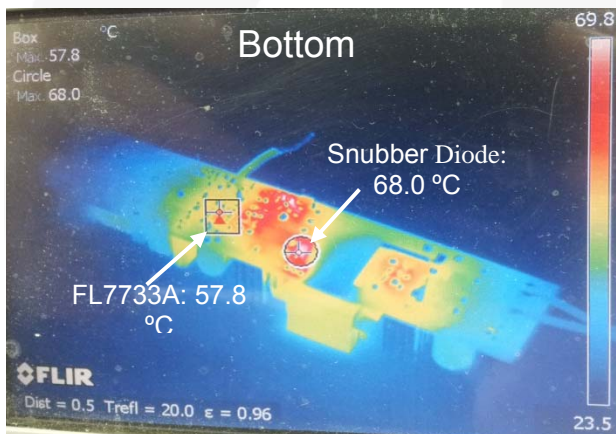

Figure 39.  $V_{IN} = 90 V_{AC} / 60 \text{ Hz}$

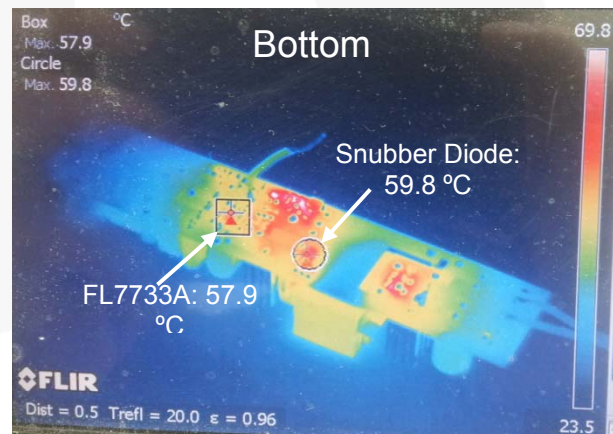

Figure 40.  $V_{IN} = 277 V_{AC} / 50 \text{ Hz}$

**Note:**

- The IC temperature can be improved by the PCB layout.

### 8.9. Electromagnetic Interference (EMI)

All measurements were conducted in observance of EN55022 criteria.

The results were measured using actual rated LED loads 30 minutes after startup.

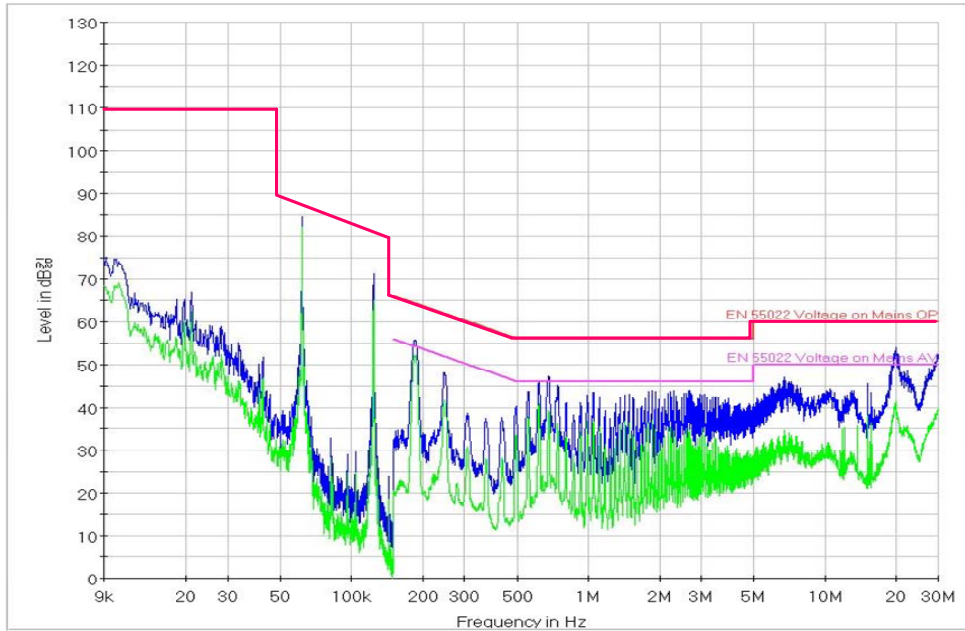

**Figure 41.  $V_{IN}$  [220 V<sub>AC</sub>, Neutral]**

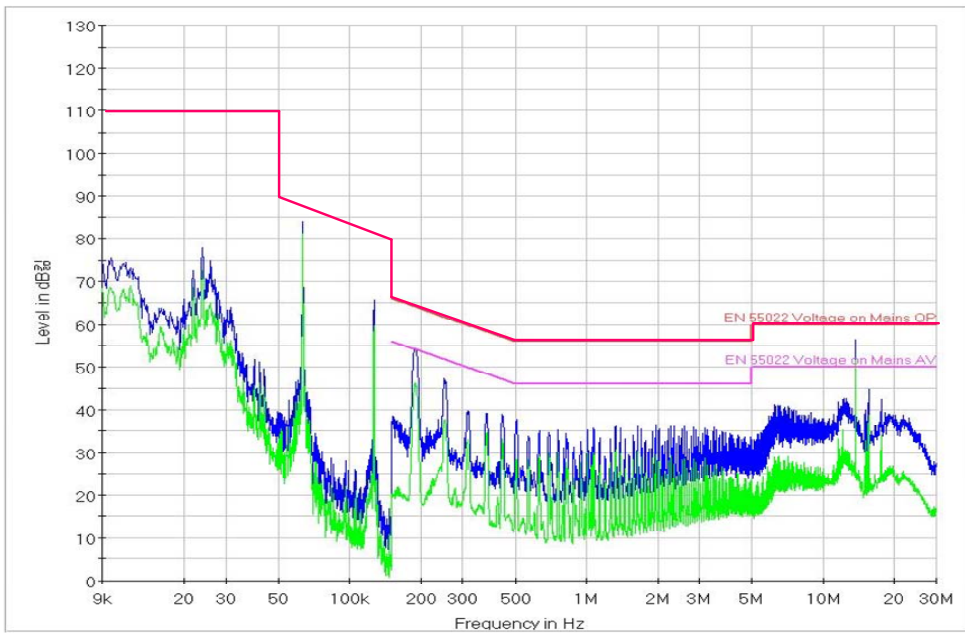

**Figure 42.  $V_{IN}$  [110 V<sub>AC</sub>, Live]**



## 9. Revision History

Rev.	Date	Description
1.0	Sep. 2014	Initial Release

### WARNING AND DISCLAIMER

Replace components on the Evaluation Board only with those parts shown on the parts list (or Bill of Materials) in the Users' Guide. Contact an authorized Fairchild representative with any questions.

The Evaluation board (or kit) is for demonstration purposes only and neither the Board nor this User's Guide constitute a sales contract or create any kind of warranty, whether express or implied, as to the applications or products involved. Fairchild warrants that its products meet Fairchild's published specifications, but does not guarantee that its products work in any specific application. Fairchild reserves the right to make changes without notice to any products described herein to improve reliability, function, or design. Either the applicable sales contract signed by Fairchild and Buyer or, if no contract exists, Fairchild's standard Terms and Conditions on the back of Fairchild invoices, govern the terms of sale of the products described herein.

#### DISCLAIMER

FAIRCHILD SEMICONDUCTOR RESERVES THE RIGHT TO MAKE CHANGES WITHOUT FURTHER NOTICE TO ANY PRODUCTS HEREIN TO IMPROVE RELIABILITY, FUNCTION, OR DESIGN. FAIRCHILD DOES NOT ASSUME ANY LIABILITY ARISING OUT OF THE APPLICATION OR USE OF ANY PRODUCT OR CIRCUIT DESCRIBED HEREIN; NEITHER DOES IT CONVEY ANY LICENSE UNDER ITS PATENT RIGHTS, NOR THE RIGHTS OF OTHERS.

#### LIFE SUPPORT POLICY

FAIRCHILD'S PRODUCTS ARE NOT AUTHORIZED FOR USE AS CRITICAL COMPONENTS IN LIFE SUPPORT DEVICES OR SYSTEMS WITHOUT THE EXPRESS WRITTEN APPROVAL OF THE PRESIDENT OF FAIRCHILD SEMICONDUCTOR CORPORATION.

As used herein:

1. Life support devices or systems are devices or systems which, (a) are intended for surgical implant into the body, or (b) support or sustain life, or (c) whose failure to perform when properly used in accordance with instructions for use provided in the labeling, can be reasonably expected to result in significant injury to the user.
2. A critical component is any component of a life support device or system whose failure to perform can be reasonably expected to cause the failure of the life support device or system, or to affect its safety or effectiveness.

### ANTI-COUNTERFEITING POLICY

Fairchild Semiconductor Corporation's Anti-Counterfeiting Policy. Fairchild's Anti-Counterfeiting Policy is also stated on our external website, [www.fairchildsemi.com](http://www.fairchildsemi.com), under Sales Support.

Counterfeiting of semiconductor parts is a growing problem in the industry. All manufacturers of semiconductor products are experiencing counterfeiting of their parts. Customers who inadvertently purchase counterfeit parts experience many problems such as loss of brand reputation, substandard performance, failed applications, and increased cost of production and manufacturing delays. Fairchild is taking strong measures to protect ourselves and our customers from the proliferation of counterfeit parts. Fairchild strongly encourages customers to purchase Fairchild parts either directly from Fairchild or from Authorized Fairchild Distributors who are listed by country on our web page cited above. Products customers buy either from Fairchild directly or from Authorized Fairchild Distributors are genuine parts, have full traceability, meet Fairchild's quality standards for handling and storage and provide access to Fairchild's full range of up-to-date technical and product information. Fairchild and our Authorized Distributors will stand behind all warranties and will appropriately address any warranty issues that may arise. Fairchild will not provide any warranty coverage or other assistance for parts bought from Unauthorized Sources. Fairchild is committed to combat this global problem and encourage our customers to do their part in stopping this practice by buying direct or from authorized distributors.

# Mouser Electronics

Authorized Distributor

Click to View Pricing, Inventory, Delivery & Lifecycle Information:

[Fairchild Semiconductor:](#)

[FEBFL7733A\\_L52U050A](#)