

User Guide for
FEBFL7733A_L50U008A
Evaluation Board

8.4 W LED Driver at Universal Line

Featured Fairchild Product:
FL7733A

***Direct questions or comments
about this evaluation board to:
“Worldwide Direct Support”***

Fairchild Semiconductor.com

Table of Contents

1. Introduction.....	3
1.1. General Description of FL7733A	3
1.2. FL7733A Controller Features	3
1.3. FL7733A Controller Internal Block Diagram.....	4
2. Evaluation Board Specifications.....	5
3. Evaluation Board Photographs	6
4. Evaluation Board Printed Circuit Board (PCB).....	7
5. Evaluation Board Schematic.....	8
6. Evaluation Board Bill of Materials (BOM)	9
7. Transformer Design	10
8. Evaluation Board Performance	11
8.1. Startup.....	11
8.2. Operation Waveforms.....	12
8.3. Constant-Current Regulation	14
8.4. Short / Open-LED Protections	15
8.5. Efficiency	17
8.6. Power Factor (PF) & Total Harmonic Distortion (THD)	18
8.7. Harmonics.....	19
8.8. Operating Temperature	21
8.9. Electromagnetic Interference (EMI)	22
9. Revision History	23

This user guide supports the evaluation kit for the FL7733A. It should be used in conjunction with the FL7733A datasheet as well as Fairchild's application notes and technical support team. Please visit Fairchild's website at www.fairchildsemi.com.

1. Introduction

This document describes a solution for a universal AC input voltage LED driver using the FL7733A Primary-Side Regulator (PSR) single-stage controller. The input voltage range is $90 V_{RMS} \sim 265 V_{RMS}$ and there is one DC output with a constant current of 350 mA at 24 V. This document contains a general description of the FL7733A, the power supply solution specification, schematic, bill of materials, and typical operating characteristics.

1.1. General Description of FL7733A

The FL7733A is an active Power Factor Correction (PFC) controller used in a single-stage flyback topology or buck-boost topology. Primary-side regulation and a single-stage topology reduce external components, such as the input bulk capacitor and feedback circuitry, minimizing cost. To improve power factor and Total Harmonic Distortion (THD), constant on-time control is utilized with an internal error amplifier and a low bandwidth compensator. Precise constant-current control regulates accurate output current, independent of input voltage and output voltage. Operating frequency is proportionally changed by output voltage to guarantee Discontinuous Current Mode (DCM) operation, resulting in high efficiency and a simple design. The FL7733A provides open-LED, short-LED, and over-temperature protections.

1.2. Controller Features

High Performance

- Cost-Effective Solution; No Input Bulk Capacitor / Secondary Feedback Circuitry
- Power Factor Correction
- THD <10% Over Universal Input Line Range
- CC Tolerance:
 - < $\pm 1\%$ Over Universal Input Line Voltage Variation
 - < $\pm 1\%$ by 50% ~ 100% Load Voltage Variation
 - < $\pm 1\%$ by $\pm 20\%$ Magnetizing Inductance Variation
- High-Voltage Startup with VDD Regulation
- Adaptive Feedback Loop Control for No Overshoot at Startup

High Reliability

- LED Short / Open Protection
- Output Diode Short Protection
- Sensing Resistor Short / Open Protection
- V_{DD} Over-Voltage Protection (OVP)
- V_{DD} Under-Voltage Lockout (UVLO)
- Over-Temperature Protection (OTP)
- All Protections are Auto Restart
- Cycle-by-Cycle Current Limit
- Application Voltage Range: $80 V_{AC} \sim 308 V_{AC}$

1.3. Controller Internal Block Diagram

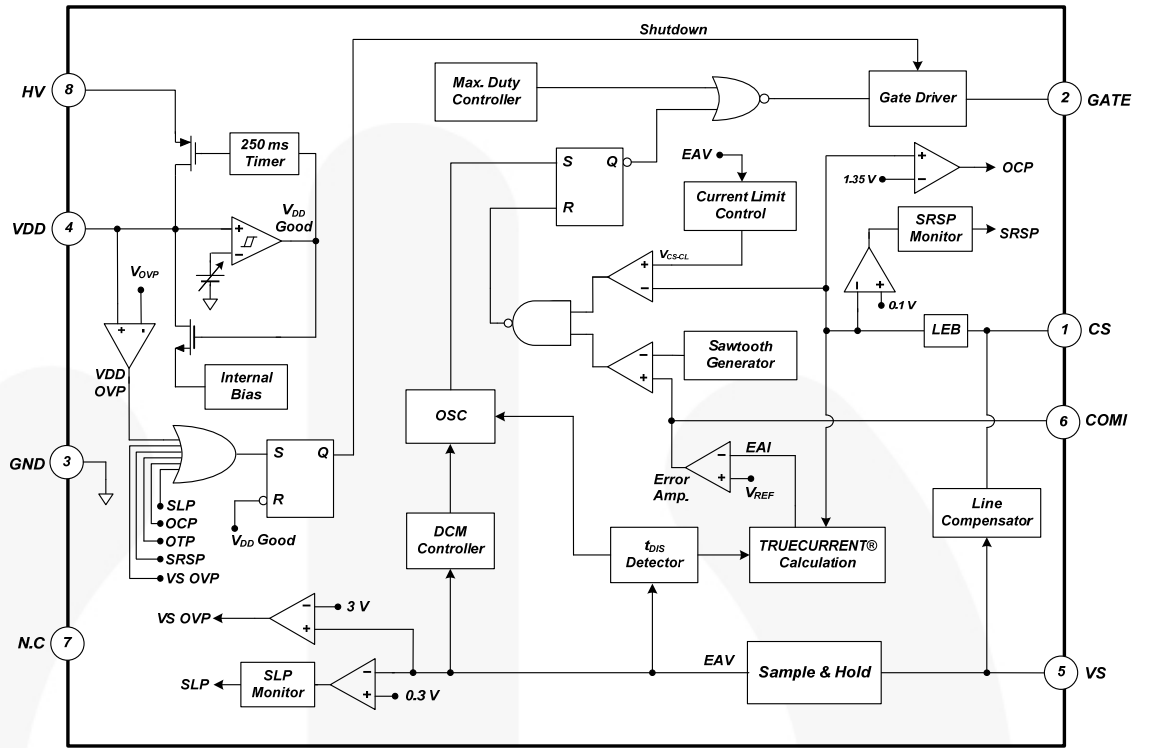

Figure 1. Block Diagram

2. Evaluation Board Specifications

Table 1. Specifications for LED Lighting Load

Description		Symbol	Value	Comments
Input	Voltage	$V_{IN.MIN}$	90 V _{AC}	Minimum AC Input Voltage
		$V_{IN.MAX}$	265 V _{AC}	Maximum AC Input Voltage
		$V_{IN.NOMINAL}$	120 V / 230 V	Nominal AC Input Voltage
	Frequency	f_{IN}	60 Hz / 50 Hz	Line Frequency
Output	Voltage	$V_{OUT.MIN}$	13 V	Minimum Output Voltage
		$V_{OUT.MAX}$	28 V	Maximum Output Voltage
		$V_{OUT.NOMINAL}$	24 V	Nominal Output Voltage
	Current	$I_{OUT.NOMINAL}$	350 mA	Nominal Output Current
		CC Deviation	< ±0.29%	Line Input Voltage Change: 90~265 V _{AC}
		< ±0.72%	Output Voltage Change: 13~28 V	
Efficiency		Eff_{90VAC}	86.41%	Efficiency at 90 V _{AC} Input Voltage
		Eff_{120VAC}	87.88%	Efficiency at 120 V _{AC} Input Voltage
		Eff_{140VAC}	88.25%	Efficiency at 140 V _{AC} Input Voltage
		Eff_{180VAC}	88.68%	Efficiency at 180 V _{AC} Input Voltage
		Eff_{230VAC}	88.95%	Efficiency at 230 V _{AC} Input Voltage
		Eff_{265VAC}	88.96%	Efficiency at 265 V _{AC} Input Voltage
PF/THD		PF / THD _{90VAC}	0.996 / 3.85%	PF/THD at 90 V _{AC} Input Voltage
		PF / THD _{120VAC}	0.992 / 3.61%	PF/THD at 120 V _{AC} Input Voltage
		PF / THD _{140VAC}	0.988 / 4.16%	PF/THD at 140 V _{AC} Input Voltage
		PF / THD _{180VAC}	0.975 / 4.90%	PF/THD at 180 V _{AC} Input Voltage
		PF / THD _{230VAC}	0.945 / 6.01%	PF/THD at 230 V _{AC} Input Voltage
		PF / THD _{265VAC}	0.914 / 7.06%	PF/THD at 265 V _{AC} Input Voltage
Temperature	FL7733A	$T_{FL7733A}$	52.9°C	Open-Frame Condition ($T_A = 25^\circ\text{C}$) FL7733A Temperature
	Primary MOSFET	T_{MOSFET}	61.2°C	Primary MOSFET Temperature
	Secondary Diode	T_{DIODE}	52.8°C	Secondary Diode Temperature
	Transformer	$T_{TRANSFORMER}$	56.0°C	Transformer Temperature

All data of the evaluation board measured with the board enclosed in a case and external temperature around 25°C.

3. Evaluation Board Photographs

Dimensions: 64 mm (L) x 26 mm (W) x 26 mm (H)

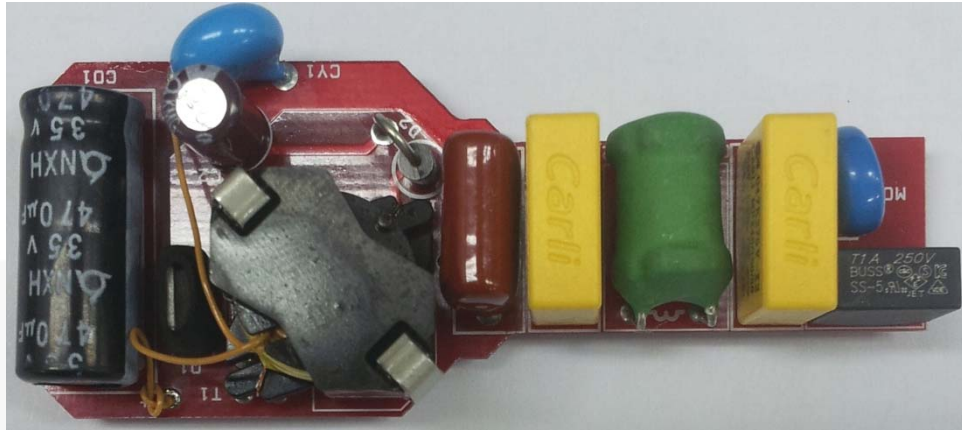

Figure 2. Top View

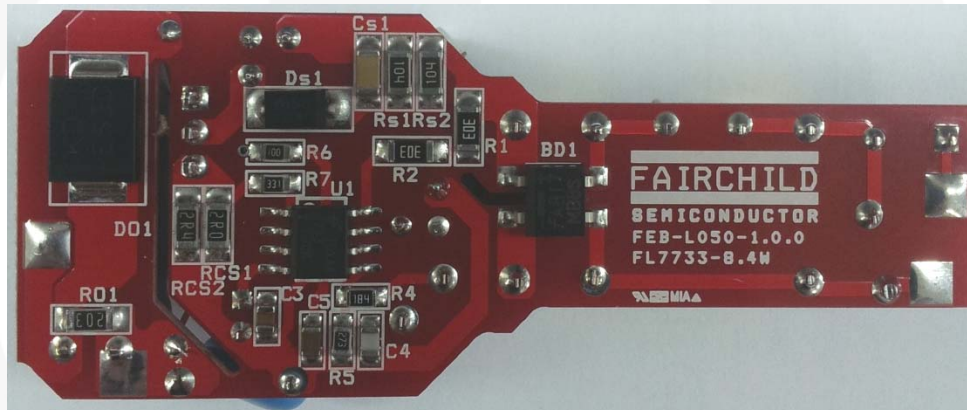

Figure 3. Bottom View

4. Evaluation Board Printed Circuit Board (PCB)

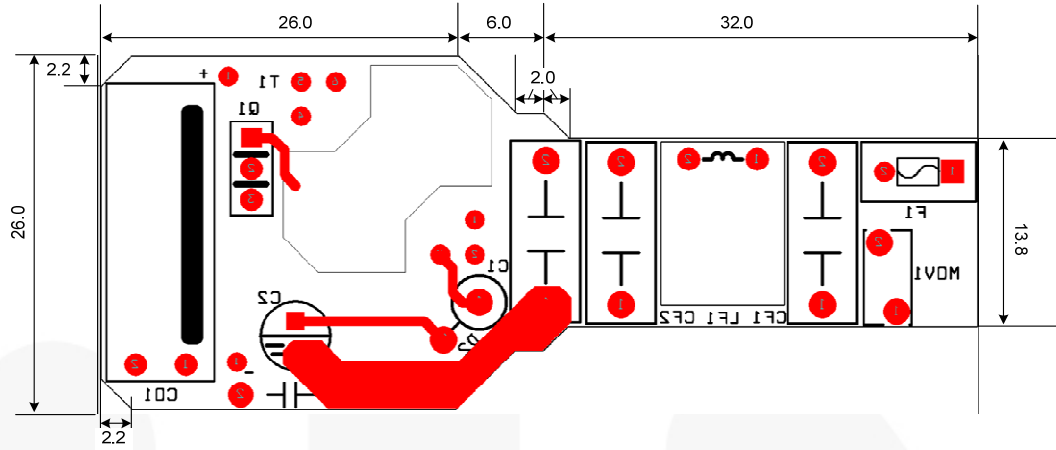

Figure 4. Top Pattern (in mm)

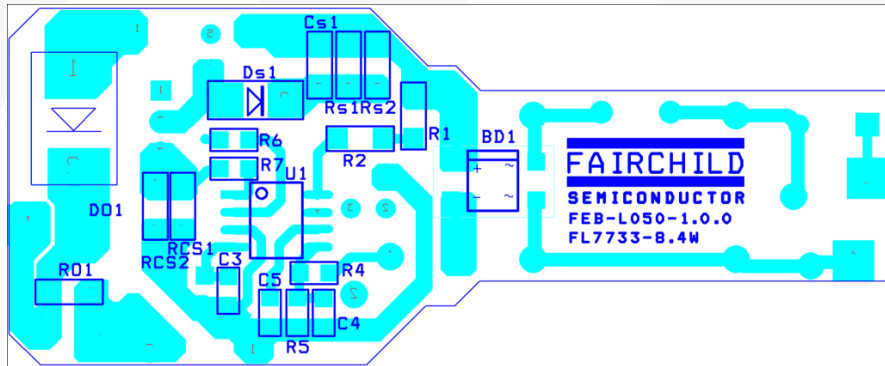

Figure 5. Bottom Pattern

5. Evaluation Board Schematic

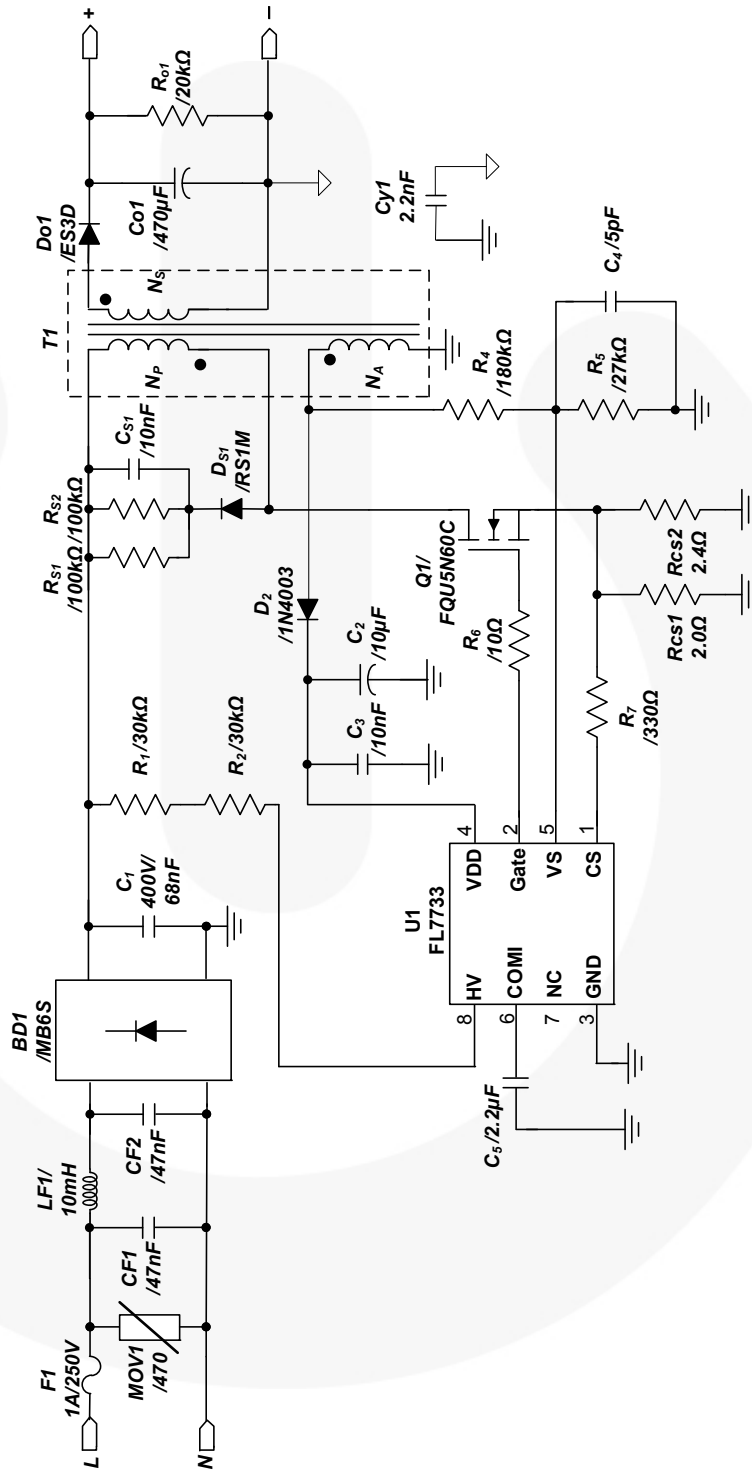

Figure 6. Schematic



6. Evaluation Board Bill of Materials (BOM)

Item No.	Part Reference	Part Number	Qty.	Description	Manufacturer
1	BD1	MB8S	1	Bridge Diode	Fairchild Semiconductor
2	CF1	MPX AC275V 473 K	2	47 nF / AC275V, X-Capacitor	Carli
3	CS1	C1206C103KDRACTU	1	10 nF / 1 kV, SMD Capacitor 1206	Kemet
4	CY1	SCFz2E222M10BW	1	2.2 nF / 250 V, Y-Capacitor	Samwha
5	Co1	NXH 470 μ F 35 V	1	470 μ F / 35 V, Electrolytic Capacitor	Samyoung
6	C1	MPE400V683K	1	68 nF / 400 V, MPE Film Capacitor	Sungho
7	C2	KMG10 μ F 35 V	1	10 μ F / 35 V, Electrolytic Capacitor	Samyoung
8	C3	C0805C104K5RACTU	1	100 nF / 50 V, SMD Capacitor 2012	Kemet
9	C4	C0805C519C3GACTU	1	5 pF / 25 V, SMD Capacitor 2012	Kemet
10	C5	C0805C225J3RACTU	1	2.2 μ F / 25 V, SMD Capacitor 2012	Kemet
11	DS1	RS1M	1	1000 V / 1 A, Ultra-Fast Recovery Diode	Fairchild Semiconductor
12	Do1	ES3D	1	200 V / 3 A, Fast Rectifier	Fairchild Semiconductor
13	D2	1N4003	1	200 V / 1 A, General-Purpose Rectifier	Fairchild Semiconductor
14	F1	SS-5-1A	1	250 V / 1 A, Fuse	Bussmann
15	LF1	R10302KT00	1	10 mH, Inductor, 8 \emptyset	Bosung
16	MOV1	SVC471D-07A	1	Metal Oxide Varistor	Samwha
17	Q1	FQU5N60C	1	600 V / 4 A, N-Channel MOSFET	Fairchild Semiconductor
18	R6	RC0805JR-0710RL	1	10 Ω , SMD Resistor 0805	Yageo
19	RS1, RS2	RC1206JR-07100KL	2	100 k Ω , SMD Resistor 1206	Yageo
20	Rcs1	RC1206JR-072RL	1	2 Ω , SMD Resistor 1206	Yageo
21	Rcs2	RC1206JR-072R4L	1	2.4 Ω , SMD Resistor 1206	Yageo
22	R7	RC0805JR-07330RL	1	330 Ω , SMD Resistor 0805	Yageo
23	Ro1	RC1206JR-0720KL	1	20 k Ω , SMD Resistor 1206	Yageo
24	R4	RC0805JR-07180KL	1	180 k Ω , SMD Resistor 0805	Yageo
25	R1, R2	RC1206JR-0730KL	2	30 k Ω , SMD Resistor 1206	Yageo
26	R5	RC0805JR-0727KL	1	27 k Ω , SMD Resistor 0805	Yageo
27	T1	RM6 Core	1	6-Pin, Transformer	TDK
28	U1	FL7733A	1	Main PSR Controller	Fairchild Semiconductor

7. Transformer Design

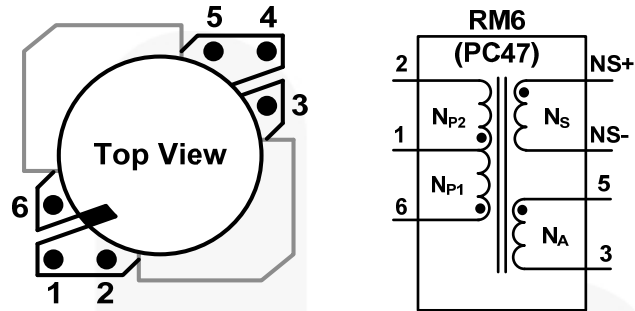

Figure 7. Transformer Bobbin Structure and Pin Configuration

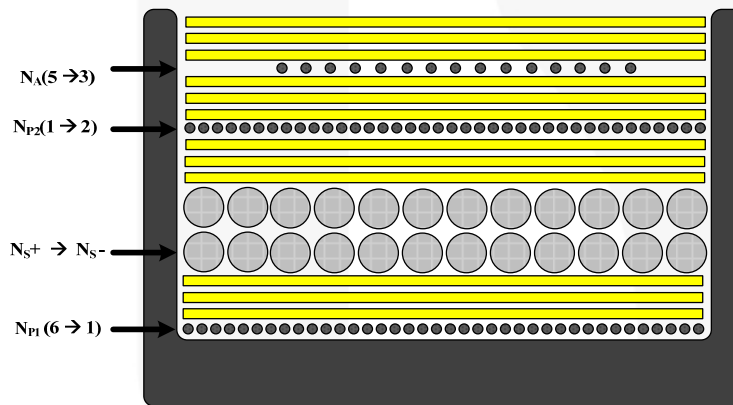

Figure 8. Transformer Winding Structure

Table 2. Winding Specifications

No.	Winding	Pin (S → F)	Wire	Turns	Winding Method
1	N_{P1}	6 → 1	0.20φ	54 Ts	Solenoid Winding
2	Insulation: Polyester Tape t = 0.025 mm, 3-Layer				
3	N_S	NS+ → NS-	0.25φ (TIW)	25 Ts	Solenoid Winding
4	Insulation: Polyester Tape t = 0.025 mm, 3-Layer				
5	N_{P2}	1 → 2	0.20φ	27 Ts	Solenoid Winding
6	Insulation: Polyester Tape t = 0.025 mm, 3-Layer				
7	N_A	5 → 3	0.20φ	17 Ts	Solenoid Winding
8	Insulation: Polyester Tape t = 0.025 mm, 3-Layer				

Table 3. Electrical Characteristics

	Pins	Specifications	Remark
Inductance	6 – 2	1.0 mH ±10%	60 kHz, 1 V
Leakage	6 – 2	10 μH	60 kHz, 1 V, Short All Output Pins

8. Evaluation Board Performance

Table 4. Test Condition & Equipment List

Ambient Temperature	$T_A = 25^\circ\text{C}$
Test Equipment	AC Power Source: PCR500L by Kikusui Power Analyzer: PZ4000000 by Yokogawa Electronic Load: PLZ303WH by KIKUSUI Multi Meter: 2002 by KEITHLEY, 45 by FLUKE Oscilloscope: 104Xi by LeCroy Thermometer: Thermal CAM SC640 by FLIR SYSTEMS LED: EHP-AX08EL/GT01H-P03 (3 W) by Everlight

8.1. Startup

Figure 9 and Figure 10 show the overall startup performance at rated output load. The output load current starts flowing after about 0.2 s and 0.1 s for input voltage 90 V_{AC} and 265 V_{AC} condition when the AC input power switch turns on. CH1: V_{DD} (10 V / div), CH2: V_{IN} (100 V / div), CH3: V_{LED} (20 V / div), CH4: I_{LED} (200 mA / div), Time Scale: (100 ms / div), Load: 7 series-LEDs.

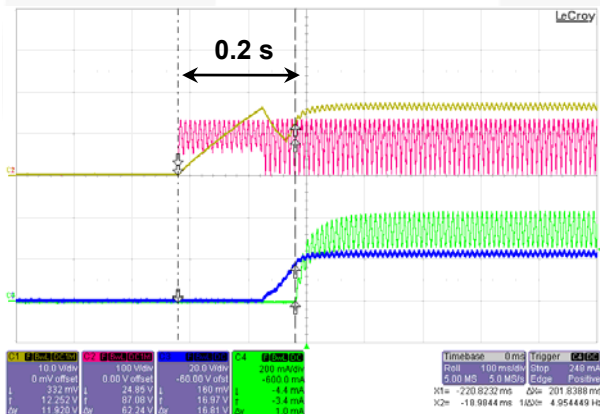

Figure 9. $V_{IN} = 90\text{ V}_{AC} / 60\text{ Hz}$

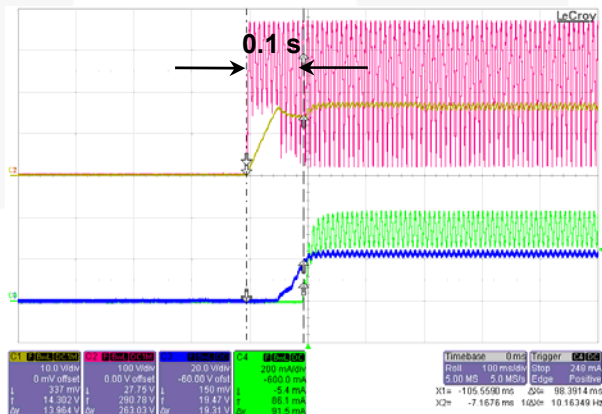

Figure 10. $V_{IN} = 120\text{ V}_{AC} / 60\text{ Hz}$

8.2. Operation Waveforms

Figure 11 to Figure 14 show AC input and output waveforms at rated output load. CH1: I_{IN} (200 mA / div), CH2: V_{IN} (100 V / div), CH3: V_{LED} (20 V / div), CH4: I_{LED} (200 mA / div), Time Scale: (5 ms / div), Load: 7 series LEDs.

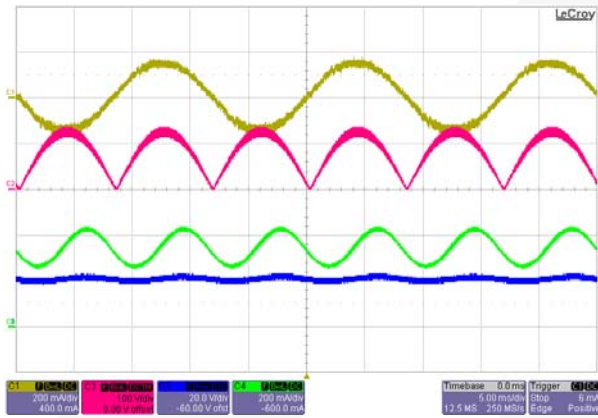

Figure 11. $V_{IN} = 90 V_{AC} / 60 \text{ Hz}$

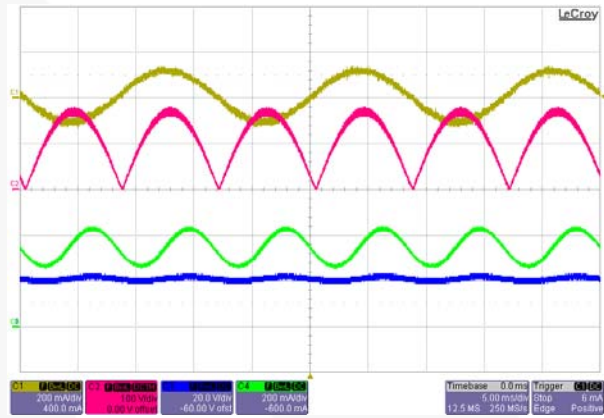

Figure 12. $V_{IN} = 120 V_{AC} / 60 \text{ Hz}$

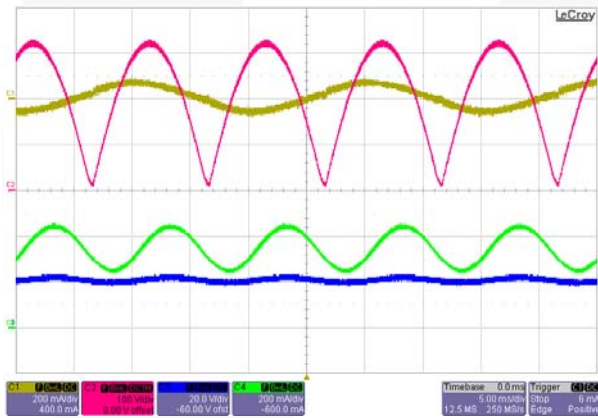

Figure 13. $V_{IN} = 230 V_{AC} / 50 \text{ Hz}$

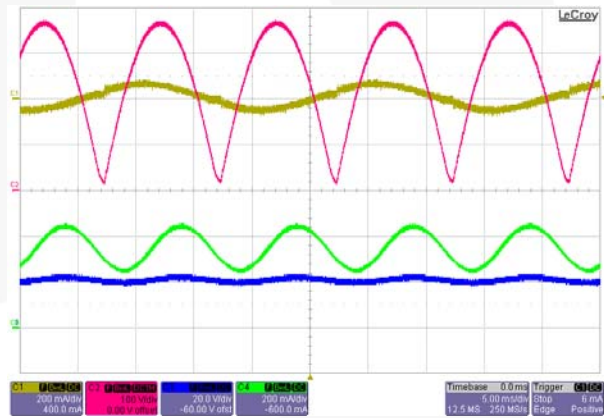

Figure 14. $V_{IN} = 265 V_{AC} / 50 \text{ Hz}$

Figure 15 to Figure 18 show key waveforms of single-stage flyback converter operation for line voltage at rated output load. CH1: V_{CS} (500 mA / div), CH2: V_{DS} (200 V / div), CH3: $V_{SEC-Diode}$ (100 V / div), CH4: $I_{SEC-Diode}$ (2.0 A / div), Load: 7 series-LEDs.

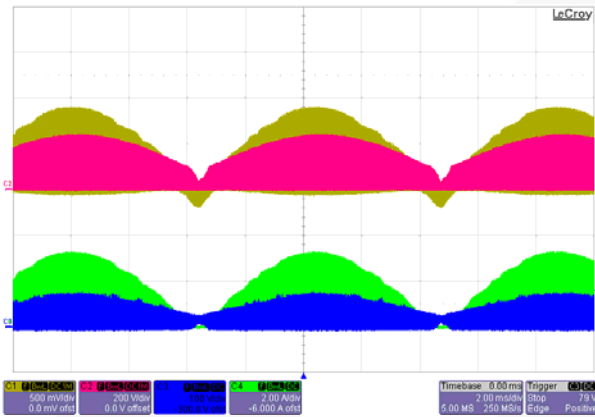

Figure 15. $V_{IN} = 90 V_{AC} / 60 Hz$, [2.0 ms / div]

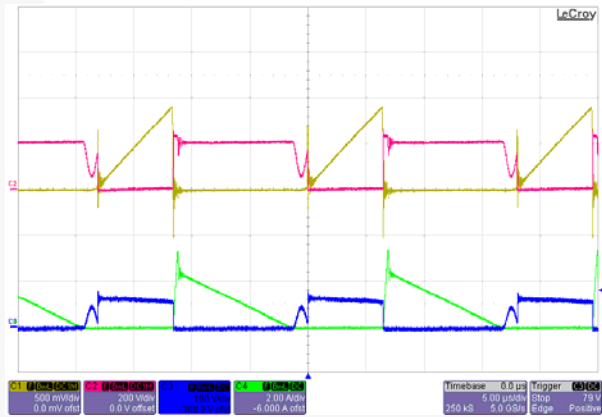

Figure 16. $V_{IN} = 90 V_{AC} / 60 Hz$, [5.0 μs / div]

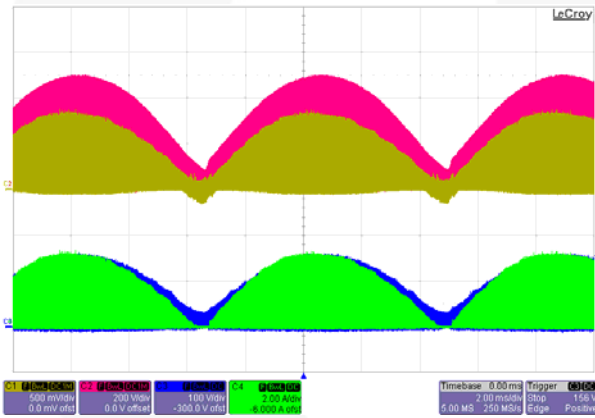

Figure 17. $V_{IN} = 265 V_{AC} / 60 Hz$, [2.0 ms / div]

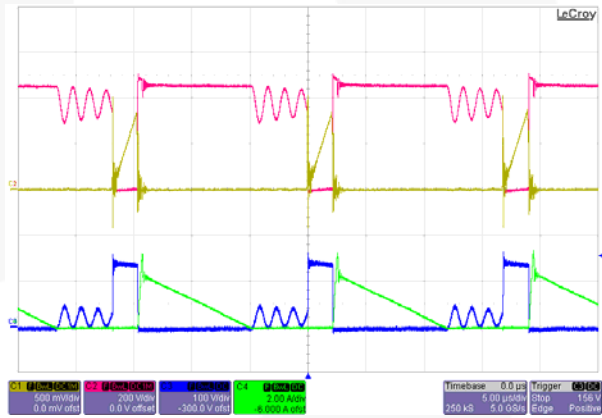

Figure 18. $V_{IN} = 265 V_{AC} / 60 Hz$, [5.0 μs / div]

8.3. Constant-Current Regulation

The output current deviation for wide output voltage ranges, from 13 V to 28 V, is less than $\pm 0.8\%$ at each line voltage. Line regulation at the rated output voltage (24 V) is less than $\pm 0.3\%$. The results were measured with E-load [CR Mode].

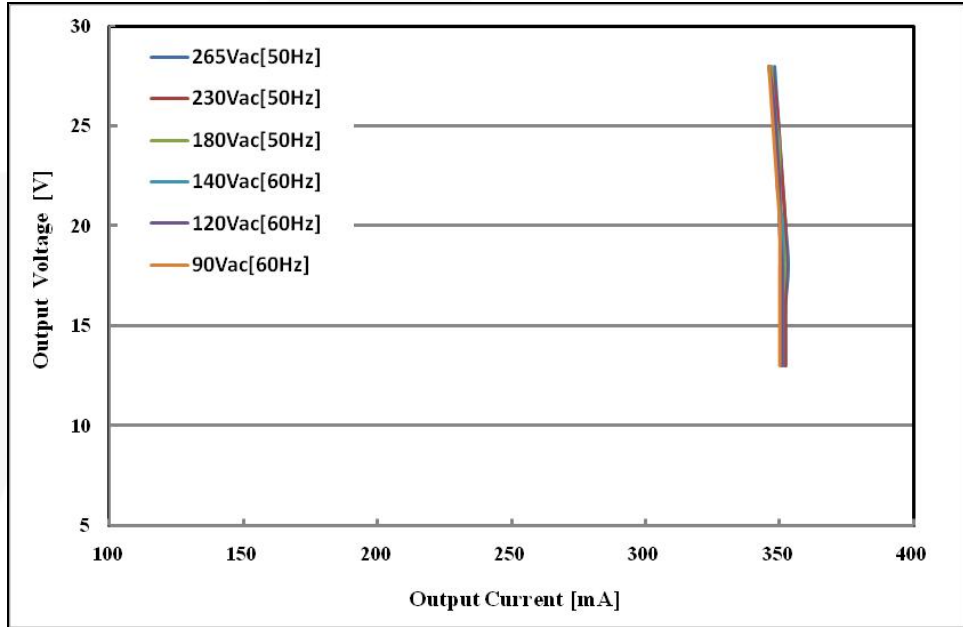

Figure 19. Constant-Current Regulation

Table 5. Constant-Current Regulation by Output Voltage Change (13 ~ 28 V)

Input Voltage	Min. Current [mA]	Max. Current [mA]	Tolerance
90 V _{AC} [60 Hz]	346	350	$\pm 0.57\%$
120 V _{AC} [60 Hz]	346	351	$\pm 0.72\%$
140 V _{AC} [60 Hz]	346	351	$\pm 0.72\%$
180 V _{AC} [50 Hz]	347	352	$\pm 0.72\%$
230 V _{AC} [50 Hz]	347	352	$\pm 0.72\%$
265 V _{AC} [50 Hz]	348	353	$\pm 0.71\%$

Table 6. Constant-Current Regulation by Line Voltage Change (90 ~ 265 V_{AC})

Output Voltage	90 V _{AC} [60 Hz]	120 V _{AC} [60 Hz]	140 V _{AC} [60 Hz]	180 V _{AC} [50 Hz]	230 V _{AC} [50 Hz]	265 V _{AC} [50 Hz]	Tolerance
26 V	347 mA	348 mA	348 mA	348 mA	349 mA	349 mA	$\pm 0.29\%$
24 V	348 mA	349 mA	349 mA	350 mA	350 mA	350 mA	$\pm 0.29\%$
22 V	349 mA	350 mA	349 mA	350 mA	351 mA	351 mA	$\pm 0.29\%$

8.4. Short- / Open-LED Protections

Figure 20 to Figure 23 show waveforms for protections operated when the LED is shorted and recovered. Once the LED short occurs, SCP is triggered and VDD starts hiccup mode with JFET regulation times [250 ms]. This lasts until the fault condition is eliminated. Systems can restart automatically when returned to normal condition. CH1: V_{GATE} (10 V / div), CH2: V_{IN} (100 V / div), CH3: V_{DD} (5 V / div), I_{OUT} (200 mA / div), Time Scale: (200 ms / div).

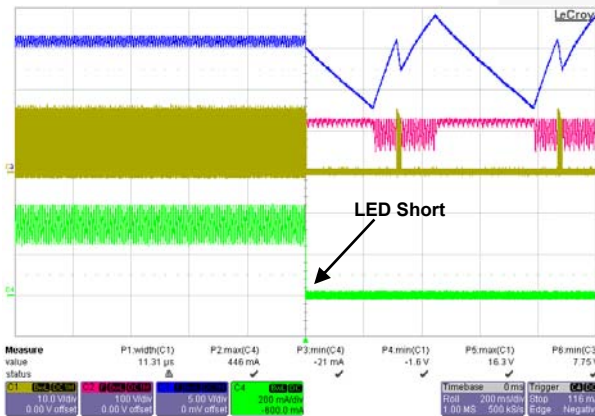

Figure 20. $V_{IN} = 90 V_{AC} / 60 Hz$, [LED Short]

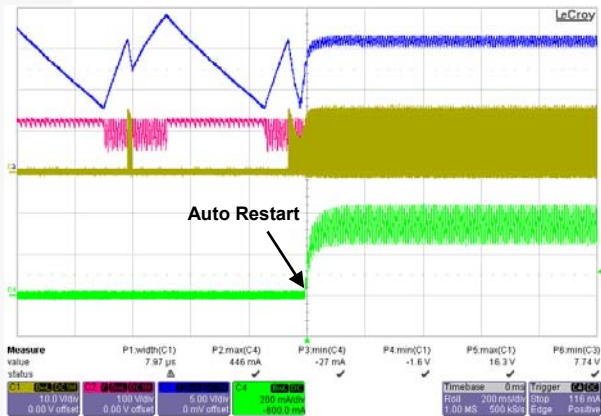

Figure 21. $V_{IN} = 90 V_{AC} / 60 Hz$, [LED Restore]

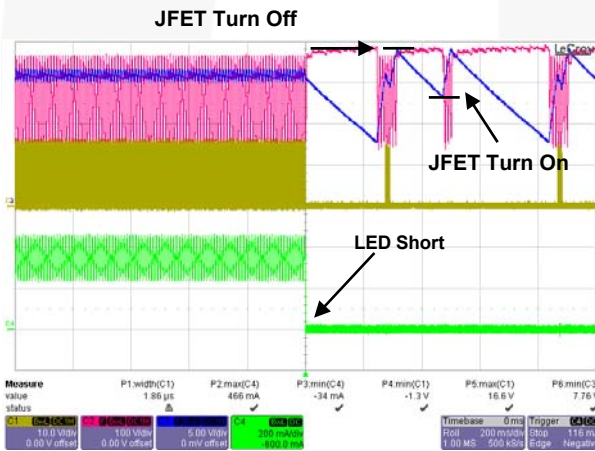

Figure 22. $V_{IN} = 265 V_{AC} / 50 Hz$, [LED Short]

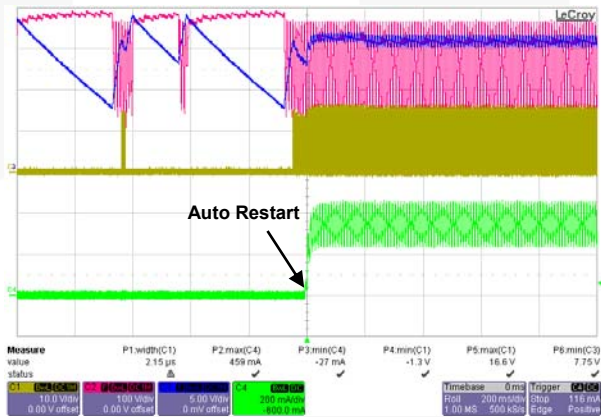

Figure 23. $V_{IN} = 265 V_{AC} / 50 Hz$, [LED Restore]

Figure 24 to Figure 27 show waveforms for protections operated when the LED is opened and recovered. Once the LED has opened, V_S OVP or V_{DD} OVP are triggered and V_{DD} starts “Hiccup” Mode with JFET regulation times [250 ms]. This lasts until the fault condition is eliminated. Systems can restart automatically when returned to normal condition. V_{GATE} (10 V / div), CH2: V_{IN} (100 V / div), CH3: V_{DD} (10 V / div), V_{OUT} (10 V / div), Time Scale: (200 ms / div).

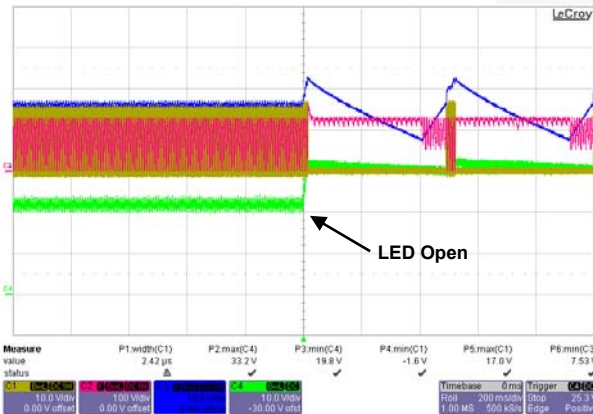

Figure 24. $V_{IN} = 90 V_{AC} / 60 \text{ Hz}$, [LED Short]

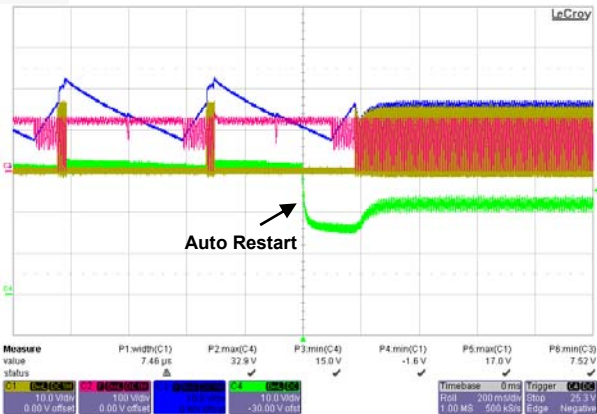

Figure 25. $V_{IN} = 90 V_{AC} / 60 \text{ Hz}$, [LED Restore]

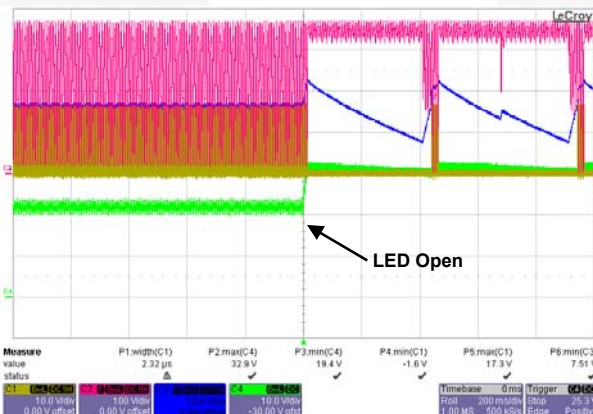

Figure 26. $V_{IN} = 265 V_{AC} / 50 \text{ Hz}$, [LED Short]

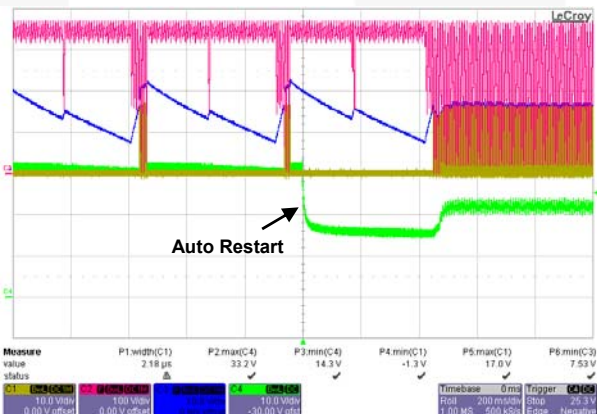

Figure 27. $V_{IN} = 265 V_{AC} / 50 \text{ Hz}$, [LED Restore]

If the LED load is re-connected after an open-LED condition, the output capacitor is quickly discharged through the LED load and the inrush current by the discharge could destroy LED load.

8.5. Efficiency

System efficiency is 86.41% ~ 88.96% over input voltages 90 ~ 265 V_{AC}. The results were measured using actual, rated LED loads 30 minutes after startup.

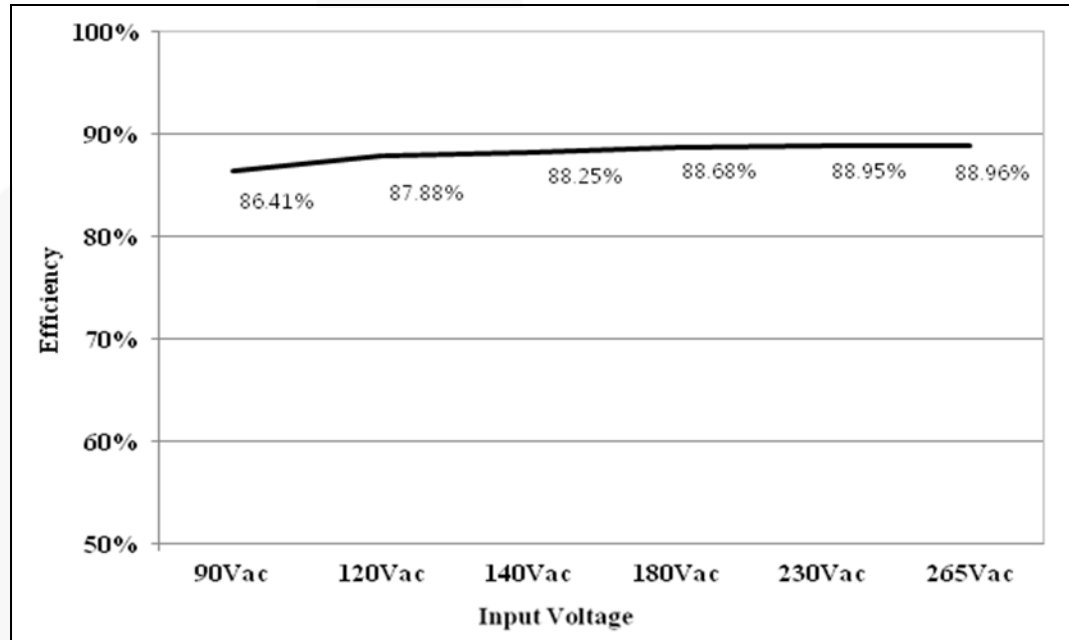

Figure 28. System Efficiency

Table 7. System Efficiency

Input Voltage	Input Power	Output Current	Output Voltage	Output Power	Efficiency
90 V _{AC} [60 Hz]	9.52 W	0.351 A	23.43 V	8.23 W	86.41%
120 V _{AC} [60 Hz]	9.39 W	0.352 A	23.45 V	8.25 W	87.88%
140 V _{AC} [60 Hz]	9.38 W	0.352 A	23.49 V	8.28 W	88.25%
180 V _{AC} [50 Hz]	9.33 W	0.354 A	23.40 V	8.27 W	88.68%
230 V _{AC} [50 Hz]	9.35 W	0.355 A	23.42 V	8.32 W	88.95%
265 V _{AC} [50 Hz]	9.38 W	0.356 A	23.46 V	8.34 W	88.96%

8.6. Power Factor (PF) & Total Harmonic Distortion (THD)

The FL7733A evaluation board shows excellent THD performance, much less than 10%. The results were measured using actual, rated LED loads ten (10) minutes after startup.

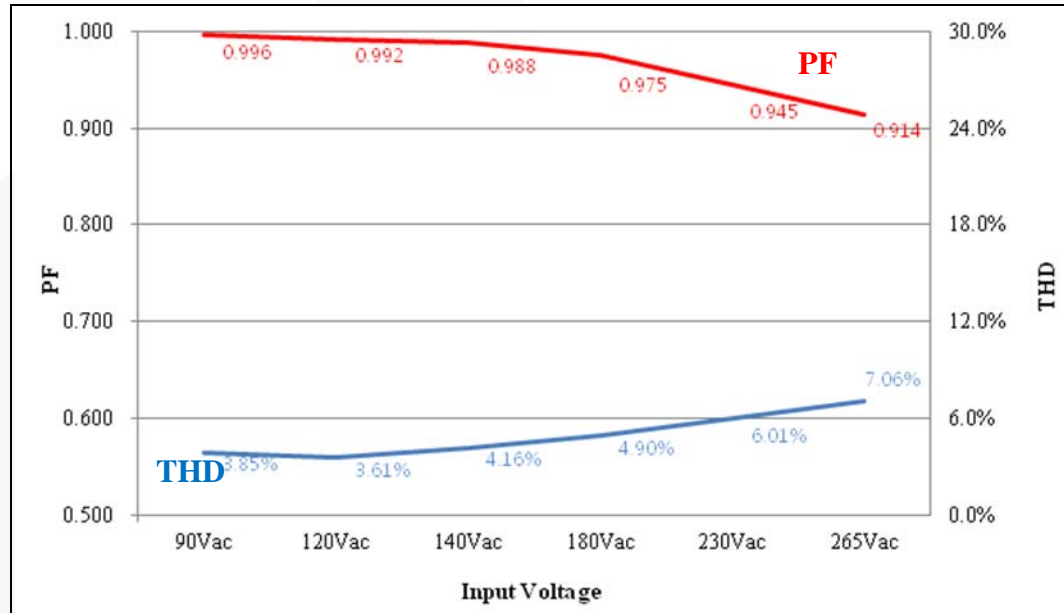

Figure 29. Power Factor & Total Harmonic Distortion

Table 8. Power Factor & Total Harmonic Distortion

Input Voltage	Output Current	Output Voltage	Power Factor	THD
90 V _{AC} [60 Hz]	0.351 A	23.43 V	0.996	3.85%
120 V _{AC} [60 Hz]	0.352 A	23.45 V	0.992	3.61%
140 V _{AC} [60 Hz]	0.352 A	23.49 V	0.988	4.16%
180 V _{AC} [50 Hz]	0.354 A	23.40 V	0.975	4.90%
230 V _{AC} [50 Hz]	0.355 A	23.42 V	0.945	6.01%
265 V _{AC} [50 Hz]	0.356 A	23.46 V	0.914	7.06%

8.7. Harmonics

Figure 30 to Figure 33 show current harmonics measured using actual, rated LED loads.

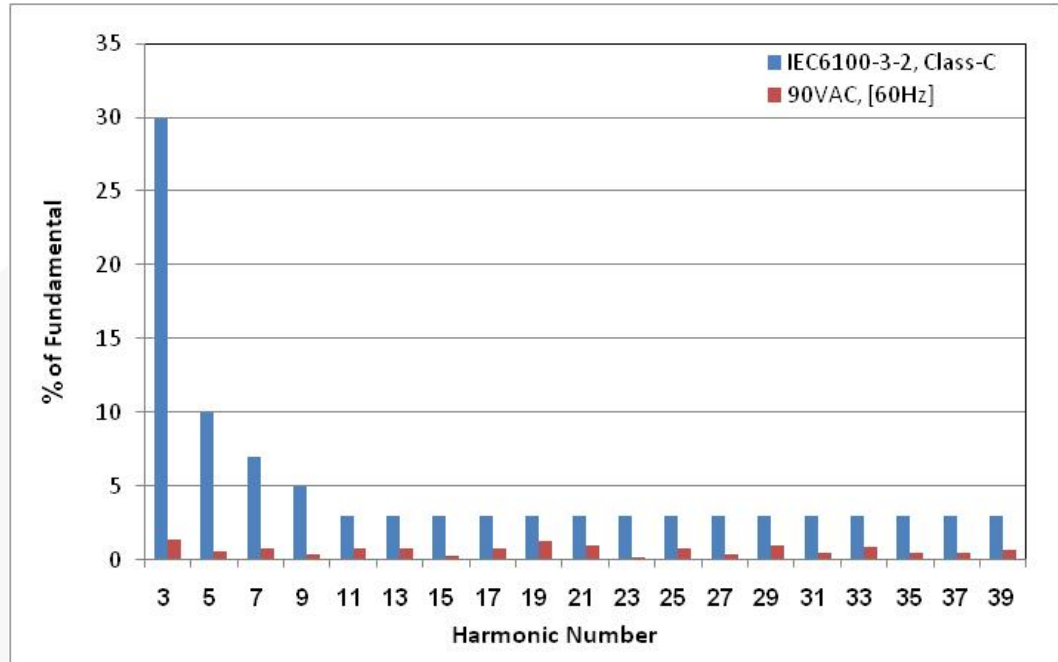

Figure 30. $V_{IN} = 90 V_{AC} / 60 \text{ Hz}$

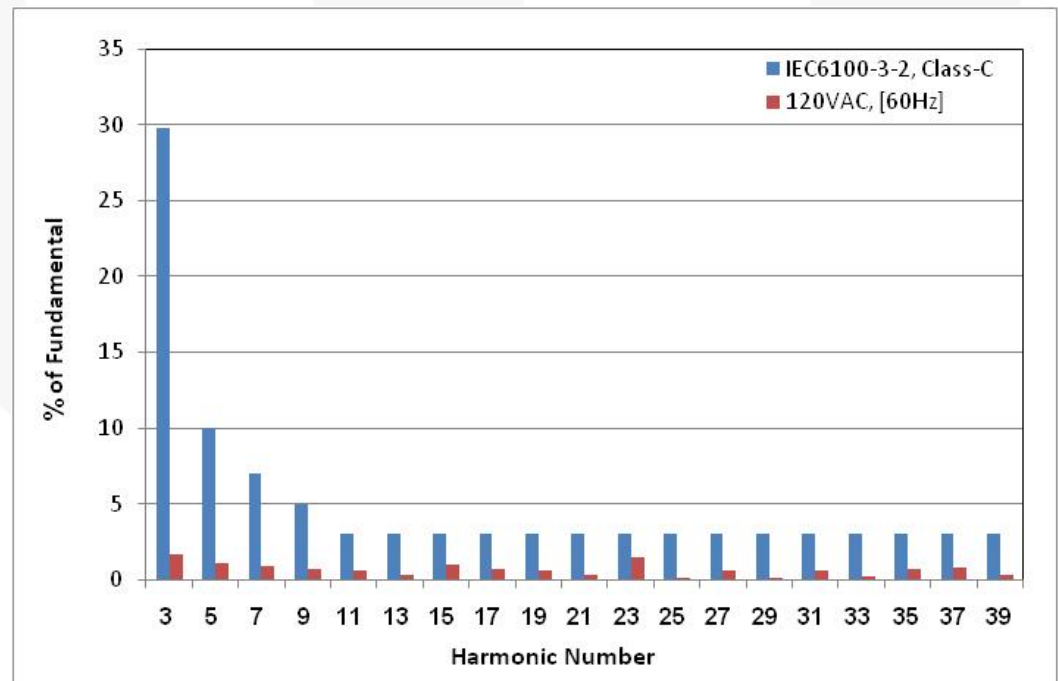

Figure 31. $V_{IN} = 120 V_{AC} / 60 \text{ Hz}$

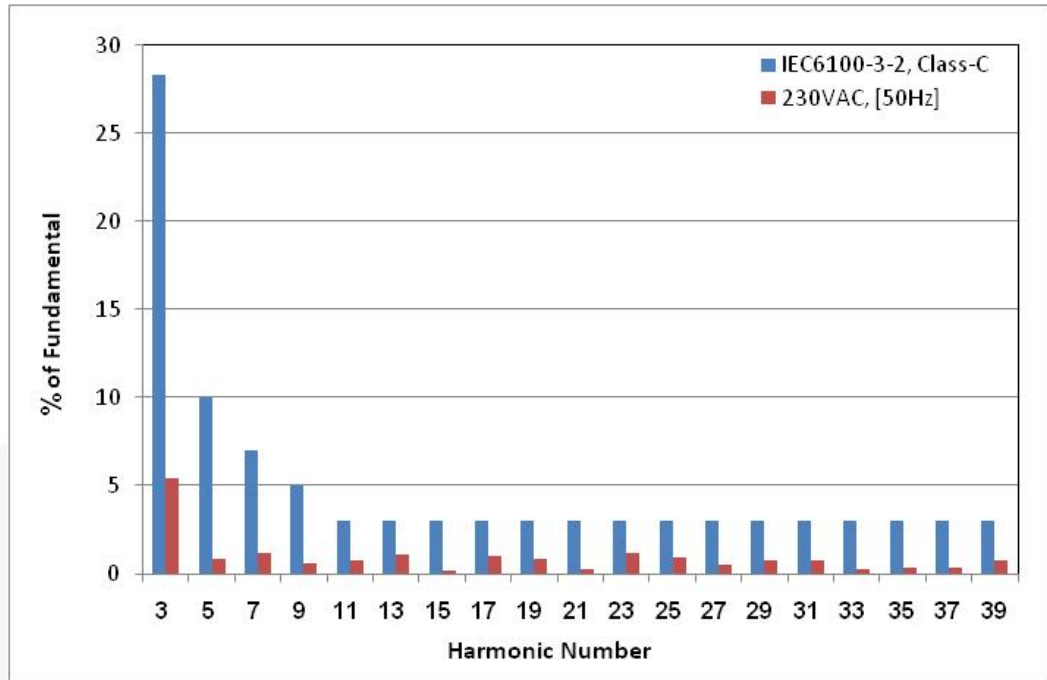

Figure 32. $V_{IN} = 230 V_{AC} / 50 \text{ Hz}$

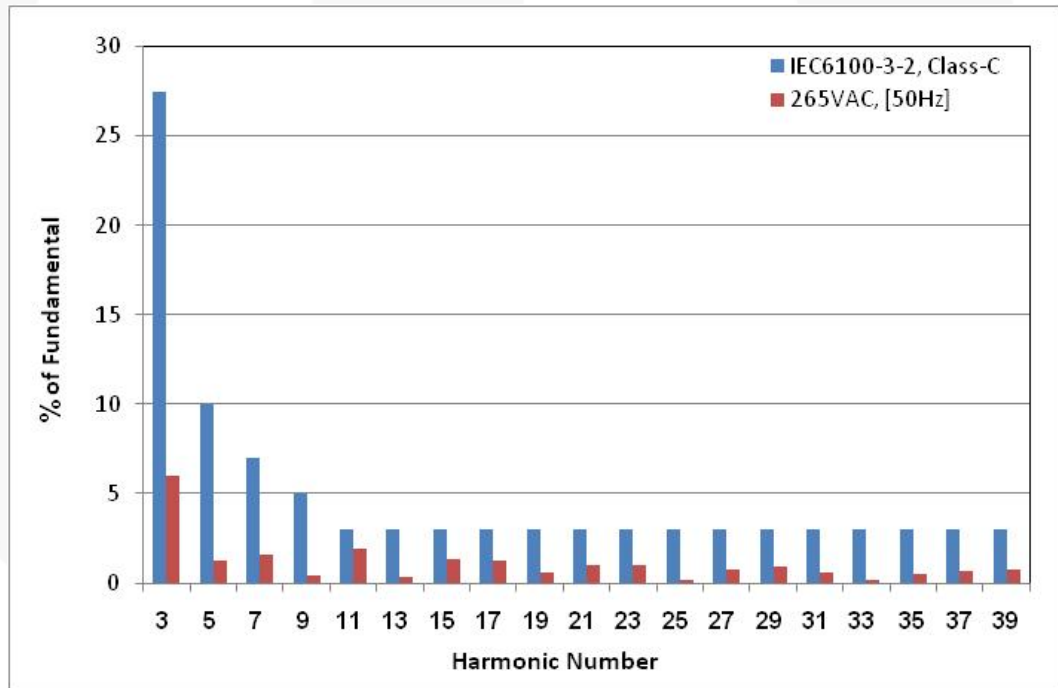

Figure 33. $V_{IN} = 265 V_{AC} / 50 \text{ Hz}$

8.8. Operating Temperature

Temperatures on all components for this board are less than 62°C. The results were measured using actual, rated LED loads 60 minutes after startup.

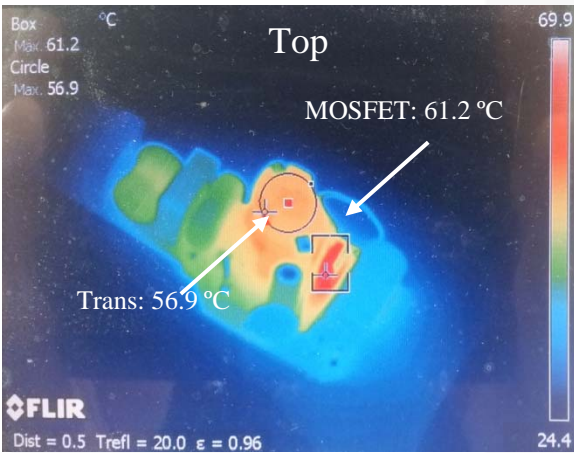

Figure 34. $V_{IN} = 90 V_{AC} / 60 \text{ Hz}$

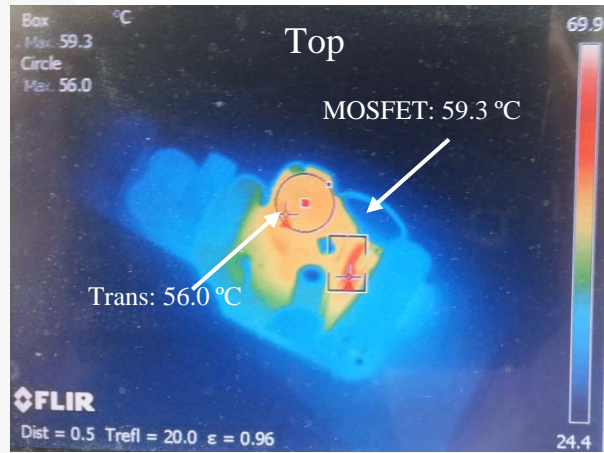

Figure 35. $V_{IN} = 265 V_{AC} / 50 \text{ Hz}$

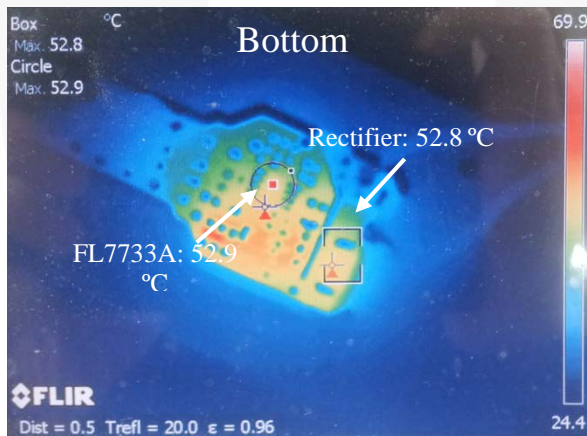

Figure 36. $V_{IN} = 90 V_{AC} / 60 \text{ Hz}$

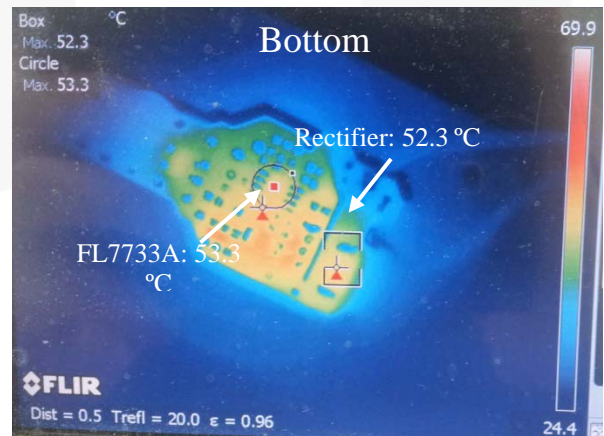

Figure 37. $V_{IN} = 265 V_{AC} / 50 \text{ Hz}$

The IC temperature can be improved by the PCB layout.

8.9. Electromagnetic Interference (EMI)

All measurements were conducted in observance of EN55022 criteria. The results were measured using actual, rated LED loads 30 minutes after startup.

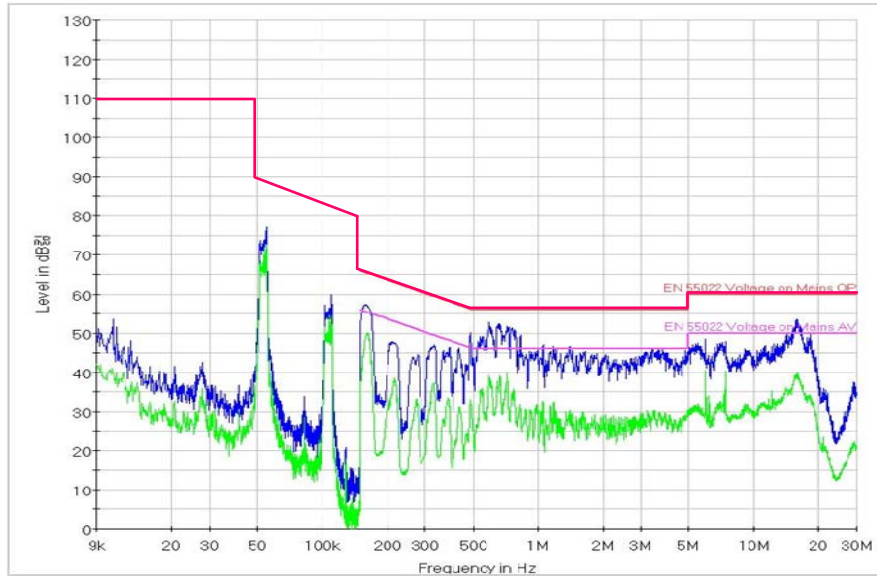

Figure 38. V_{IN} [110 V_{AC}, LIVE]

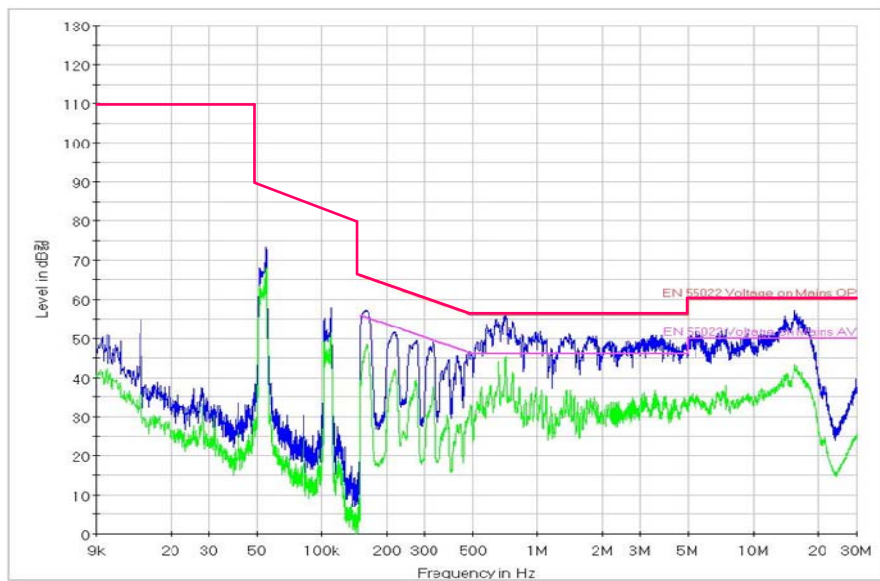

Figure 39. V_{IN} [220 V_{AC}, Neutral]



9. Revision History

Rev.	Date	Description
1.0	Oct. 2014	Initial Release

WARNING AND DISCLAIMER

Replace components on the Evaluation Board only with those parts shown on the parts list (or Bill of Materials) in the Users' Guide. Contact an authorized Fairchild representative with any questions.

The Evaluation board (or kit) is for demonstration purposes only and neither the Board nor this User's Guide constitute a sales contract or create any kind of warranty, whether express or implied, as to the applications or products involved. Fairchild warrants that its products meet Fairchild's published specifications, but does not guarantee that its products work in any specific application. Fairchild reserves the right to make changes without notice to any products described herein to improve reliability, function, or design. Either the applicable sales contract signed by Fairchild and Buyer or, if no contract exists, Fairchild's standard Terms and Conditions on the back of Fairchild invoices, govern the terms of sale of the products described herein.

DISCLAIMER

FAIRCHILD SEMICONDUCTOR RESERVES THE RIGHT TO MAKE CHANGES WITHOUT FURTHER NOTICE TO ANY PRODUCTS HEREIN TO IMPROVE RELIABILITY, FUNCTION, OR DESIGN. FAIRCHILD DOES NOT ASSUME ANY LIABILITY ARISING OUT OF THE APPLICATION OR USE OF ANY PRODUCT OR CIRCUIT DESCRIBED HEREIN; NEITHER DOES IT CONVEY ANY LICENSE UNDER ITS PATENT RIGHTS, NOR THE RIGHTS OF OTHERS.

LIFE SUPPORT POLICY

FAIRCHILD'S PRODUCTS ARE NOT AUTHORIZED FOR USE AS CRITICAL COMPONENTS IN LIFE SUPPORT DEVICES OR SYSTEMS WITHOUT THE EXPRESS WRITTEN APPROVAL OF THE PRESIDENT OF FAIRCHILD SEMICONDUCTOR CORPORATION.

As used herein:

1. Life support devices or systems are devices or systems which, (a) are intended for surgical implant into the body, or (b) support or sustain life, or (c) whose failure to perform when properly used in accordance with instructions for use provided in the labeling, can be reasonably expected to result in significant injury to the user.
2. A critical component is any component of a life support device or system whose failure to perform can be reasonably expected to cause the failure of the life support device or system, or to affect its safety or effectiveness.

ANTI-COUNTERFEITING POLICY

Fairchild Semiconductor Corporation's Anti-Counterfeiting Policy. Fairchild's Anti-Counterfeiting Policy is also stated on our external website, www.fairchildsemi.com, under Sales Support.

Counterfeiting of semiconductor parts is a growing problem in the industry. All manufacturers of semiconductor products are experiencing counterfeiting of their parts. Customers who inadvertently purchase counterfeit parts experience many problems such as loss of brand reputation, substandard performance, failed applications, and increased cost of production and manufacturing delays. Fairchild is taking strong measures to protect ourselves and our customers from the proliferation of counterfeit parts. Fairchild strongly encourages customers to purchase Fairchild parts either directly from Fairchild or from Authorized Fairchild Distributors who are listed by country on our web page cited above. Products customers buy either from Fairchild directly or from Authorized Fairchild Distributors are genuine parts, have full traceability, meet Fairchild's quality standards for handling and storage and provide access to Fairchild's full range of up-to-date technical and product information. Fairchild and our Authorized Distributors will stand behind all warranties and will appropriately address any warranty issues that may arise. Fairchild will not provide any warranty coverage or other assistance for parts bought from Unauthorized Sources. Fairchild is committed to combat this global problem and encourage our customers to do their part in stopping this practice by buying direct or from authorized distributors.

Mouser Electronics

Authorized Distributor

Click to View Pricing, Inventory, Delivery & Lifecycle Information:

[Fairchild Semiconductor:](#)

[FEBFL7733A_L50U008A](#)