

ASSP Mobile Communication Systems

Piezoelectric SAW BPF (700 to 1700 MHz)

F5/F6 Series (K2 type)

■ DESCRIPTION

The F5CE/F6CE-K2 series of SAW band pass filters is available in the 700-1700 MHz frequency range and exhibit high stability by using single crystal Lithium Tantalate (LiTaO_3) with a large electro-mechanical coefficient. The F5CE/F6CE-K2 series provides low insertion loss and wide passband width by taking advantage of Fujitsu's unique "Ladder-type" design.

The F5CE/F6CE-K2 series is housed in a small package (3.0 mm square) contributing to a significant savings in mounting space. This package is 40 % smaller than our F5CH-L2 series (3.8 mm square) . Typical applications for the F5CE/F6CE-K2 series include RF interstage filter in mobile communications systems. Standard devices are available for AMPS/TDMA/CDMA,GSM, EGSM and various Japanese standards. If higher attenuation is preferred, our F5CE-D2 series is also recommended.

■ FEATURES

- Low insertion loss and high stopband attenuation
- Wide pass band width
- Compact and light package (3.0 mm sq.)
- External matching circuits are not required. (50 ohms I/O)
- Surface mount package (SMT)
- Standard devices are available for mobile communication standards (AMPS/CDMA/TDMA,GSM,EGSM,PDC800, J-CDMA, PDC 1.5 G)

■ PACKAGE

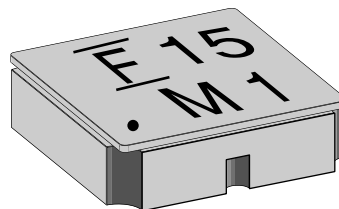

F5/F6 Series (K2 type)

■ PIN ASSIGNMENT

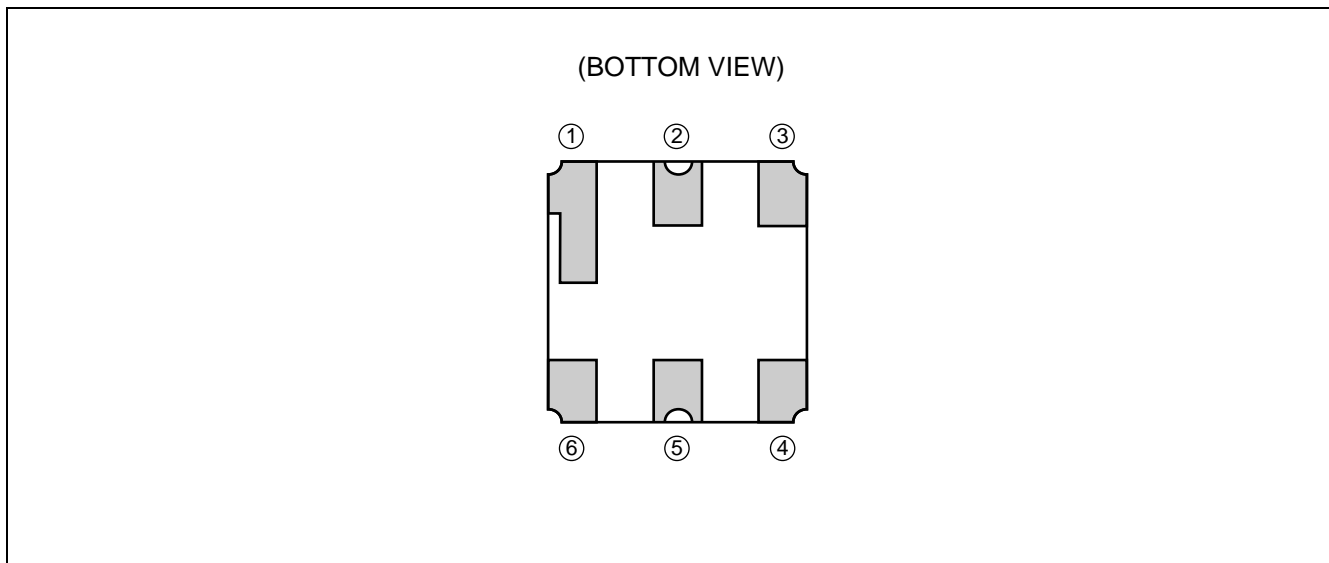

■ PIN DESCRIPTION

Pin No.	Pin name	Description
1	GND	Ground Pin
2	IN	Input Pin
3	GND	Ground Pin
4	GND	Ground Pin
5	OUT	Output Pin
6	GND	Ground Pin

■ ABSOLUTE MAXIMUM RATINGS

Parameter	Symbol	Rating		Unit
		Min.	Max.	
Operating temperature	Ta	-30	+85	°C
Storage temperature	Tstg	-40	+100	°C
Input level	P _{IN}	—	+23	dBm
Input DC voltage	DC	-5	+5	V

WARNING: Piezoelectric devices can be permanently damaged by application of stress (voltage, current, temperature, etc.) in excess of absolute maximum ratings. Do not exceed these ratings.

F5/F6 Series (K2 type)

RECOMMENDED OPERATING CONDITIONS

Parameter	Symbol	Value		Unit
		Min.	Max.	
Operating temperature	Ta	-30	+85	°C

WARNING: The recommended operating conditions are required in order to ensure the normal operation of the piezoelectric device. All of the device's electrical characteristics are warranted when the device is operated within this range.

Always use piezoelectric devices within their recommended operating condition ranges. Operation outside these ranges may adversely affect reliability and could result in device failure.

No warranty is made with respect to uses, operating conditions, or combinations not represented on the data sheet. Users considering application outside the listed conditions are advised to contact their FUJITSU representatives beforehand.

STANDARD FREQUENCIES

System		Center freq. (MHz)	B/W (MHz)	Part symbol	Part number	Remarks
AMPS /TDMA /CDMA	Tx	836.5	25	25	FAR-F5CE-836M50-K225	Low loss type
		836.5	25	30	FAR-F5CE-836M50-K230	High Att. type
		836.5	25	36	FAR-F5CE-836M50-K236	Low loss type
		836.5	25	89	FAR-F5CE-836M50-K289	High Att. type
	Rx	881.5	25	35	FAR-F5CE-881M50-K235	Low loss type
		881.5	25	10	FAR-F5CE-881M50-K210	High Att. type
GSM	Tx	902.5	25	13	FAR-F5CE-902M50-K213	
	Rx	947.5	25	33	FAR-F5CE-947M50-K233	Ultra low loss
		947.5	25	14	FAR-F5CE-947M50-K214	Low loss type
		947.5	25	28	FAR-F5CE-947M50-K228	High Att. type
EGSM	Tx	897.5	35	26	FAR-F5CE-897M50-K226	
		897.5	35	31	FAR-F5CE-897M50-K231	Low loss type
	Rx	942.5	35	88	FAR-F5CE-942M50-K288	Low loss type
		942.5	35	37	FAR-F5CE-942M50-K237	
PDC800 (20 MHz passband width standard)	Tx	950.0	20	01	FAR-F5CE-950M00-K201	
	Rx	820.0	20	02	FAR-F5CE-820M00-K202	Low loss type
		820.0	20	04	FAR-F5CE-820M00-K204	High Att. type
J-CDMA	Tx	906.0	38	11	FAR-F5CE-906M00-K211	Low loss type
		906.0	38	19	FAR-F5CE-906M00-K219	
		906.0	38	15	FAR-F5CE-906M00-K215	High Att. type
		906.0	38	38	FAR-F5CE-906M00-K238	
	Rx	851.0	38	12	FAR-F5CE-851M00-K212	
PDC1.5 G	Tx	1441.0	24	20	FAR-F6CE1G4410-K220	
	Rx	1489.0	24	21	FAR-F6CE1G4890-K221	
	Lo	1619.0	24	22	FAR-F6CE1G6190-K222	

F5/F6 Series (K2 type)

■ ELECTRICAL CHARACTERISTICS

1. AMPS/TDMA/CDMA (Tx) Low Loss type

Part number : FAR-F5CE-836M50-K225

(Ta = -30 °C to +85 °C)

Parameter	Conditions	Value			Unit	Remarks
		Min.	Typ.	Max.		
Insertion loss	824 MHz to 849 MHz	—	2.0	2.5	dB	
Inband ripple	824 MHz to 849 MHz	—	0.9	1.5	dB	
Absolute attenuation	DC to 800 MHz	20	23	—	dB	
	869 MHz to 894 MHz	28	30	—	dB	
	894 MHz to 2000 MHz	22	25	—	dB	
Inband VSWR (Return loss)	824 MHz to 849 MHz	— (6.2)	2.6 (7.0)	2.9 (—)	— (dB)	

2. AMPS/TDMA/CDMA (Tx) High Attenuation type

Part number : FAR-F5CE-836M50-K230

(Ta = -30 °C to +85 °C)

Parameter	Conditions	Value			Unit	Remarks
		Min.	Typ.	Max.		
Insertion loss	824 MHz to 849 MHz	—	2.7	3.5	dB	
Inband ripple	824 MHz to 849 MHz	—	1.0	2.0	dB	
Absolute attenuation	DC to 800 MHz	28	30	—	dB	
	869 MHz to 894 MHz	30	43	—	dB	
	894 MHz to 1200 MHz	35	37	—	dB	
	1200 MHz to 2000 MHz	20	25	—	dB	
Inband VSWR (Return loss)	824 MHz to 849 MHz	— (8.5)	1.7 (11.7)	2.2 (—)	— (dB)	

F5/F6 Series (K2 type)

3. AMPS/TDMA/CDMA (Tx) Low Loss type Part number : FAR-F5CE-836M50-K236

(Ta = -30 °C to +85 °C)

Parameter	Conditions	Value			Unit	Remarks
		Min.	Typ.	Max.		
Insertion loss	824 MHz to 849 MHz	—	2.2	3.0	dB	
Inband ripple	824 MHz to 849 MHz	—	0.9	1.7	dB	
Absolute attenuation	DC to 800 MHz	25	26	2.2	dB	
	869 MHz to 894 MHz	30	35	—	dB	
	894 MHz to 1050 MHz	25	27	—	dB	
	1050 MHz to 1210 MHz	25	28	—	dB	
	1210 MHz to 2000 MHz	20	27	—	dB	
Inband VSWR (Return loss)	824 MHz to 849 MHz	— (8.5)	1.8 (10.9)	2.2 (—)	— (dB)	

4. AMPS/TDMA/CDMA (Tx) High Attenuation type Part number : FAR-F5CE-836M500-K289

(Ta = -30 °C to +85 °C)

Parameter	Conditions	Value			Unit	Remarks
		Min.	Typ.	Max.		
Insertion loss	824 MHz to 849 MHz	—	3.0	3.8	dB	
Inband ripple	824 MHz to 849 MHz	—	1.0	2.0	dB	
Absolute attenuation	DC to 800 MHz	30	32	—	dB	
	869 MHz to 894 MHz	36	45	—	dB	
	894 MHz to 1050 MHz	38	43	—	dB	
	1050 MHz to 1210 MHz	35	37	—	dB	
	1210 MHz to 2000 MHz	20	28	—	dB	
Inband VSWR (Return loss)	824 MHz to 849 MHz	— (9.0)	2.0 (9.5)	2.1 (—)	— (dB)	

F5/F6 Series (K2 type)

5. AMPS/TDMA/CDMA (Rx) Low Loss type Part number : FAR-F5CE-881M50-K235

(Ta = -30 °C to +85 °C)

Parameter	Conditions	Value			Unit	Remarks
		Min.	Typ.	Max.		
Insertion loss	869 MHz to 894 MHz	—	2.0	3.0	dB	
Inband ripple	869 MHz to 894 MHz	—	0.8	1.8	dB	
Absolute attenuation	DC to 800 MHz	20	24	—	dB	
	824 MHz to 849 MHz	35	40	—	dB	
	939 MHz to 1049 MHz	28	31	—	dB	
	1049 MHz to 1200 MHz	28	32	—	dB	
	1200 MHz to 2000 MHz	25	30	—	dB	
Inband VSWR (Return loss)	869 MHz to 894 MHz	— (9.5)	1.7 (11.7)	2.0 (—)	— (dB)	

6. AMPS/TDMA/CDMA (Rx) High Attenuation type Part number : FAR-F5CE-881M50-K210

(Ta = -30 °C to +85 °C)

Parameter	Conditions	Value			Unit	Remarks
		Min.	Typ.	Max.		
Insertion loss	869 MHz to 894 MHz	—	2.7	3.5	dB	
Inband ripple	869 MHz to 894 MHz	—	1.0	2.0	dB	
Absolute attenuation	DC to 849 MHz	30	32	—	dB	
	914 MHz to 939 MHz	20	38	—	dB	
	939 MHz to 1049 MHz	30	35	—	dB	
	1049 MHz to 2000 MHz	25	30	—	dB	
Inband VSWR (Return loss)	869 MHz to 894 MHz	— (7.4)	2.0 (9.5)	2.5 (—)	— (dB)	

F5/F6 Series (K2 type)

7. GSM (Tx)

Part number : FAR-F5CE-902M50-K213

(Ta = -30 °C to +85 °C)

Parameter	Conditions	Value			Unit	Remarks
		Min.	Typ.	Max.		
Insertion loss	890 MHz to 915 MHz	—	3.0	3.5	dB	
Inband ripple	890 MHz to 915 MHz	—	1.0	2.0	dB	
Absolute attenuation	DC to 845 MHz	30	32	—	dB	
	845 MHz to 870 MHz	20	35	—	dB	
	935 MHz to 980 MHz	20	35	—	dB	
	980 MHz to 1200 MHz	35	37	—	dB	
	1200 MHz to 2000 MHz	30	35	—	dB	
Inband VSWR (Return loss)	890 MHz to 915 MHz	— (7.4)	2.0 (9.5)	2.5 (—)	— (dB)	

8. GSM (Rx) Ultra Low Loss type

Part number : FAR-F5CE-947M50-K233

(Ta = -30 °C to +85 °C)

Parameter	Conditions	Value			Unit	Remarks
		Min.	Typ.	Max.		
Insertion loss	935 MHz to 960 MHz	—	1.7	2.0	dB	
Inband ripple	935 MHz to 960 MHz	—	0.5	1.0	dB	
Absolute attenuation	DC to 905 MHz	17	19	—	dB	
	905 MHz to 915 MHz	15	25	—	dB	
	980 MHz to 1000 MHz	10	20	—	dB	
	1000 MHz to 1500 MHz	18	21	—	dB	
	1500 MHz to 2000 MHz	20	25	—	dB	
Inband VSWR (Return loss)	935 MHz to 960 MHz	— (7.4)	2.0 (9.5)	2.5 (—)	— (dB)	

F5/F6 Series (K2 type)

9. GSM (Rx) Low Loss type

Part number : FAR-F5CE-947M50-K214

(Ta = -30 °C to +85 °C)

Parameter	Conditions	Value			Unit	Remarks
		Min.	Typ.	Max.		
Insertion loss	935 MHz to 960 MHz	—	2.7	3.0	dB	
Inband ripple	935 MHz to 960 MHz	—	1.0	1.5	dB	
Absolute attenuation	DC to 800 MHz	20	25	—	dB	
	890 MHz to 915 MHz	20	35	—	dB	
	980 MHz to 1025 MHz	20	25	—	dB	
	1025 MHz to 1600 MHz	27	32	—	dB	
	1600 MHz to 2000 MHz	25	30	—	dB	
Inband VSWR (Return loss)	935 MHz to 960 MHz	— (7.4)	2.0 (9.5)	2.5 (—)	— (dB)	

10. GSM (Rx) High Attenuation type

Part number : FAR-F5CE-947M50-K228

(Ta = -30 °C to +85 °C)

Parameter	Conditions	Value			Unit	Remarks
		Min.	Typ.	Max.		
Insertion loss	935 MHz to 960 MHz	—	3.0	3.5	dB	
Inband ripple	935 MHz to 960 MHz	—	1.0	2.0	dB	
Absolute attenuation	DC to 855 MHz	30	32	—	dB	
	855 MHz to 871 MHz	32	37	—	dB	
	890 MHz to 915 MHz	20	35	—	dB	
	980 MHz to 1025 MHz	20	35	—	dB	
	1025 MHz to 1105 MHz	33	37	—	dB	
	1105 MHz to 2000 MHz	30	37	—	dB	
	2000 MHz to 3000 MHz	25	30	—	dB	
Inband VSWR (Return loss)	935 MHz to 960 MHz	— (7.4)	2.0 (9.5)	2.5 (—)	— (dB)	

F5/F6 Series (K2 type)

11. EGSM (Tx)

Part number : FAR-F5CE-897M50-K226

(Ta = -30 °C to +85 °C)

Parameter	Conditions	Value			Unit	Remarks
		Min.	Typ.	Max.		
Insertion loss	880 MHz to 915 MHz	—	2.5	3.5	dB	
Inband ripple	880 MHz to 915 MHz	—	1.0	2.0	dB	
Absolute attenuation	DC to 845 MHz	20	23	—	dB	
	925 MHz to 935 MHz	4.5	8	—	dB	Ta = -30 °C to +25 °C
		7			dB	Ta = +25 °C to +85 °C
	935 MHz to 2000 MHz	25	30	—	dB	
Inband VSWR (Return loss)	880 MHz to 915 MHz	— (6.8)	2.2 (8.5)	2.7 (—)	— (dB)	

12. EGSM (Tx) Low Loss type

Part number : FAR-F5CE-897M50-K231

(Ta = -30 °C to +85 °C)

Parameter	Conditions	Value			Unit	Remarks
		Min.	Typ.	Max.		
Insertion loss	880 MHz to 915 MHz	—	2.3	3.0	dB	
Inband ripple	880 MHz to 915 MHz	—	1.0	1.5	dB	
Absolute attenuation	DC to 800 MHz	17	19	—	dB	
	800 MHz to 860 MHz	15	25	—	dB	
	925 MHz to 935 MHz	4	—	—	dB	
	935 MHz to 960 MHz	20	25	—	dB	
	960 MHz to 1850 MHz	20	25	—	dB	
	1850 MHz to 3000 MHz	7	12	—	dB	
Inband VSWR (Return loss)	880 MHz to 915 MHz	— (8.5)	2.0 (9.5)	2.2 (—)	— (dB)	

F5/F6 Series (K2 type)

13. EGSM (Rx) Low Loss type Part number : FAR-F5CE-942M50-K288

(Ta = -30 °C to +85 °C)

Parameter	Conditions	Value			Unit	Remarks
		Min.	Typ.	Max.		
Insertion loss	925 MHz to 960 MHz	—	2.0	2.5	dB	Ta = +25 °C ± 2 °C
				2.7	dB	Ta = -10 °C to +60 °C
				3.0	dB	Ta = -30 °C to +85 °C
Inband ripple	925 MHz to 960 MHz	—	0.5	1.5	dB	
Absolute attenuation	DC to 905 MHz	17	18	—	dB	
	905 MHz to 915 MHz	13	16	—	dB	Ta = +25 °C ± 2 °C
		8			dB	Ta = -10 °C to +60 °C
		5			dB	Ta = -30 °C to +85 °C
	980 MHz to 1000 MHz	13	20	—	dB	
1000 MHz to 2000 MHz	20	22	—	dB		
Inband VSWR (Return loss)	925 MHz to 960 MHz	— (6.8)	2.2 (8.5)	2.7 (—)	— (dB)	

F5/F6 Series (K2 type)

14. EGSM (Rx)

Part number : FAR-F5CE-942M50-K237

(Ta = -30 °C to +85 °C)

Parameter	Conditions	Value			Unit	Remarks
		Min.	Typ.	Max.		
Insertion loss	925 MHz to 960 MHz	—	2.5	3.0	dB	Ta = +10 °C to +60 °C
		—	—	3.5		Ta = -30 °C to +85 °C
Inband ripple	925 MHz to 960 MHz	—	1.3	1.9	dB	
Absolute attenuation	DC to 100 MHz	30	33	—	dB	
	100 MHz to 700 MHz	23	25	—	dB	
	700 MHz to 800 MHz	25	28	—	dB	
	800 MHz to 890 MHz	28	31	—	dB	
	890 MHz to 905 MHz	35	41	—	dB	
	905 MHz to 915 MHz	15	20	—	dB	Ta = +25 °C ± 2 °C
		11	20	—	dB	Ta = +10 °C to +60 °C
		7	10	—	dB	Ta = -30 °C to +85 °C
	980 MHz to 1000 MHz	20	33	—	dB	
	1000 MHz to 1200 MHz	30	32	—	dB	
	1200 MHz to 1550 MHz	30	35	—	dB	
	1550 MHz to 1950 MHz	25	31	—	dB	
	1950 MHz to 2800 MHz	20	27	—	dB	
2800 MHz to 3000 MHz	15	23	—	dB		
Inband VSWR (Return loss)	925 MHz to 960 MHz	— (6.5)	2.6 (7.0)	2.8 (—)	— (dB)	

15. PDC800 (Tx)

Part number : FAR-F5CE-950M00-K201

(Ta = -30 °C to +85 °C)

Parameter	Conditions	Value			Unit	Remarks
		Min.	Typ.	Max.		
Insertion loss	940 MHz to 960 MHz	—	3.0	3.5	dB	
Inband ripple	940 MHz to 960 MHz	—	1.5	2.0	dB	
Absolute attenuation	DC to 680 MHz	30	36	—	dB	
	680 MHz to 696 MHz	33	37	—	dB	
	810 MHz to 830 MHz	35	40	—	dB	
	1015 MHz to 1106 MHz	40	44	—	dB	
	1106 MHz to 2000 MHz	30	37	—	dB	
Inband VSWR (Return loss)	940 MHz to 960 MHz	— (7.4)	1.8 (10.9)	2.5 (—)	— (dB)	

F5/F6 Series (K2 type)

16. PDC800 (Rx) Low Loss type Part number : FAR-F5CE-820M00-K202

(Ta = -30 °C to +85 °C)

Parameter	Conditions	Value			Unit	Remarks
		Min.	Typ.	Max.		
Insertion loss	810 MHz to 830 MHz	—	2.1	2.5	dB	
Inband ripple	810 MHz to 830 MHz	—	1.4	1.9	dB	
Absolute attenuation	DC to 700 MHz	20	24	—	dB	
	875 MHz to 1070 MHz	25	28	—	dB	
	1070 MHz to 1090 MHz	26	30	—	dB	
	1090 MHz to 2000 MHz	20	28	—	dB	
Inband VSWR (Return loss)	810 MHz to 830 MHz	— (9.5)	1.7 (11.7)	2.0 (—)	— (dB)	

17. PDC800 (Rx) High Attenuation type Part number : FAR-F5CE-820M00-K204

(Ta = -30 °C to +85 °C)

Parameter	Conditions	Value			Unit	Remarks
		Min.	Typ.	Max.		
Insertion loss	810 MHz to 830 MHz	—	3.0	3.5	dB	
Inband ripple	810 MHz to 830 MHz	—	1.5	2.0	dB	
Absolute attenuation	DC to 130 MHz	35	41	—	dB	
	130 MHz to 760 MHz	30	34	—	dB	
	855 MHz to 875 MHz	35	38	—	dB	
	875 MHz to 1090 MHz	33	38	—	dB	
	1090 MHz to 2000 MHz	30	38	—	dB	
Inband VSWR (Return loss)	810 MHz to 830 MHz	— (7.4)	2.0 (9.5)	2.5 (—)	— (dB)	

F5/F6 Series (K2 type)

18. J-CDMA (Tx) Low Loss type Part number : FAR-F5CE-906M00-K211

(Ta = -30 °C to +85 °C)

Parameter	Conditions	Value			Unit	Remarks
		Min.	Typ.	Max.		
Insertion loss	887 MHz to 925 MHz	—	2.5	3.5	dB	
Inband ripple	887 MHz to 925 MHz	—	1.0	2.0	dB	
Absolute attenuation	DC to 720 MHz	17	20	—	dB	
	720 MHz to 800 MHz	20	22	—	dB	
	832 MHz to 870 MHz	28	30	—	dB	
	940 MHz to 942 MHz	15	25	—	dB	
	942 MHz to 950 MHz	20	30	—	dB	
	950 MHz to 2000 MHz	20	23	—	dB	
Absolute attenuation	2000 MHz to 3000 MHz	15	17	—	dB	
	Inband VSWR (Return loss)	887 MHz to 925 MHz	— (7.4)	2.3 (8.1)	2.5 (—)	— (dB)

19. J-CDMA (Tx) Part number : FAR-F5CE-906M00-K219

(Ta = -30 °C to +85 °C)

Parameter	Conditions	Value			Unit	Remarks
		Min.	Typ.	Max.		
Insertion loss	887 MHz to 925 MHz	—	2.7	3.7	dB	
Inband ripple	887 MHz to 925 MHz	—	1.0	2.2	dB	
Absolute attenuation	DC to 720 MHz	20	22	—	dB	
	720 MHz to 800 MHz	20	23	—	dB	
	832 MHz to 870 MHz	32	33	—	dB	
	940 MHz to 942 MHz	15	25	—	dB	
	942 MHz to 950 MHz	20	30	—	dB	
	950 MHz to 2000 MHz	20	23	—	dB	
Absolute attenuation	2000 MHz to 3000 MHz	15	17	—	dB	
	Inband VSWR (Return loss)	887 MHz to 925 MHz	— (6.8)	2.2 (8.5)	2.7 (—)	— (dB)

F5/F6 Series (K2 type)

20. J-CDMA (Tx) High Attenuation type Part number : FAR-F5CE-906M00-K215

(Ta = -30 °C to +85 °C)

Parameter	Conditions	Value			Unit	Remarks
		Min.	Typ.	Max.		
Insertion loss	887 MHz to 925 MHz	—	3.0	4.5	dB	
Inband ripple	887 MHz to 925 MHz	—	1.5	3.0	dB	
Absolute attenuation	DC to 720 MHz	25	26	—	dB	
	720 MHz to 800 MHz	25	30	—	dB	
	832 MHz to 870 MHz	30	35	—	dB	
	940 MHz to 942 MHz	20	25	—	dB	
	942 MHz to 950 MHz	25	30	—	dB	
	950 MHz to 2000 MHz	20	25	—	dB	
	2000 MHz to 3000 MHz	15	20	—	dB	
Inband VSWR (Return loss)	887 MHz to 925 MHz	— (5.1)	3.0 (6.0)	3.5 (—)	— (dB)	

21. J-CDMA (Tx) Part number : FAR-F5CE-906M00-K238

(Ta = -30 °C to +85 °C)

Parameter	Conditions	Value			Unit	Remarks
		Min.	Typ.	Max.		
Insertion loss	887 MHz to 925 MHz	—	2.7	4.0	dB	
Inband ripple	887 MHz to 925 MHz	—	1.0	2.3	dB	
Absolute attenuation	DC to 720 MHz	23	25	—	dB	
	720 MHz to 800 MHz	25	27	—	dB	
	832 MHz to 870 MHz	37	40	—	dB	
	940 MHz to 942 MHz	15	23	—	dB	
	942 MHz to 950 MHz	20	28	—	dB	
	950 MHz to 2000 MHz	25	30	—	dB	
	2000 MHz to 3000 MHz	20	25	—	dB	
Inband VSWR (Return loss)	887 MHz to 925 MHz	— (5.6)	2.2 (8.5)	3.2 (—)	— (dB)	

F5/F6 Series (K2 type)

22. J-CDMA (Rx)

Part number : FAR-F5CE-851M00-K212

(Ta = -30 °C to +85 °C)

Parameter	Conditions	Value			Unit	Remarks
		Min.	Typ.	Max.		
Insertion loss	832 MHz to 870 MHz	—	2.5	3.5	dB	
Inband ripple	832 MHz to 870 MHz	—	1.0	2.0	dB	
Absolute attenuation	DC to 170 MHz	20	24	—	dB	
	170 MHz to 720 MHz	18	20	—	dB	
	720 MHz to 770 MHz	20	22	—	dB	
	770 MHz to 815 MHz	25	27	—	dB	
	818 MHz	15	40	—	dB	
	887 MHz to 897 MHz	20	30	—	dB	
	897 MHz to 925 MHz	23	25	—	dB	
	925 MHz to 1100 MHz	22	24	—	dB	
1100 MHz to 2000 MHz	20	24	—	dB		
Inband VSWR (Return loss)	832 MHz to 870 MHz	— (6.0)	2.7 (6.8)	3.0 (—)	— (dB)	

23. PDC1.5 G (Tx) High Attenuation type

Part number : FAR-F6CE-1G4410-K220

(Ta = -30 °C to +85 °C)

Parameter	Conditions	Value			Unit	Remarks
		Min.	Typ.	Max.		
Insertion loss	1429 MHz to 1453 MHz	—	2.2	3.0	dB	
Inband ripple	1429 MHz to 1453 MHz	—	1.0	2.0	dB	
Absolute attenuation	DC to 1380 MHz	25	27	—	dB	
	1477 MHz to 1501 MHz	10	18	—	dB	
	1501 MHz to 1900 MHz	30	32	—	dB	
	1900 MHz to 2906 MHz	18	28	—	dB	
Inband VSWR (Return loss)	1429 MHz to 1453 MHz	— (7.4)	2.1 (9.0)	2.5 (—)	— (dB)	

F5/F6 Series (K2 type)

24. PDC1.5 G (Rx) High Attenuation type Part number : FAR-F6CE-1G4890-K221

(Ta = -30 °C to +85 °C)

Parameter	Conditions	Value			Unit	Remarks
		Min.	Typ.	Max.		
Insertion loss	1477 MHz to 1501 MHz	—	2.5	3.0	dB	
Inband ripple	1477 MHz to 1501 MHz	—	1.0	2.0	dB	
Absolute attenuation	DC to 1429 MHz	25	28	—	dB	
	1429 MHz to 1453 MHz	10	25	—	dB	
	1542 MHz to 1566 MHz	20	28	—	dB	
	1566 MHz to 1900 MHz	30	33	—	dB	
	1900 MHz to 3000 MHz	20	29	—	dB	
Inband VSWR (Return loss)	1477 MHz to 1501 MHz	— (6.8)	2.4 (7.7)	2.7 (—)	— (dB)	

25. PDC1.5 G (Lo) Part number : FAR-F6CE-1G6190-K222

(Ta = -30 °C to +85 °C)

Parameter	Conditions	Value			Unit	Remarks
		Min.	Typ.	Max.		
Insertion loss	1607 MHz to 1631 MHz	—	2.4	3.3	dB	
Inband ripple	1607 MHz to 1631 MHz	—	1.0	2.0	dB	
Absolute attenuation	DC to 130 MHz	30	38	—	dB	
	130 MHz to 1501 MHz	25	28	—	dB	
	1737 MHz to 1809 MHz	30	35	—	dB	
	1809 MHz to 2500 MHz	25	35	—	dB	
	3214 MHz	20	30	—	dB	
Inband VSWR (Return loss)	1607 MHz to 1631 MHz	— (9.5)	1.8 (10.9)	2.0 (—)	— (dB)	

F5/F6 Series (K2 type)

TYPICAL CHARACTERISTICS

1. AMPS/TDMA/CDMA (Tx) Low Loss type Part number : FAR-F5CE-836M50-K225

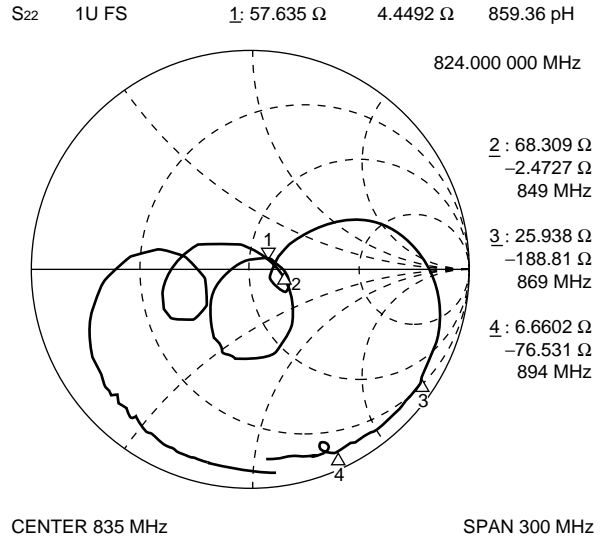
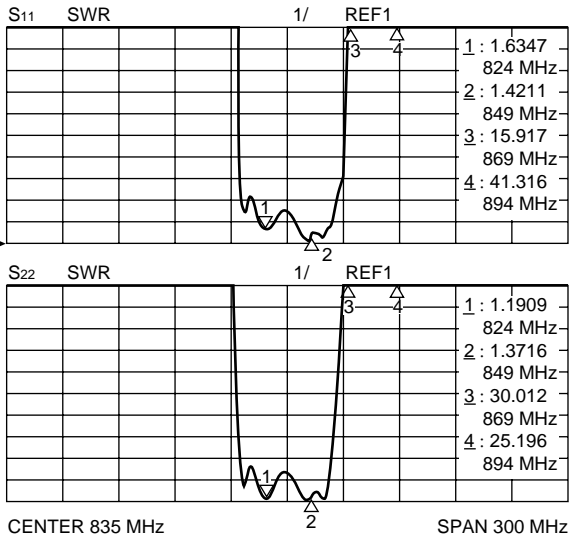
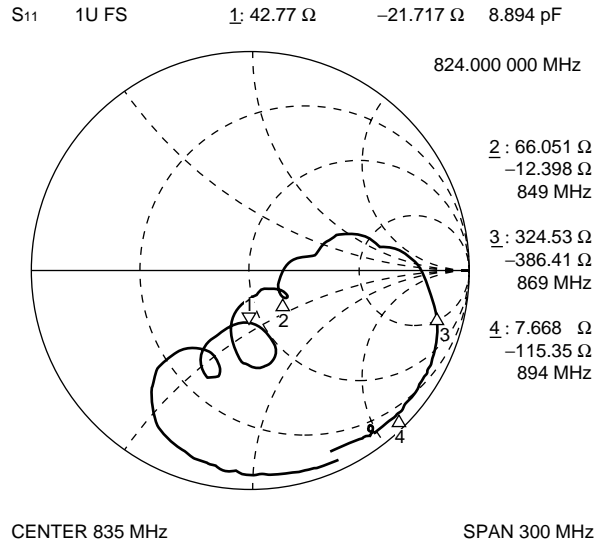
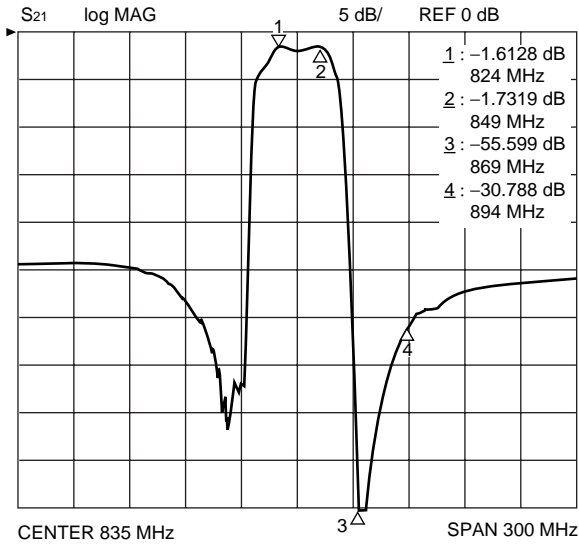

F5/F6 Series (K2 type)

2. AMPS/TDMA/CDMA (Tx) High Attenuation type Part number : FAR-F5CE-836M50-K230

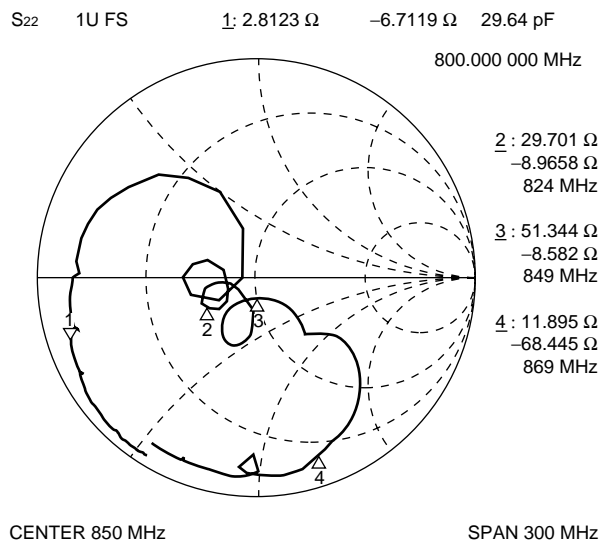
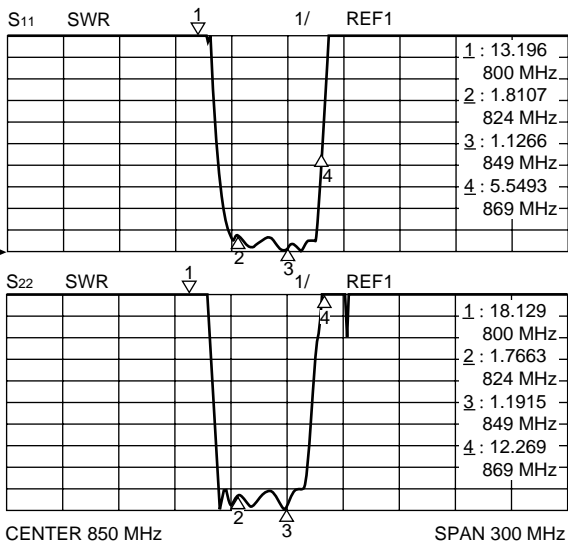
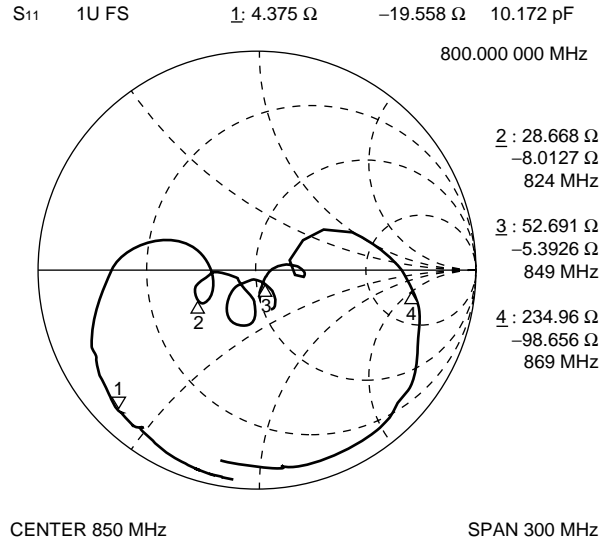
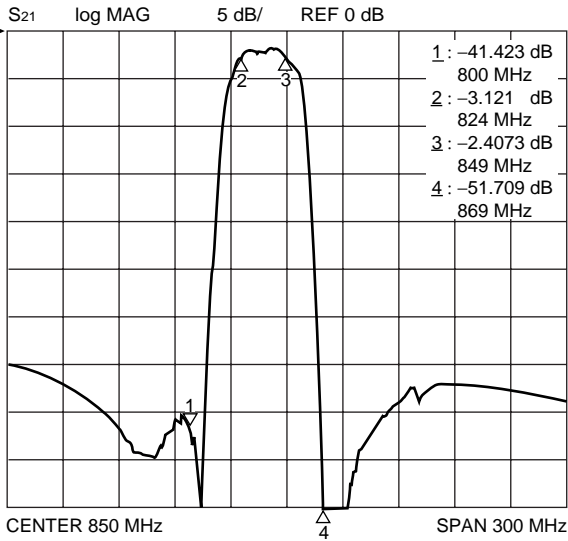

F5/F6 Series (K2 type)

3. AMPS/TDMA/CDMA (Tx) Low Loss type Part number : FAR-F5CE-836M50-K236

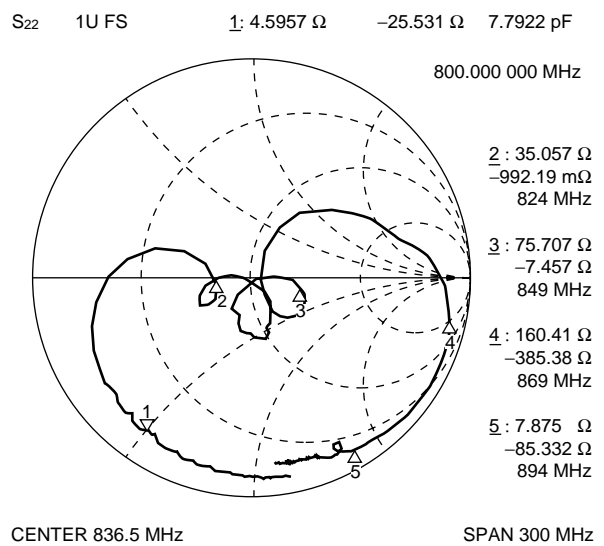
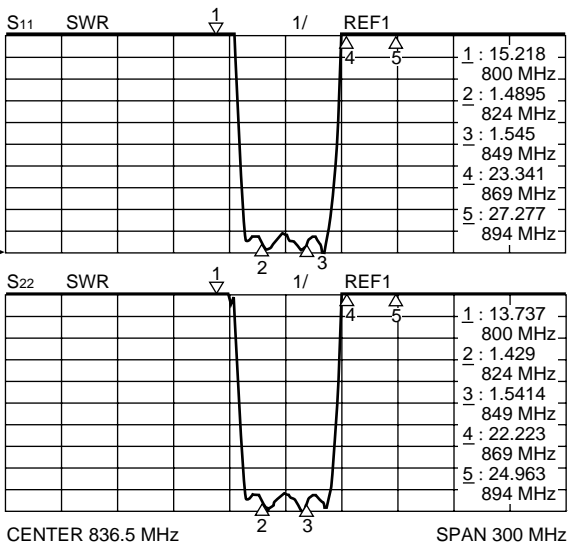
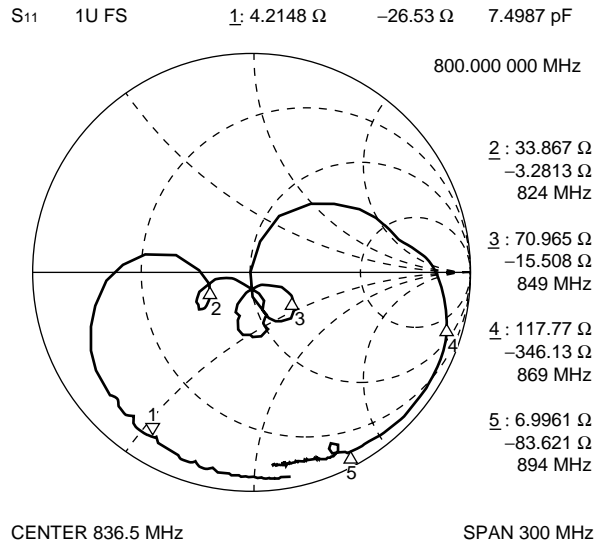
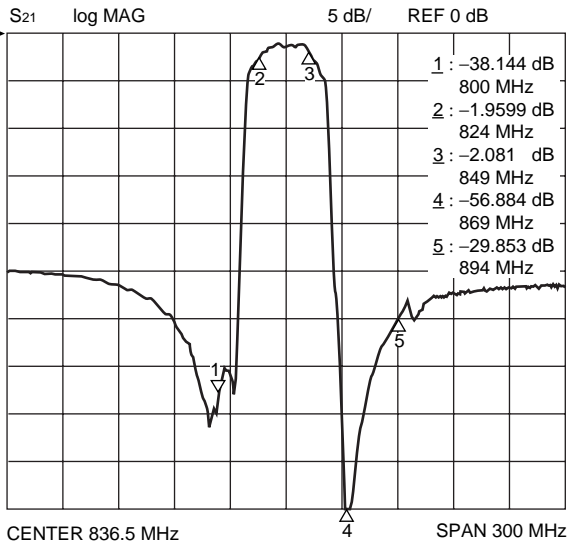

F5/F6 Series (K2 type)

4. AMPS/TDMA/CDMA (Tx) High Attenuation type Part number : FAR-F5CE-836M50-K289

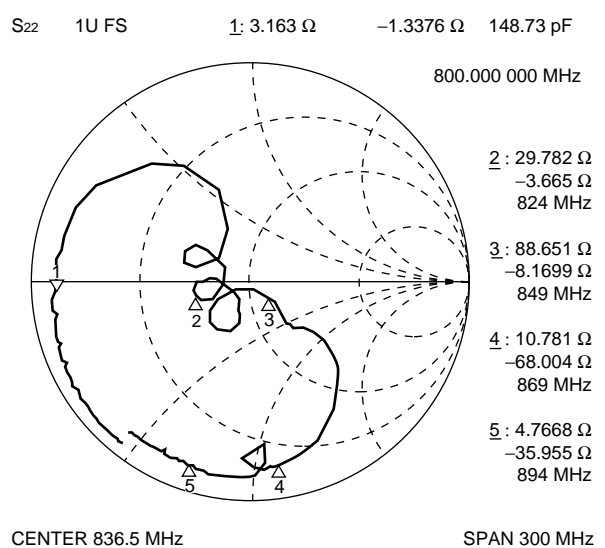
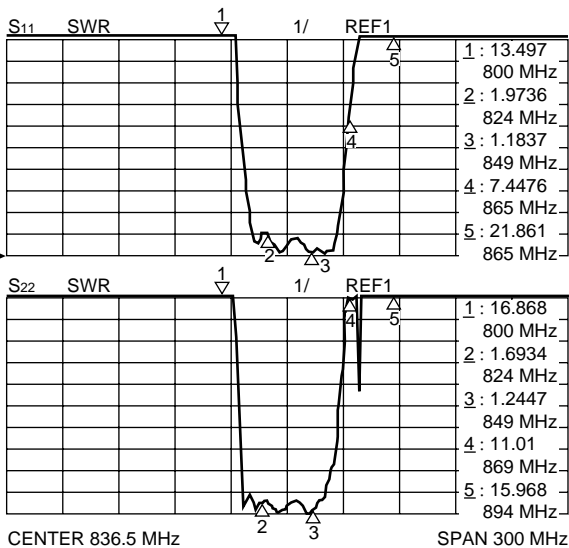
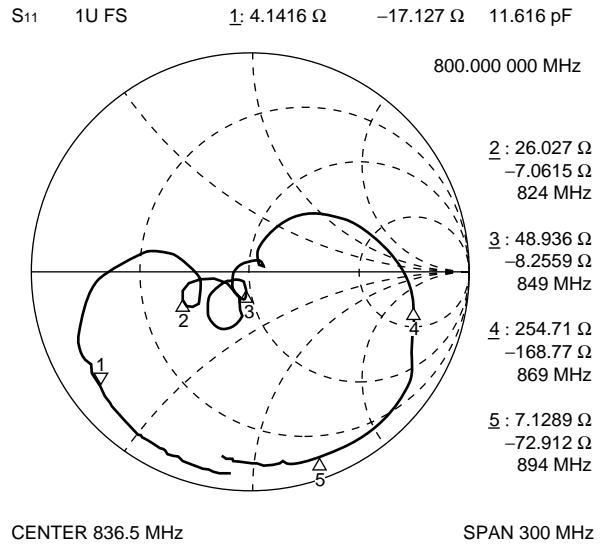
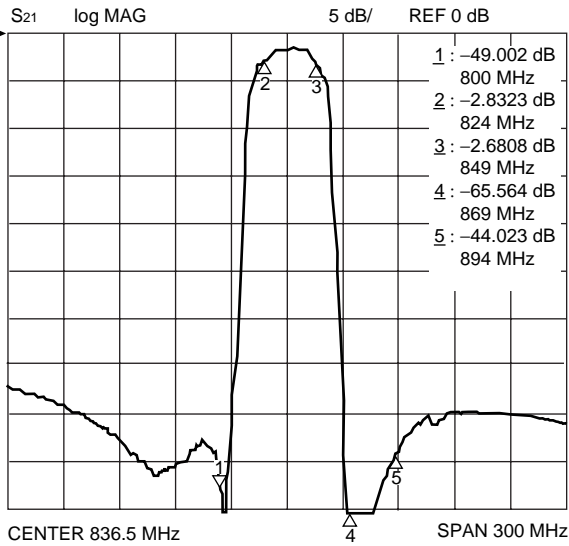

F5/F6 Series (K2 type)

5. AMPS/TDMA/CDMA (Rx) Low Loss type Part number : FAR-F5CE-881M50-K235

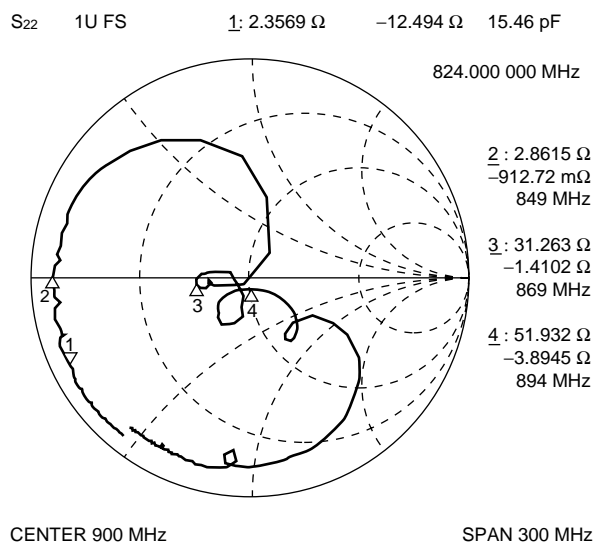
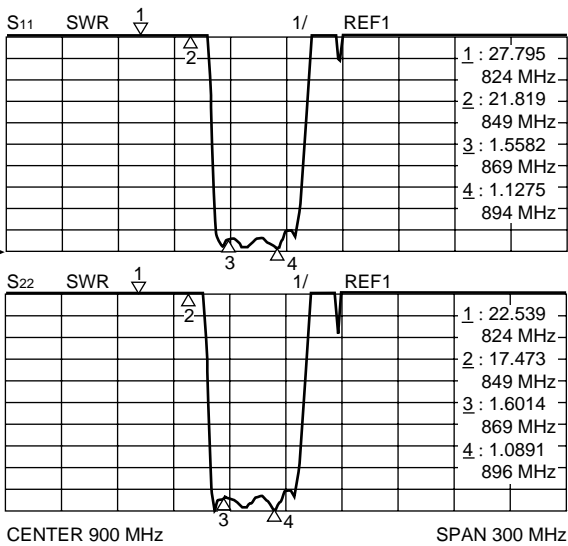
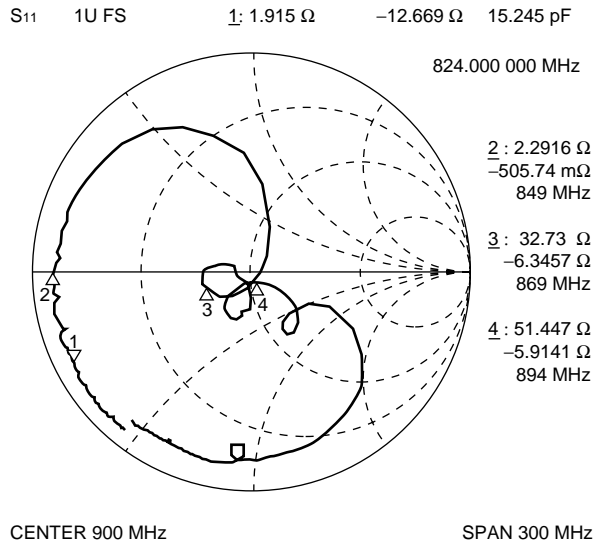
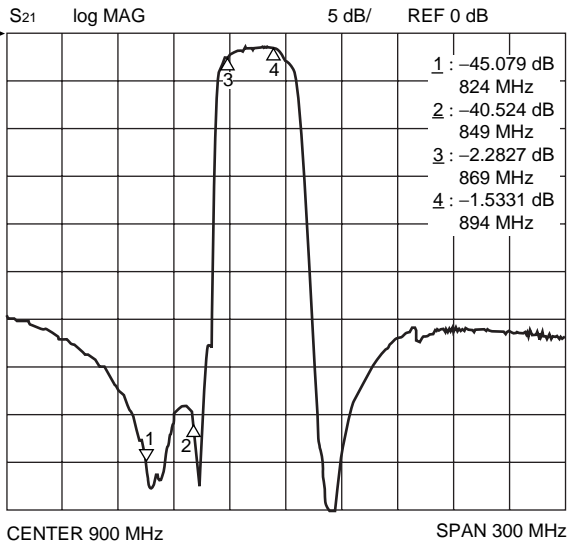

F5/F6 Series (K2 type)

6. AMPS/TDMA/CDMA (Rx) High Attenuation type Part number : FAR-F5CE-881M50-K210

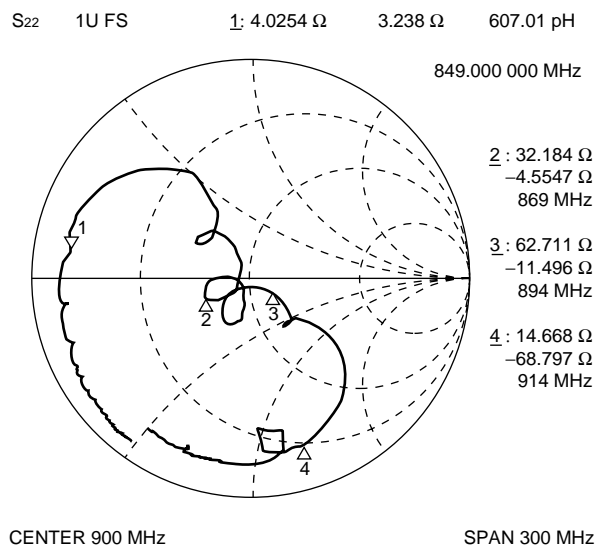
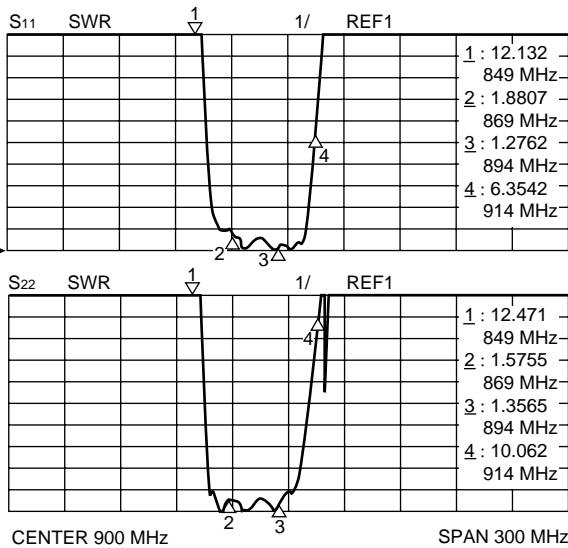
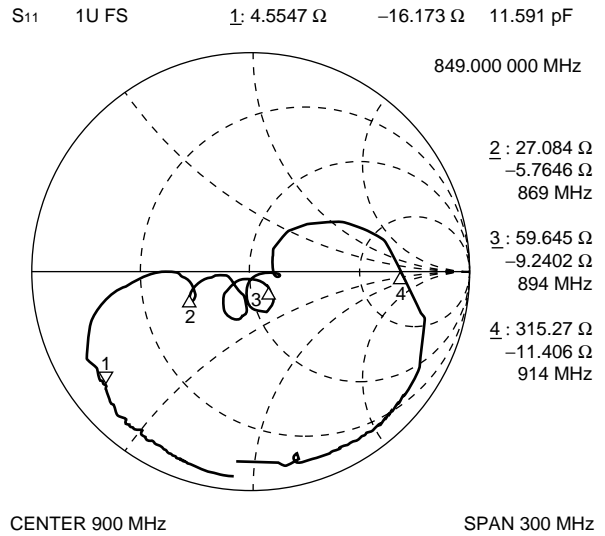
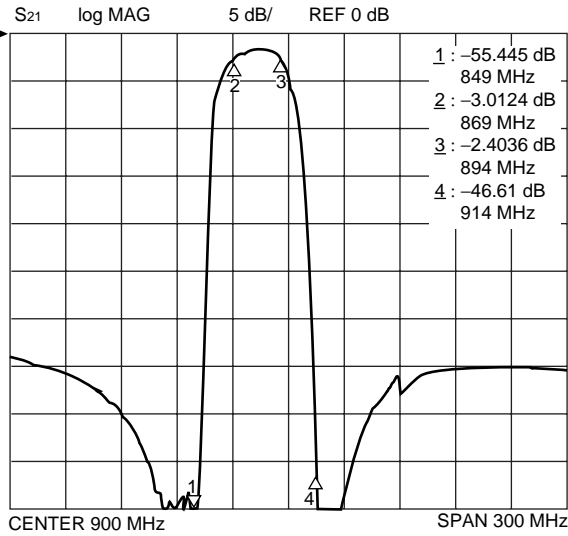

F5/F6 Series (K2 type)

7. GSM (Tx)

Part number : FAR-F5CE-902M50-K213

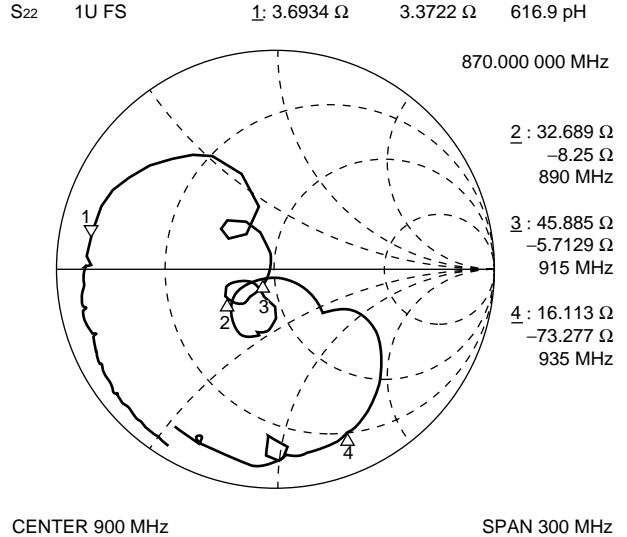
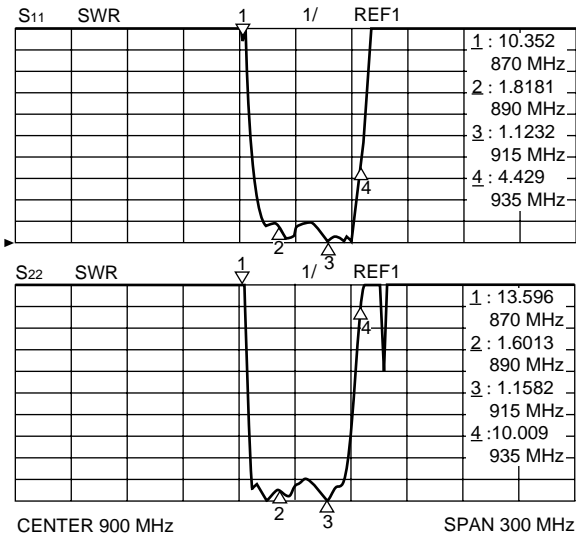
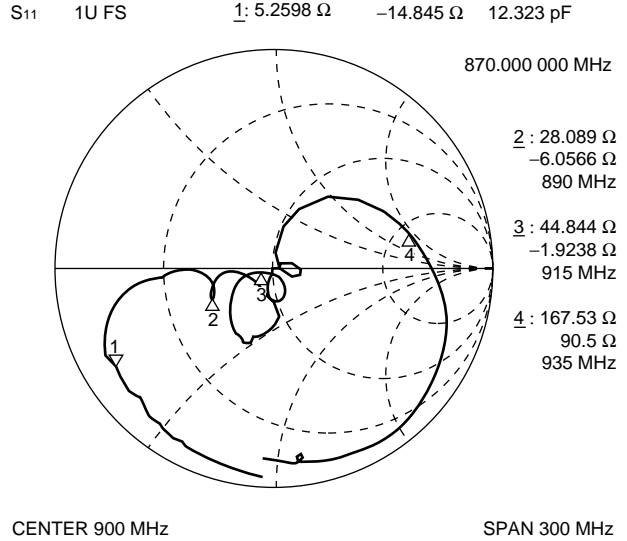
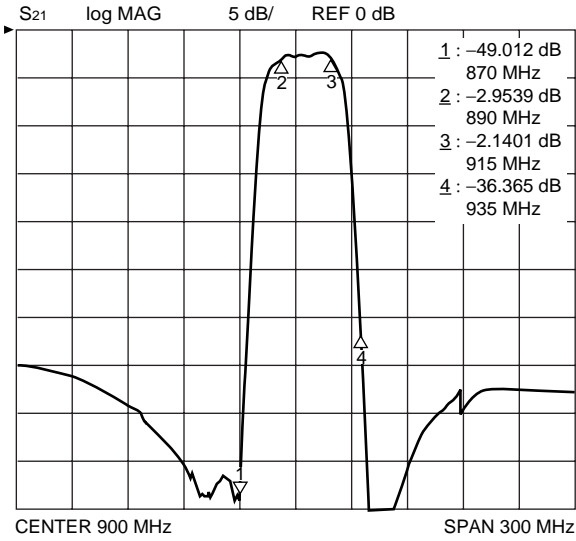

F5/F6 Series (K2 type)

8. GSM (Rx) Ultra Low Loss type Part number : FAR-F5CE-947M50-K233

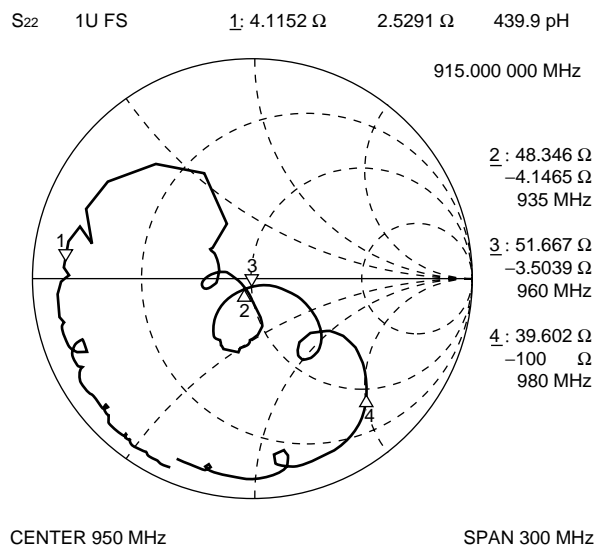
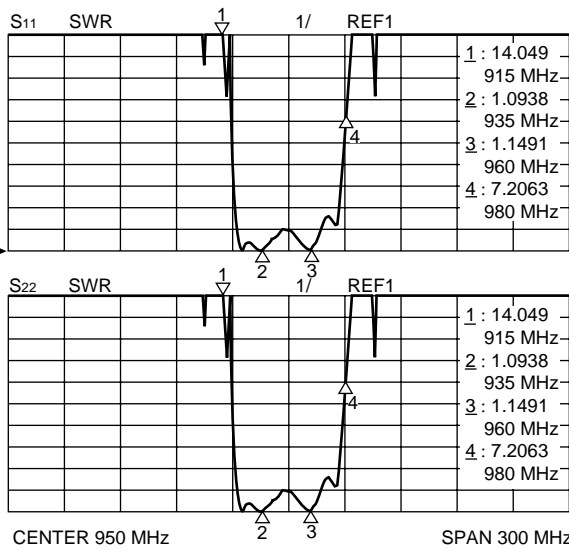
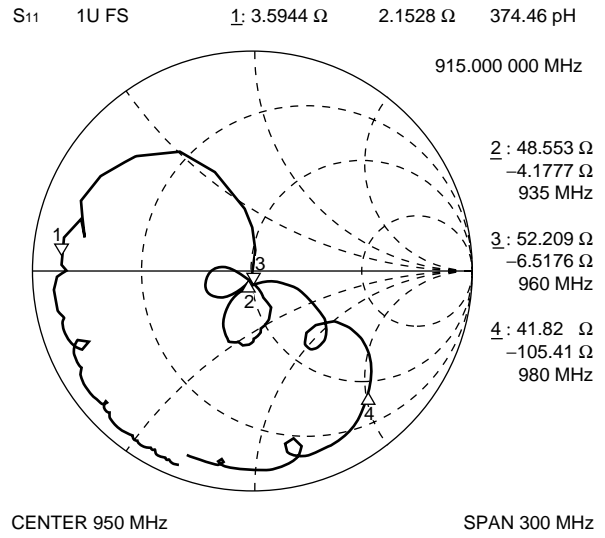
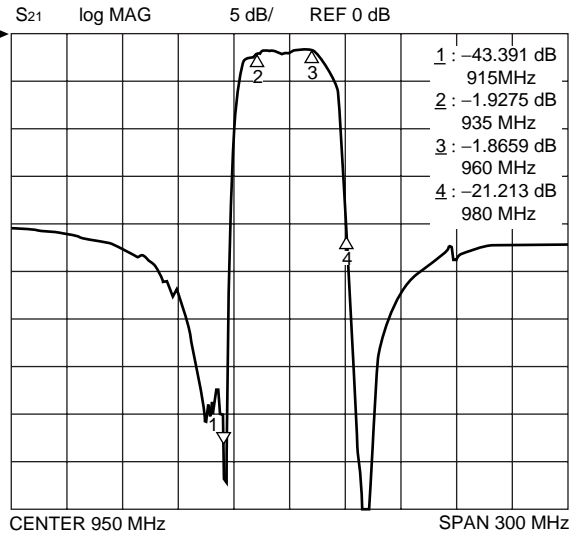

F5/F6 Series (K2 type)

9. GSM (Rx) Low Loss type Part number : FAR-F5CE-947M50-K214

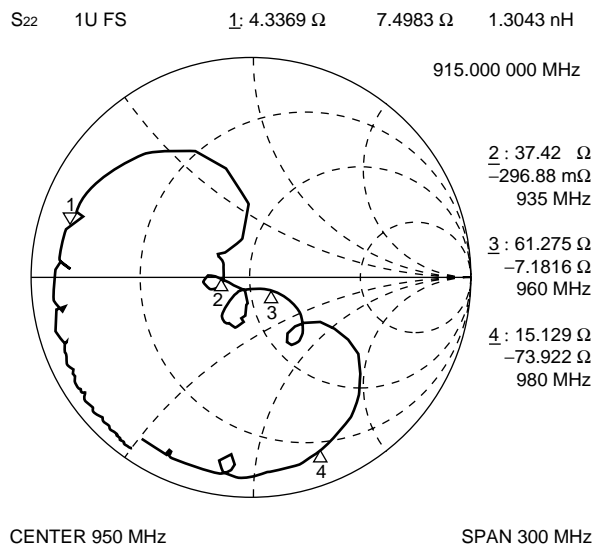
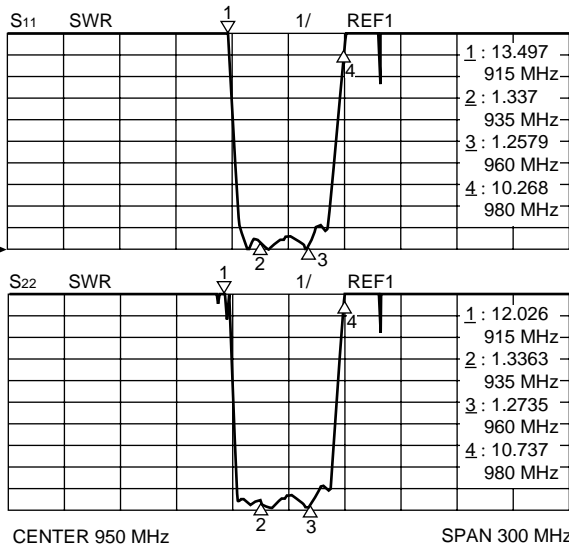
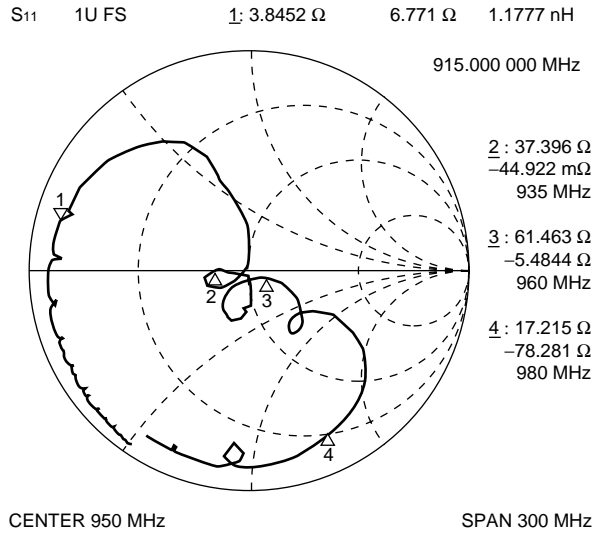
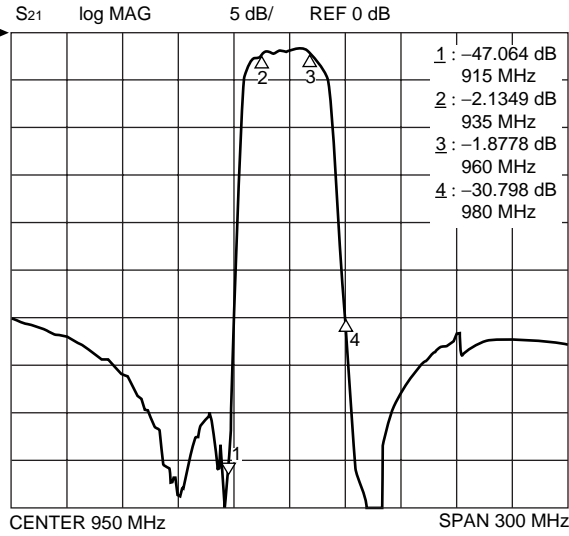

F5/F6 Series (K2 type)

10. GSM (Rx) High Attenuation type Part number : FAR-F5CE-947M50-K228

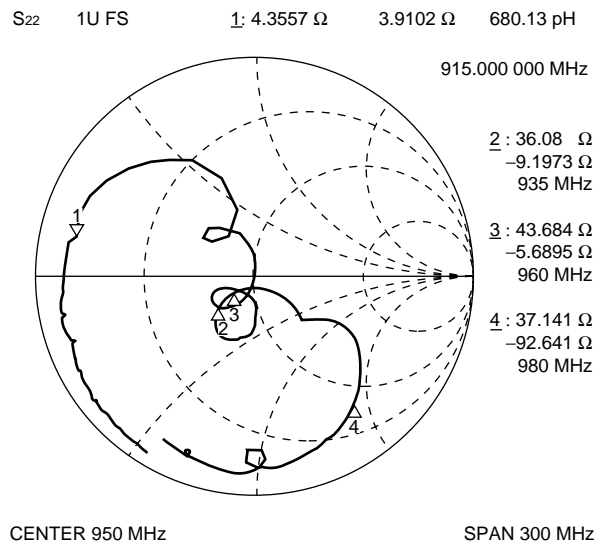
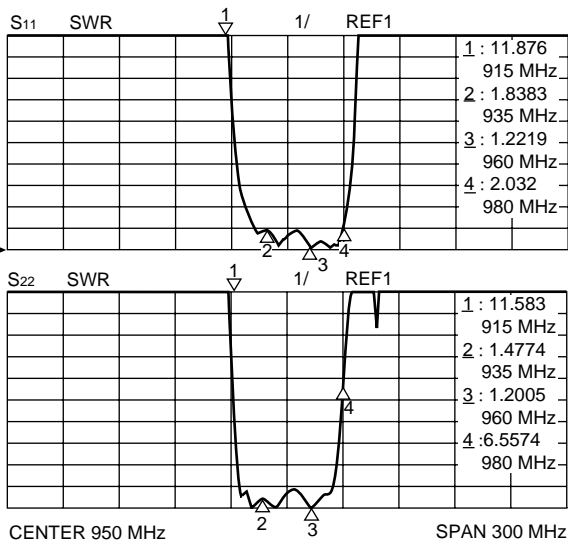
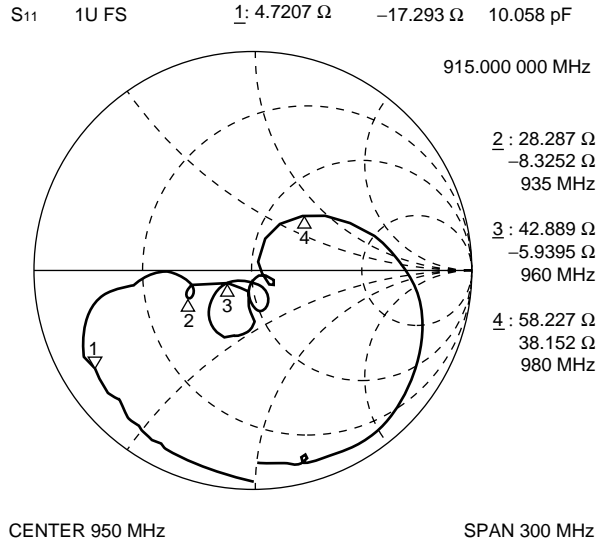
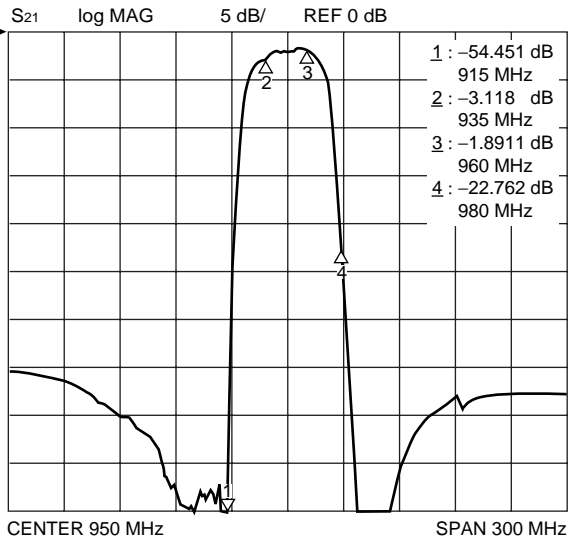

F5/F6 Series (K2 type)

11. EGSM (Tx)

Part number : FAR-F5CE-897M50-K226

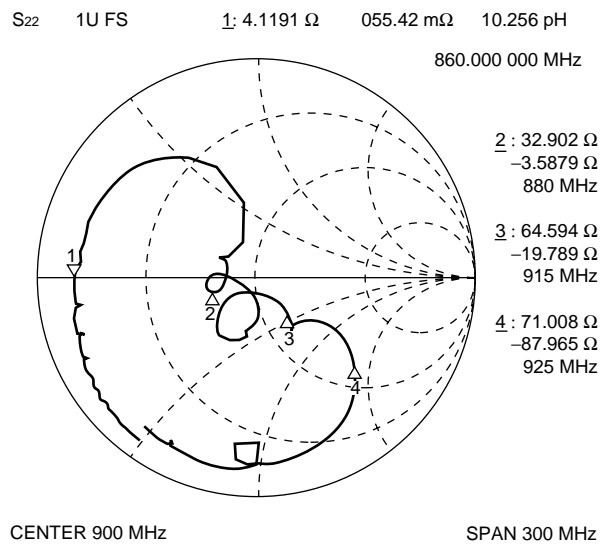
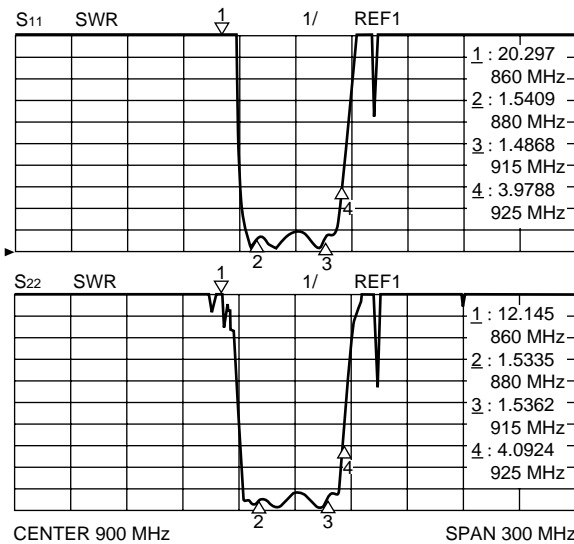
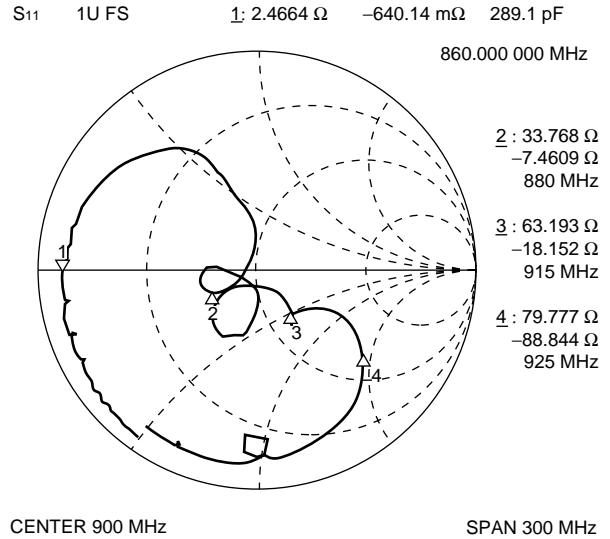
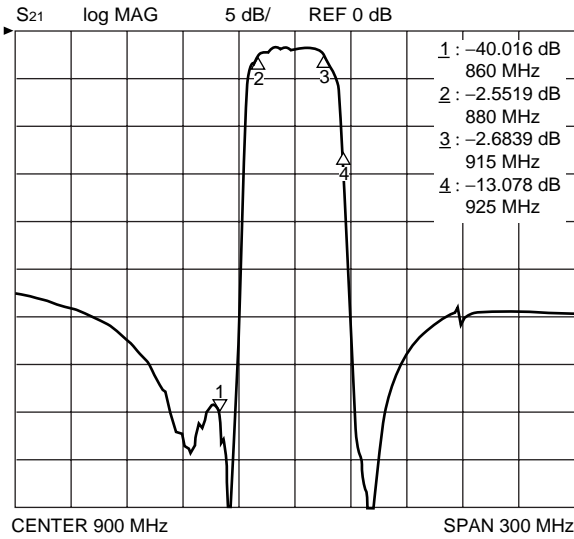

F5/F6 Series (K2 type)

12. EGSM (Tx) Low Loss type

Part number : FAR-F5CE-897M50-K231

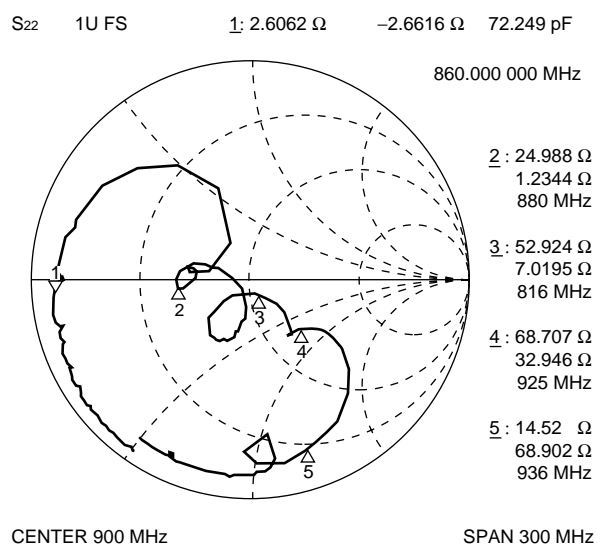
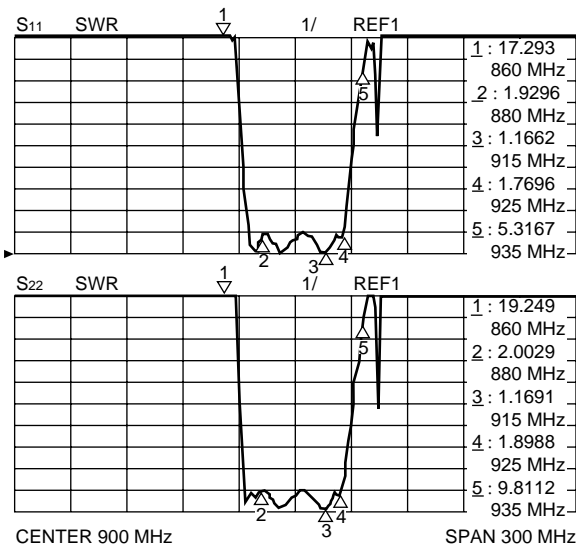
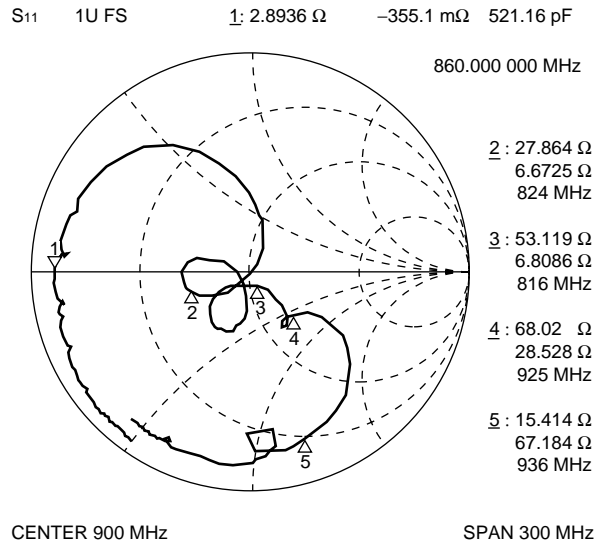
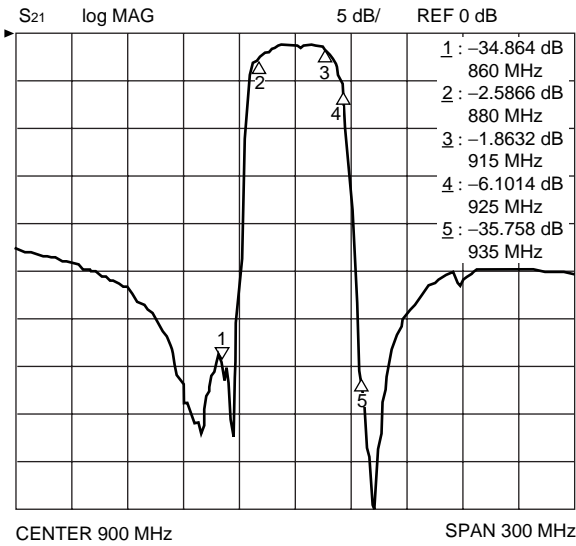

F5/F6 Series (K2 type)

13. EGSM (Rx) Low Loss type Part number : FAR-F5CE-942M50-K288

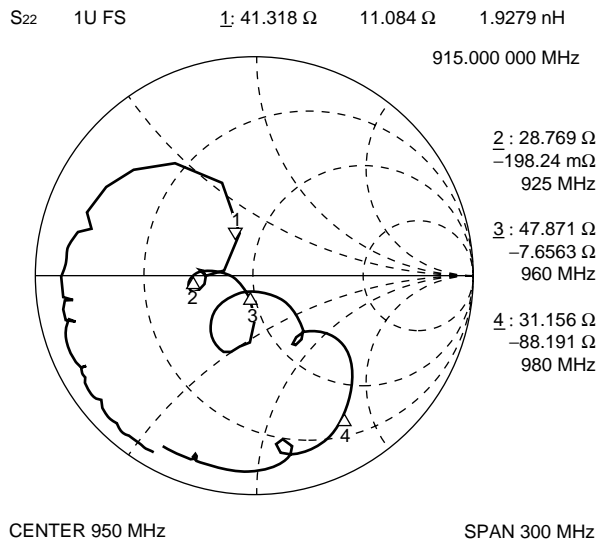
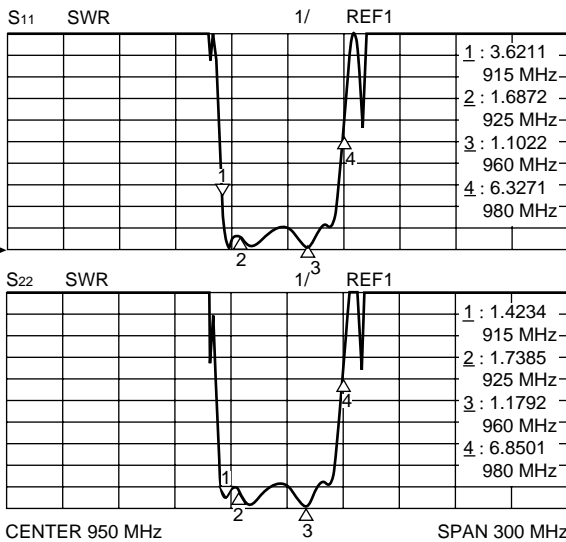
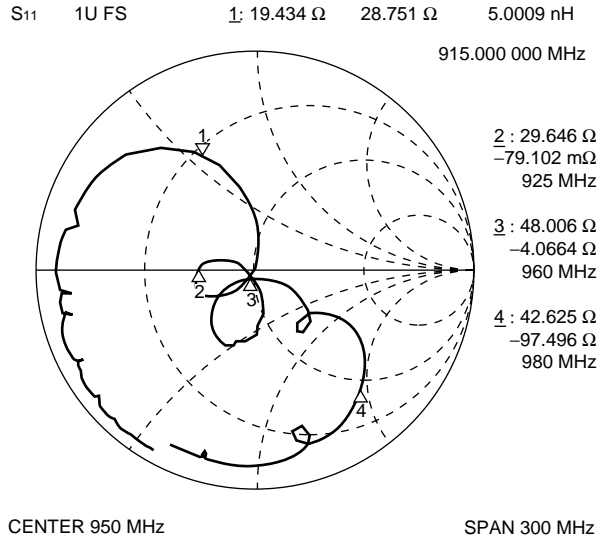
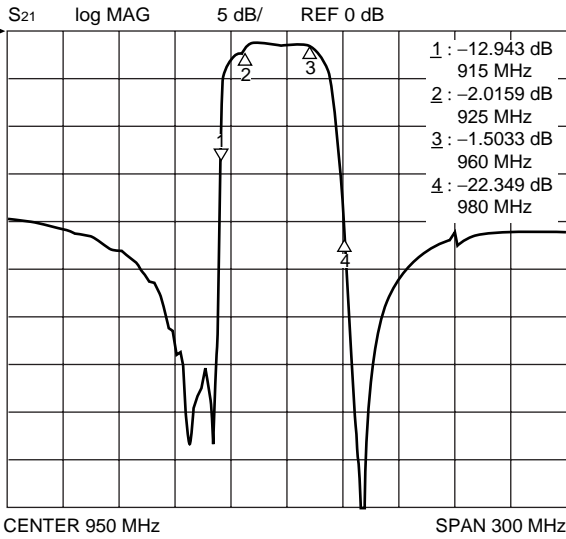

F5/F6 Series (K2 type)

14. EGSM (Rx)

Part number : FAR-F5CE-942M50-K237

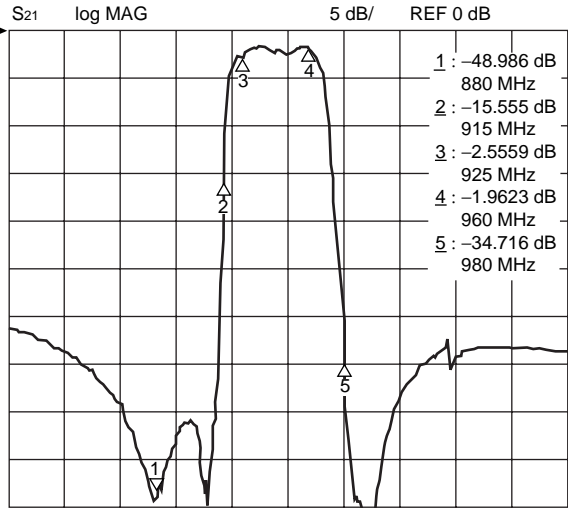

CENTER 950 MHz

SPAN 300 MHz

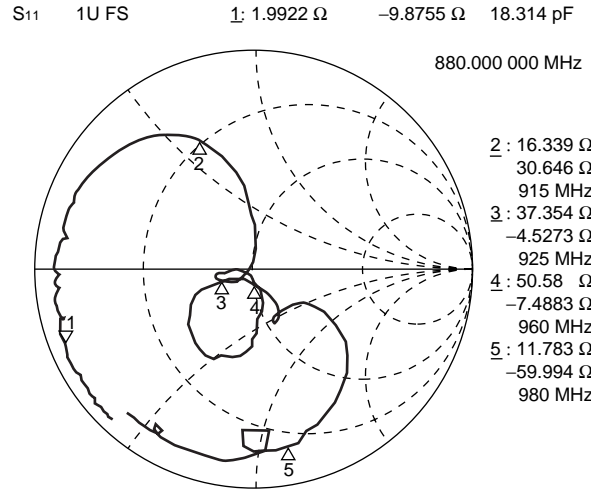

CENTER 950 MHz

SPAN 300 MHz

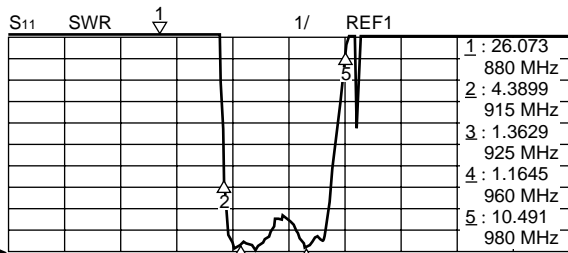

CENTER 950 MHz

SPAN 300 MHz

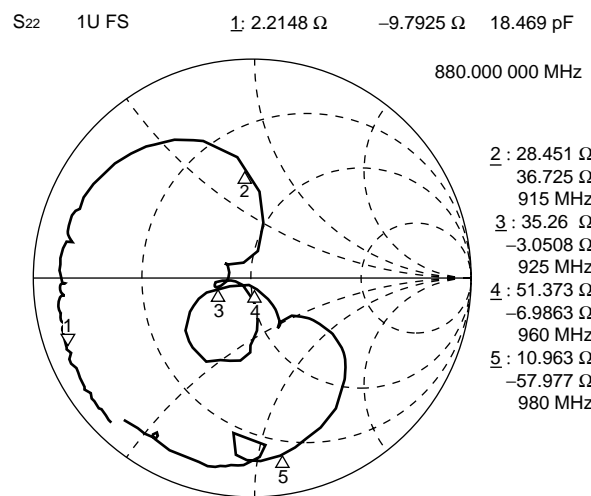

CENTER 950 MHz

SPAN 300 MHz

F5/F6 Series (K2 type)

15. PDC800 (Tx)

Part number : FAR-F5CE-950M00-K201

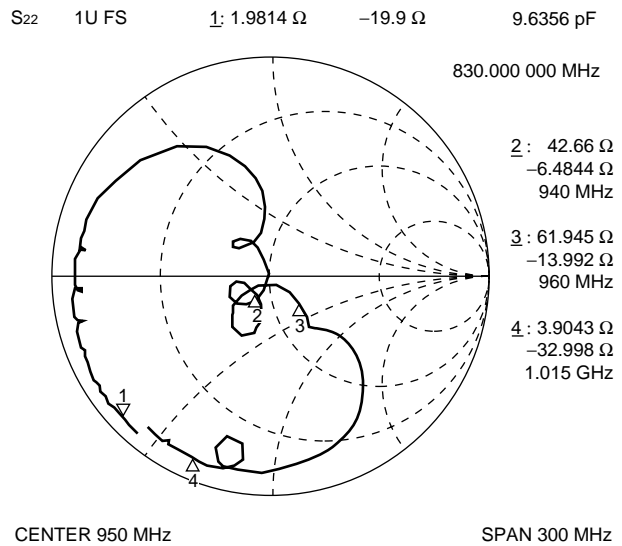
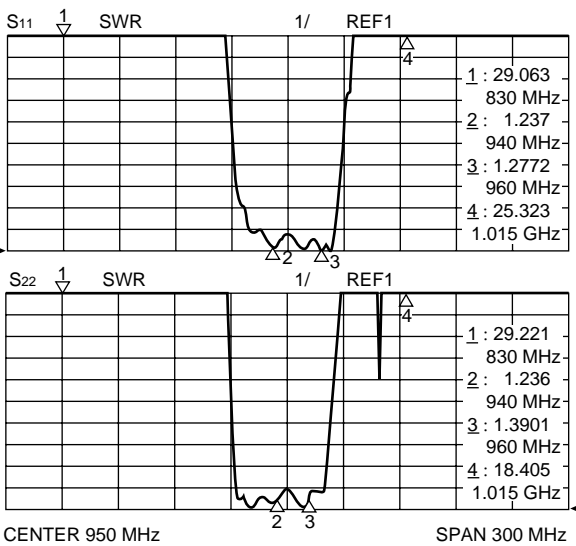
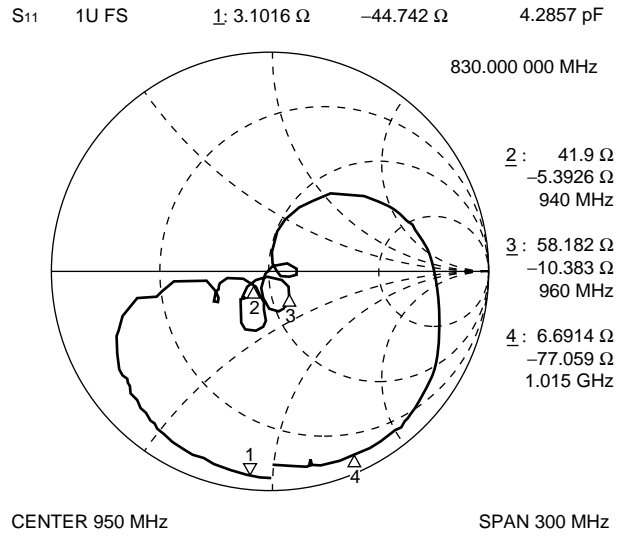
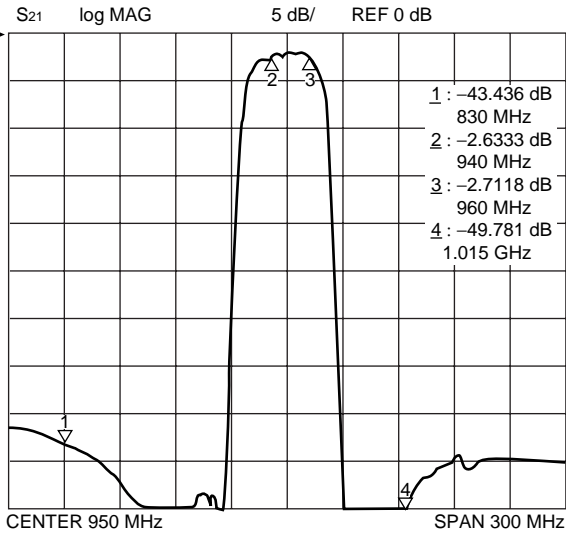

F5/F6 Series (K2 type)

16. PDC800 (Rx) Low Loss type Part number : FAR-F5CE-820M00-K202

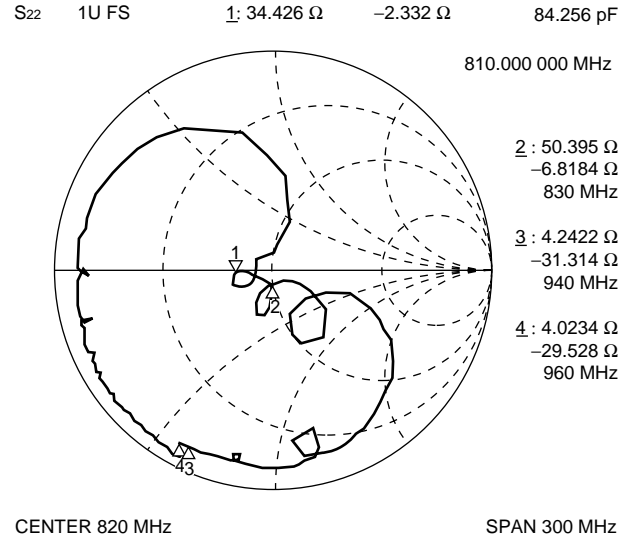
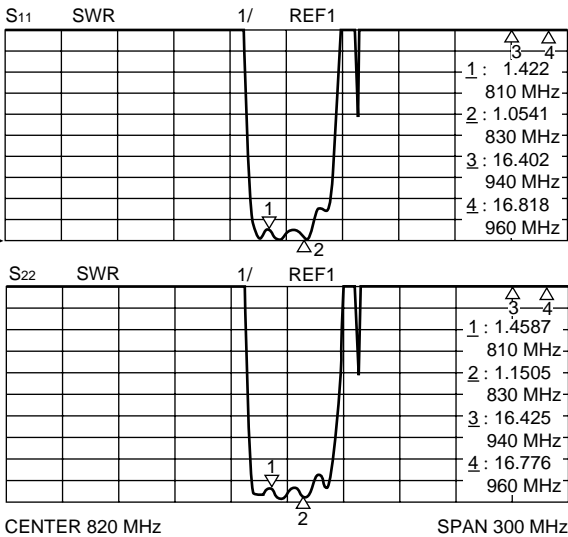
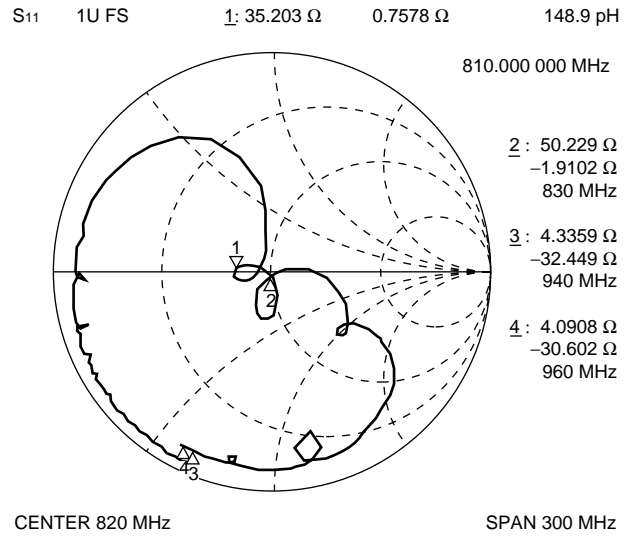
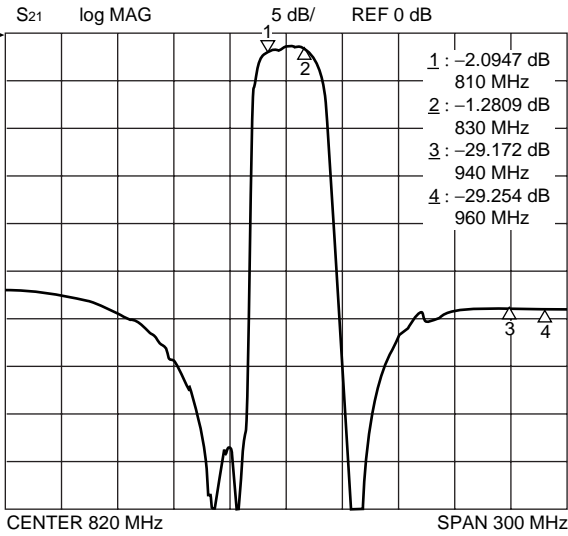

F5/F6 Series (K2 type)

17. PDC800 (Rx) High Attenuation type Part number : FAR-F5CE-820M00-K204

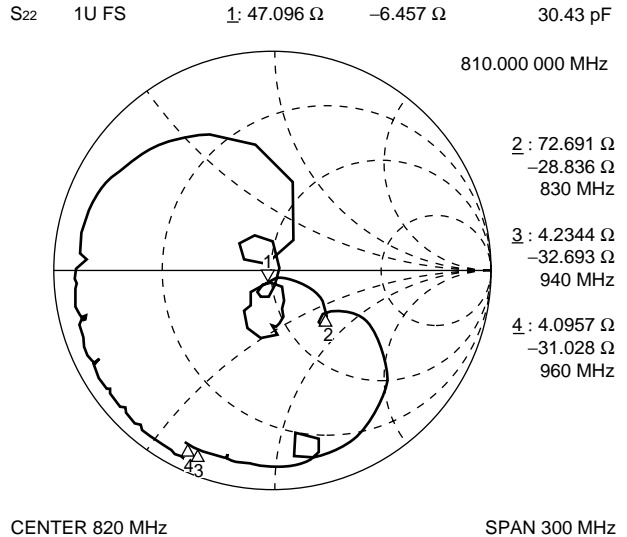
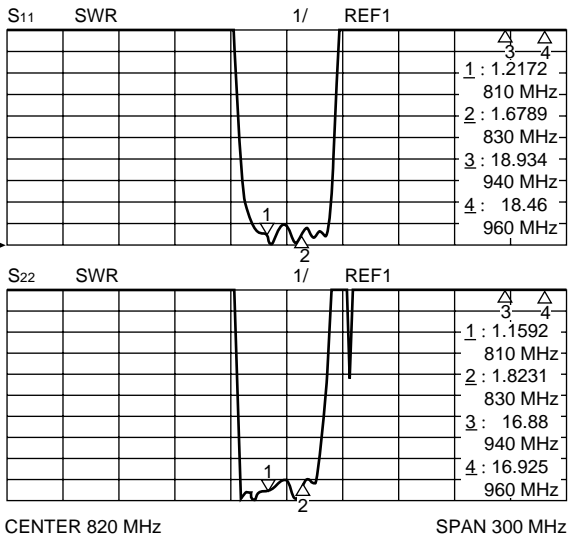
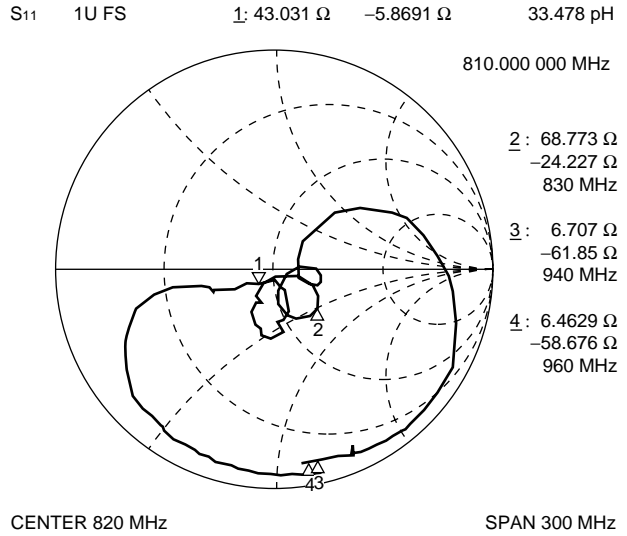
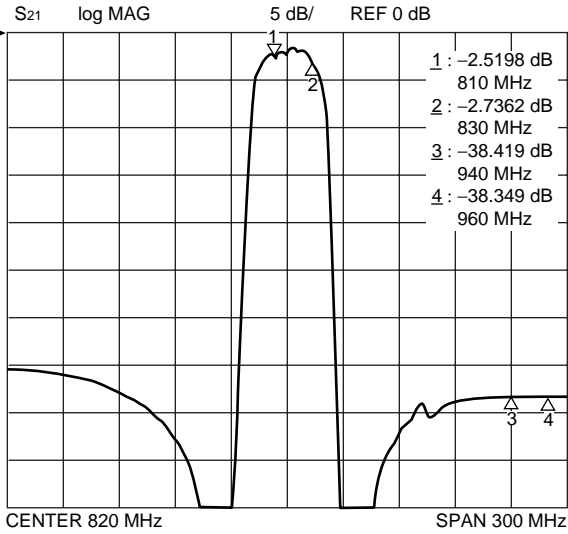

F5/F6 Series (K2 type)

18. J-CDMA (Tx) Low Loss type Part number : FAR-F5CE-906M00-K211

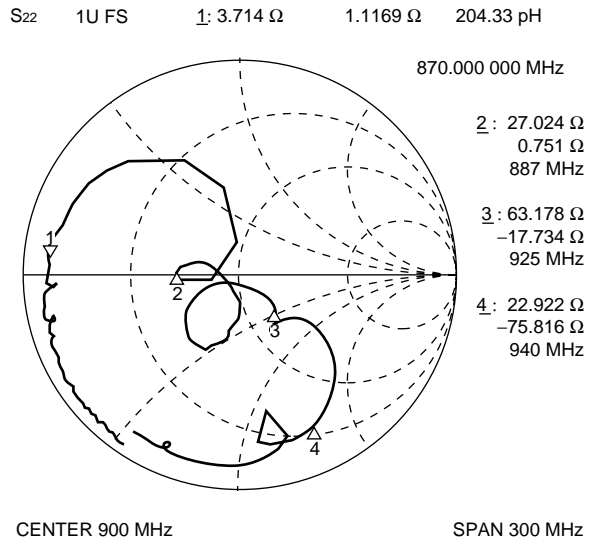
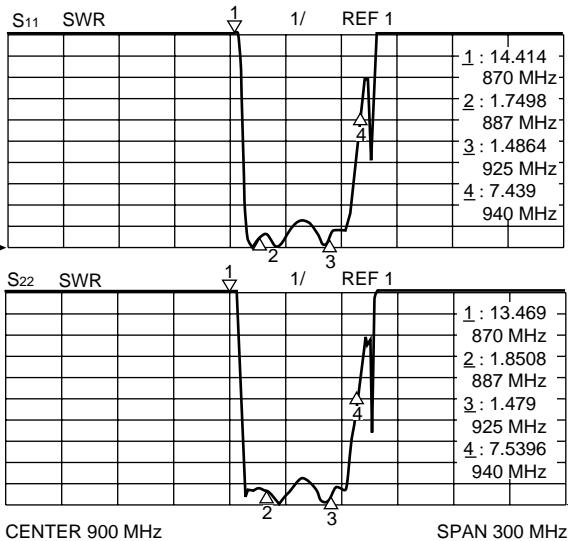
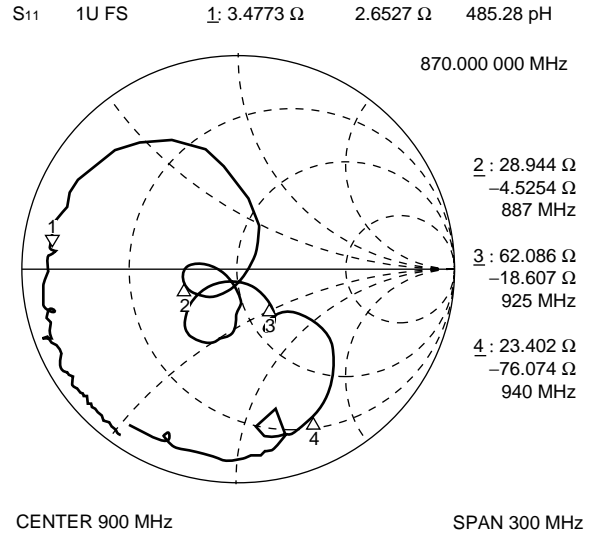
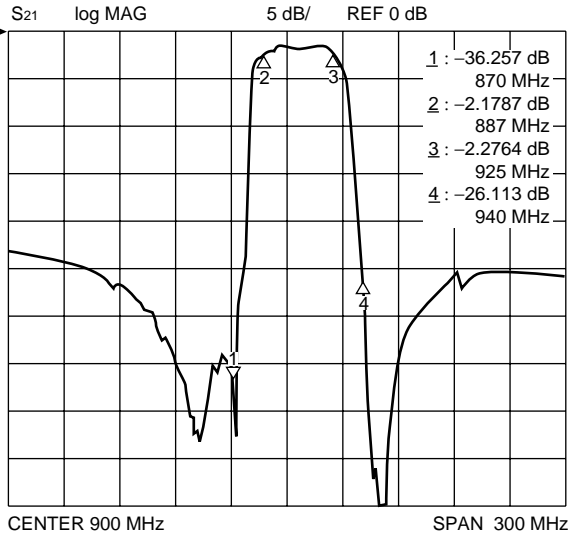

F5/F6 Series (K2 type)

19. J-CDMA (Tx)

Part number : FAR-F5CE-906M00-K219

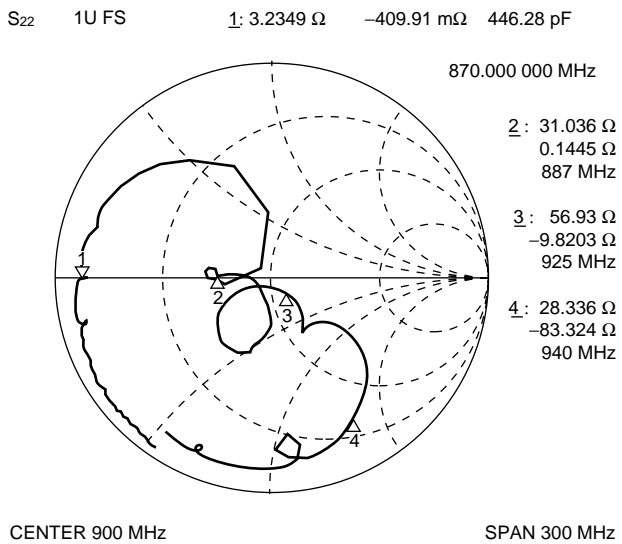
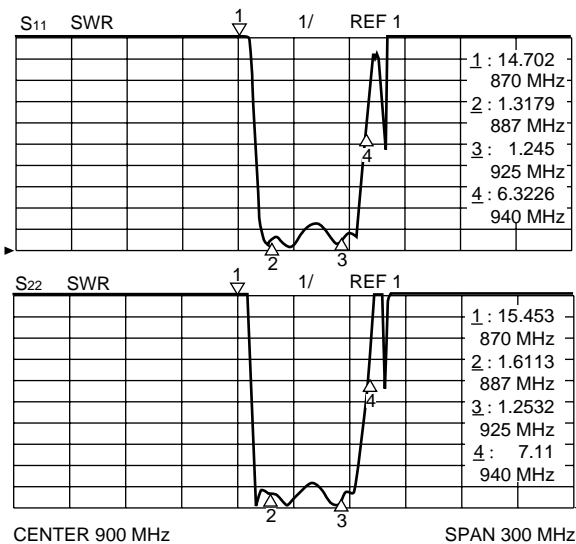
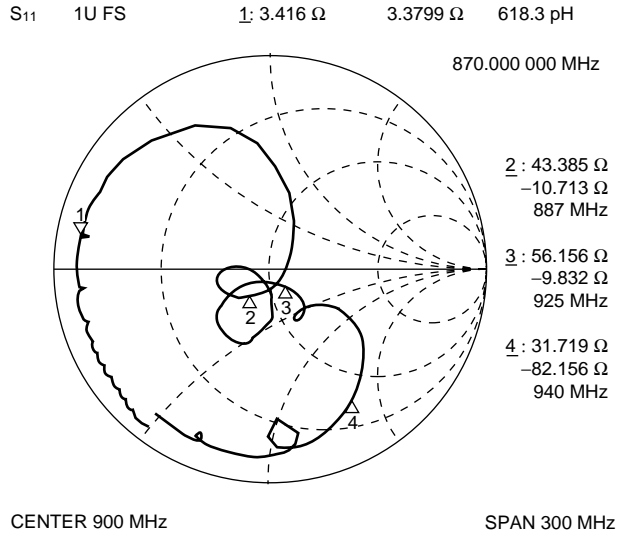
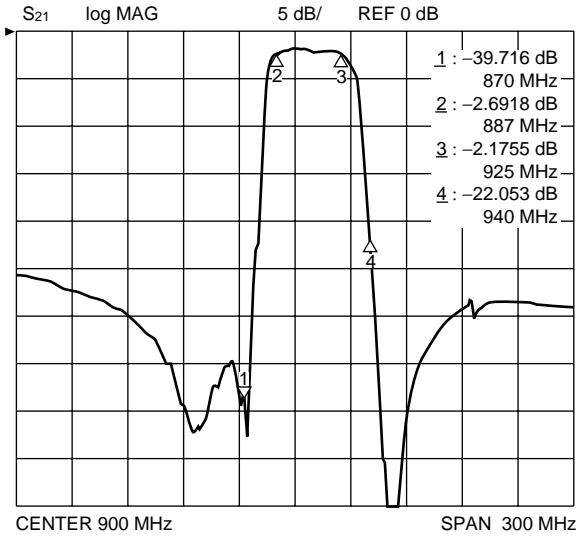

F5/F6 Series (K2 type)

20. J-CDMA (Tx) High Attenuation type Part number : FAR-F5CE-906M00-K215

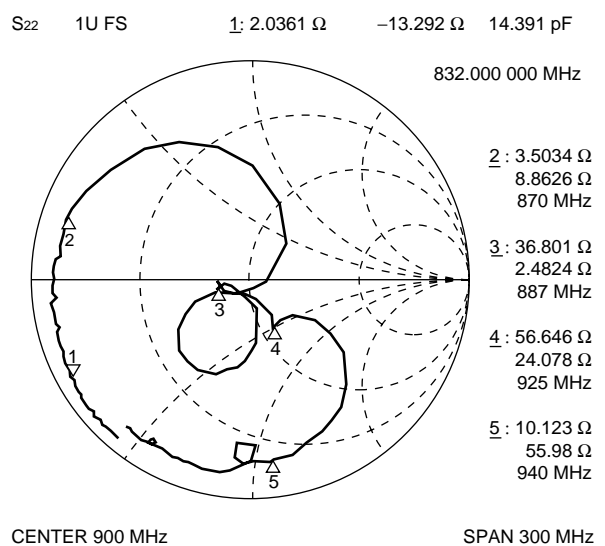
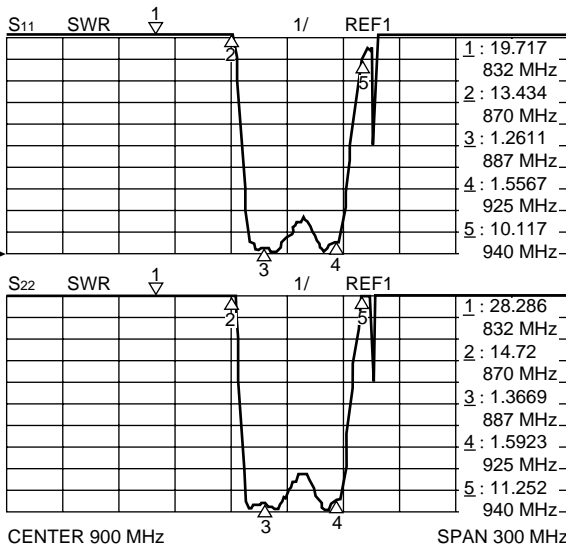
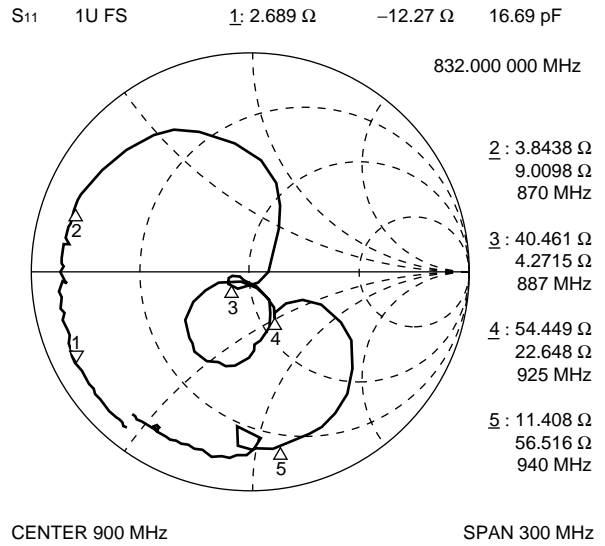
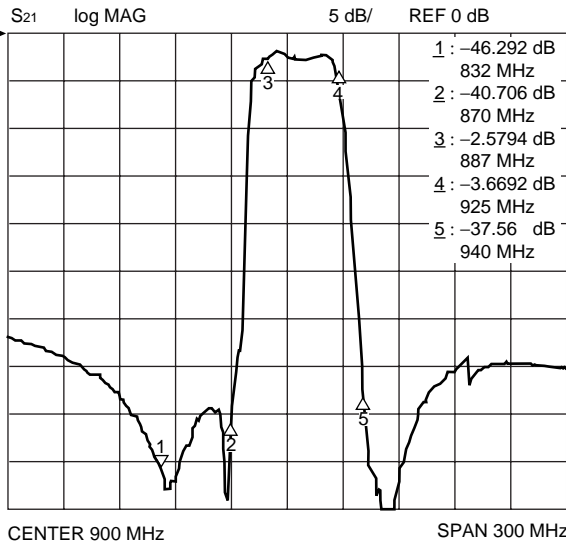

F5/F6 Series (K2 type)

21. J-CDMA (Tx)

Part number : FAR-F5CE-906M00-K238

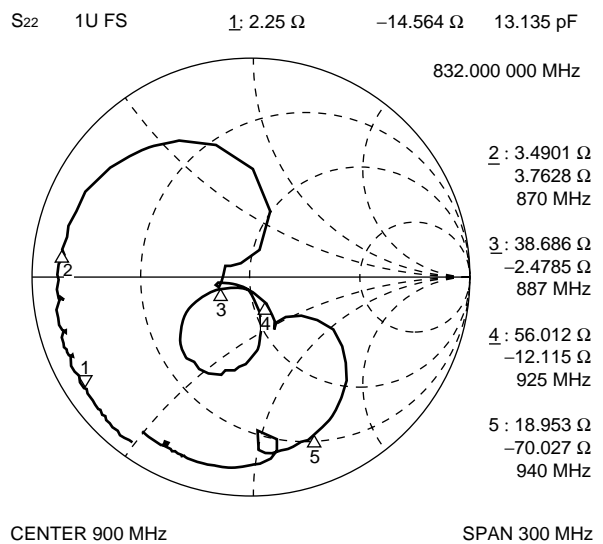
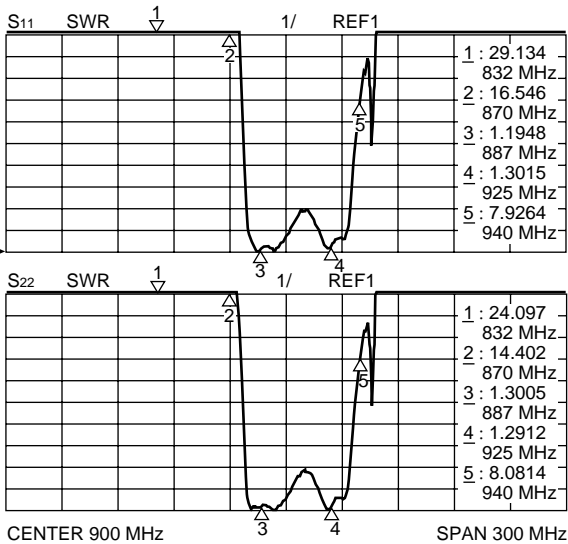
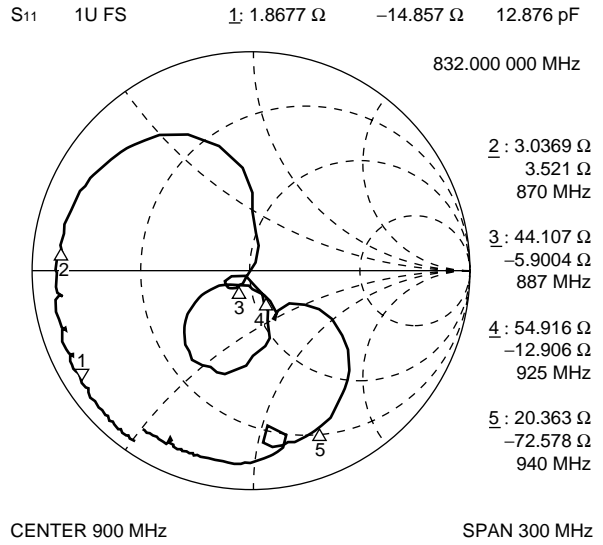
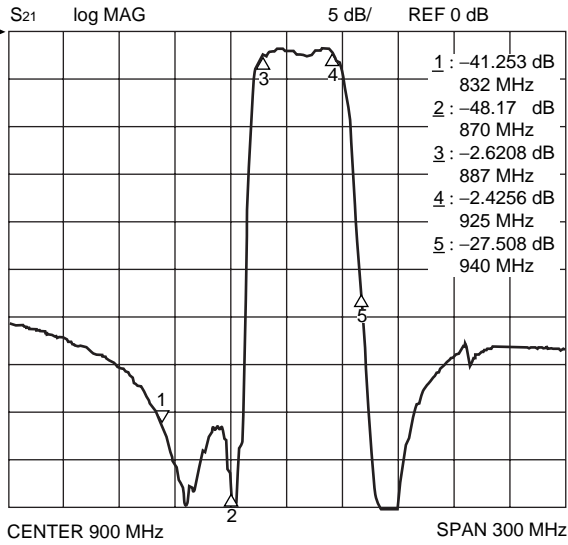

F5/F6 Series (K2 type)

22. J-CDMA (Rx)

Part number : FAR-F5CE-851M00-K212

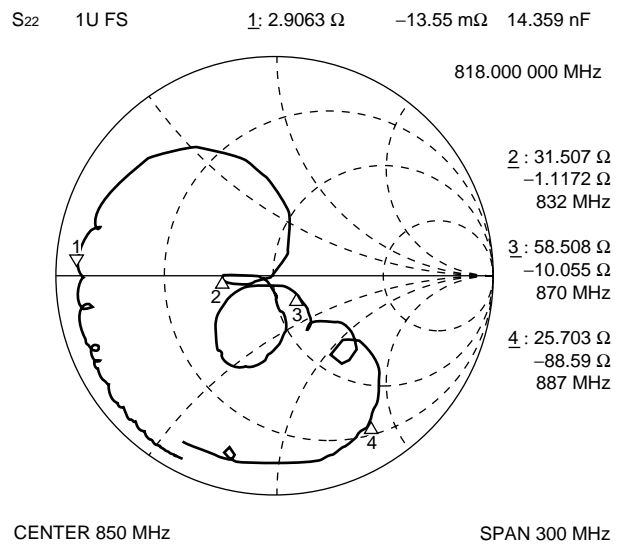
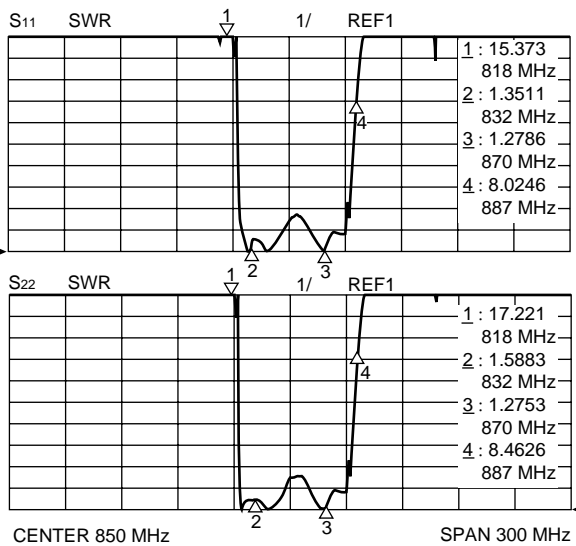
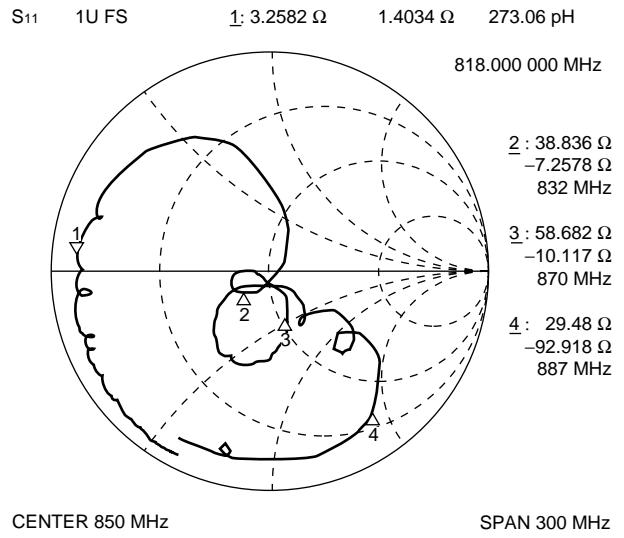
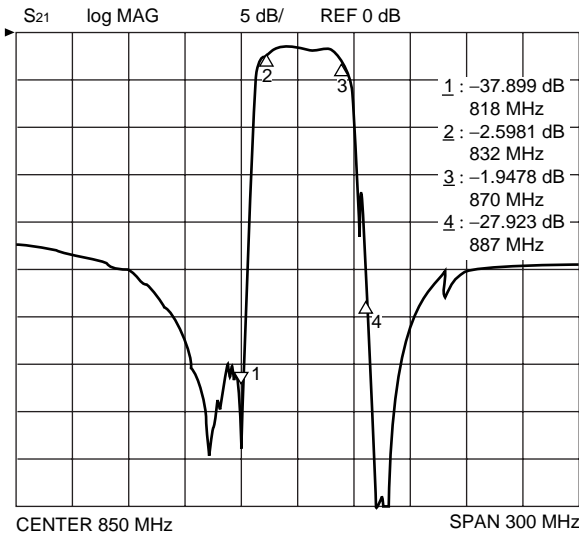

F5/F6 Series (K2 type)

23. PDC1.5 G (Tx) High Attenuation type Part number : FAR-F6CE-1G4410-K220

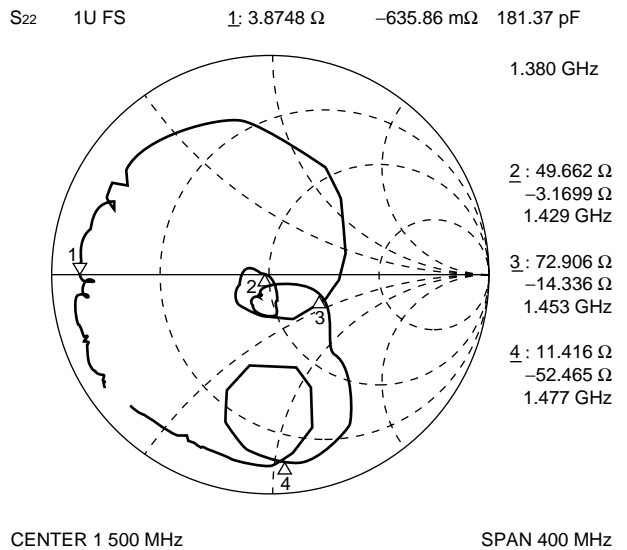
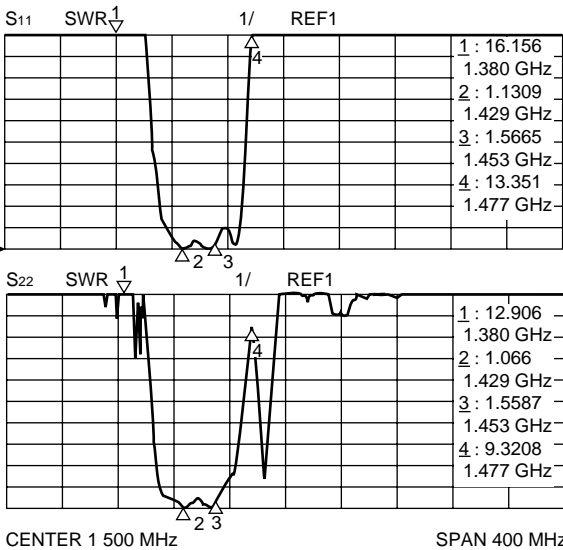
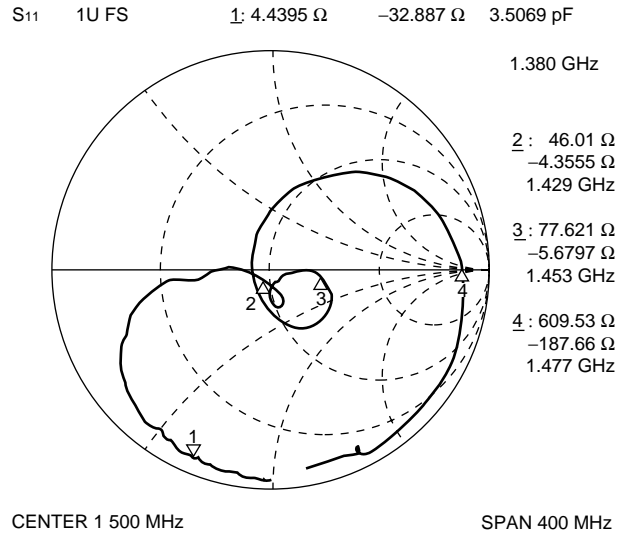
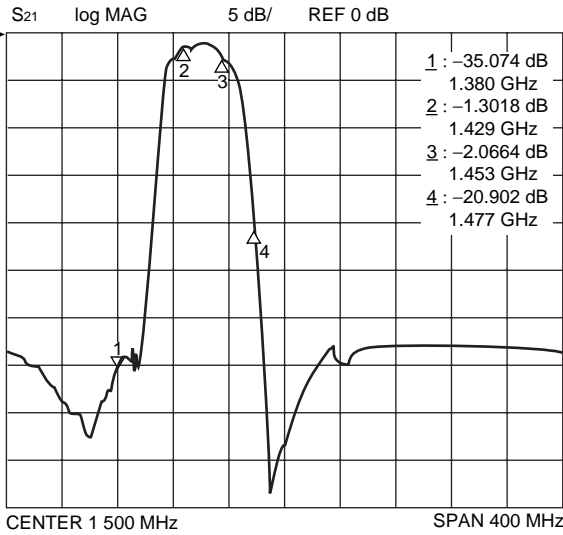

F5/F6 Series (K2 type)

24. PDC1.5 G (Rx) High Attenuation type Part number : FAR-F6CE-1G4890-K221

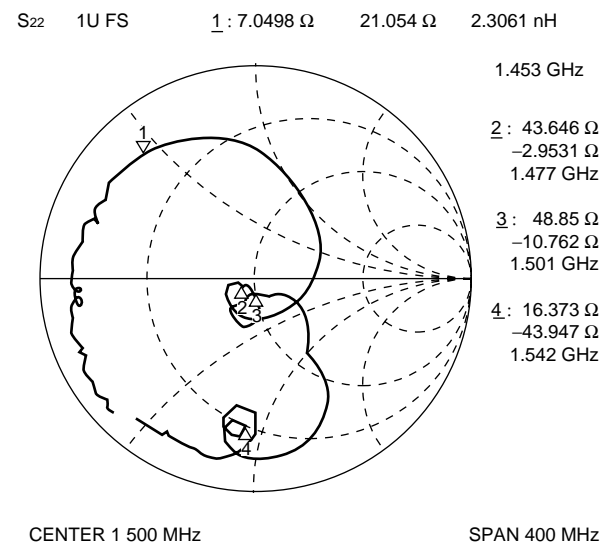
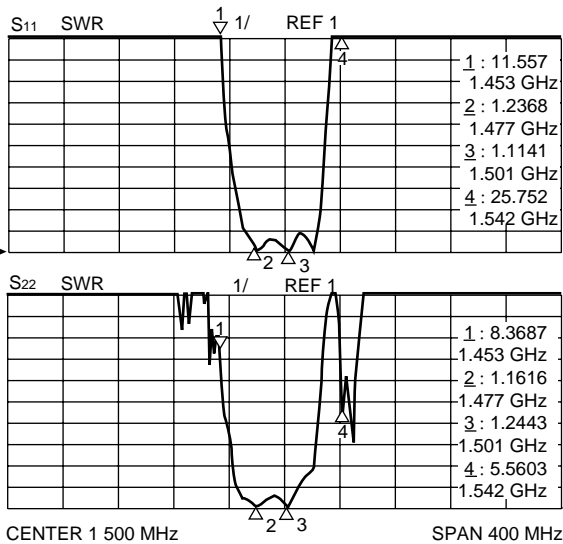
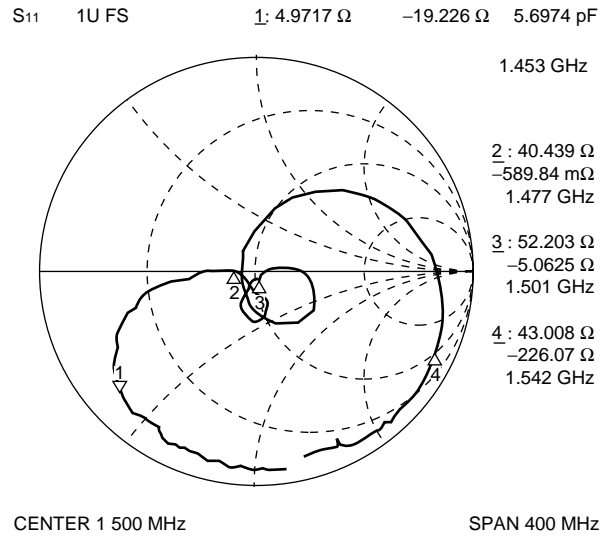
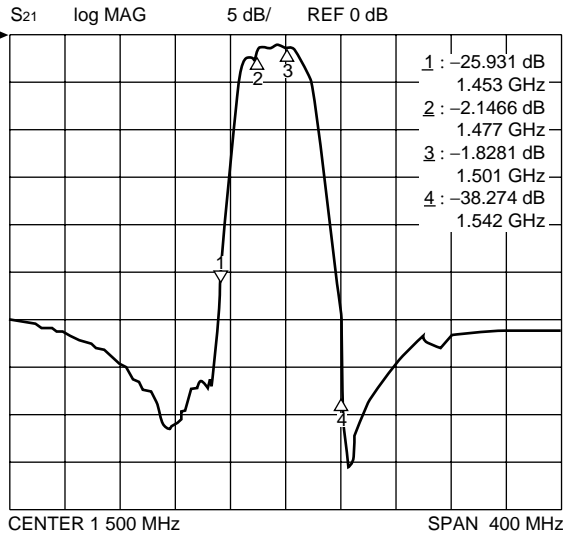

F5/F6 Series (K2 type)

25. PDC1.5 G (Lo)

Part number : FAR-F6CE-1G6190-K222

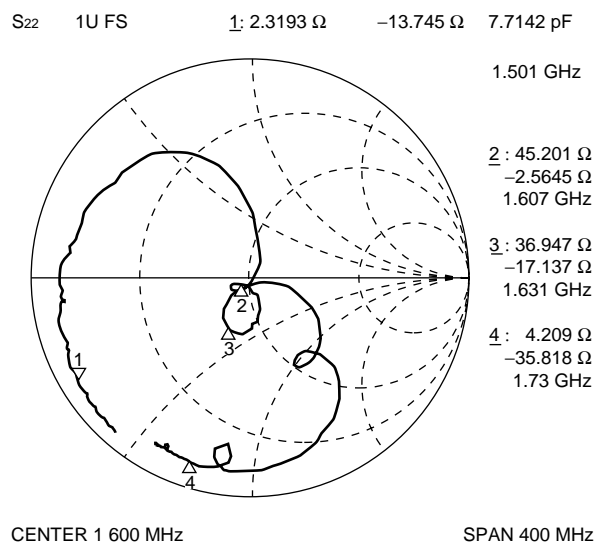
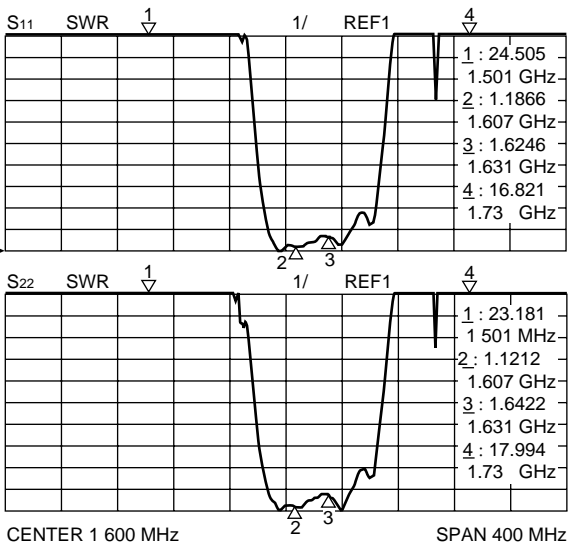
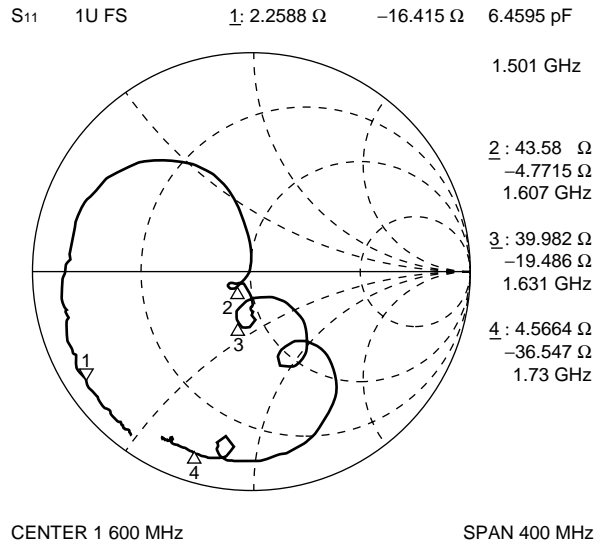
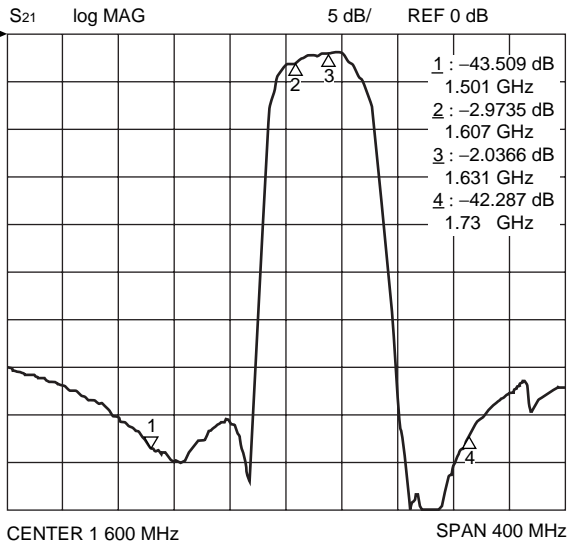

F5/F6 Series (K2 type)

MEASUREMENT CIRCUIT

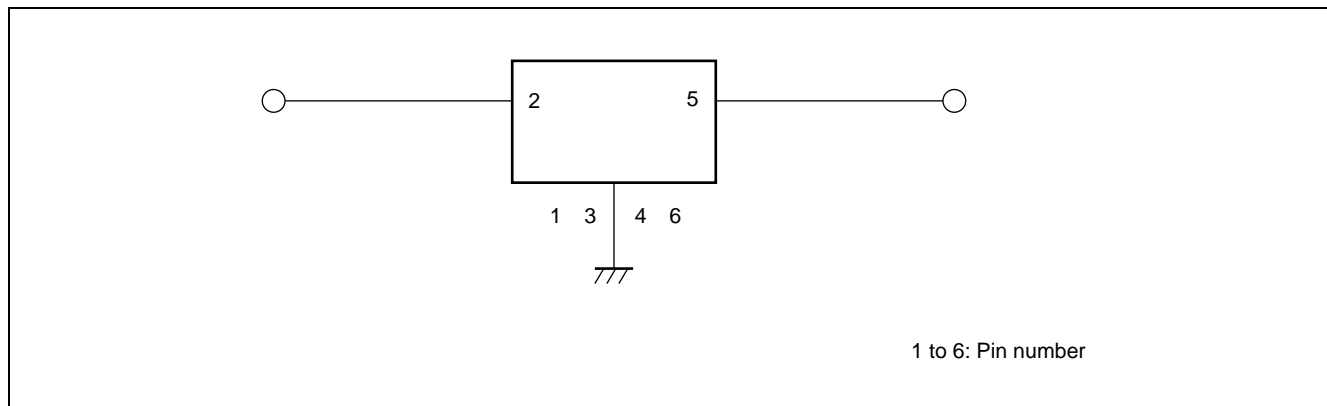

PART NUMBER DESIGNATION

[Designation example]

FAR-F□ CE-□□□□□□-K2 □□-□
(1) (2) (3) (4) (5)

- (1) Frequency range : 5 : 700 to 1000 MHz
6 : 1000 to 1700 MHz
- (2) Package size : E : 3.0 mm × 3.0 mm × 1.2 mm
- (3) Frequency : This specifies the nominal center frequency using six alphanumeric.
M (for MHz) or G (for GHz) indicates the decimal point.
[Example] 906.0 MHz ⇒ 906M00
1.441GHz ⇒ 1G4410
- (4) Part symbol : Numbers specified by Fujitsu
Refer to STANDARD FREQUENCIES.
- (5) Packing (Reeled tape) : W : 1 k pcs/reel
V : 3 k pcs/reel
U : 5 k pcs/ree

F5/F6 Series (K2 type)

■ MARKING

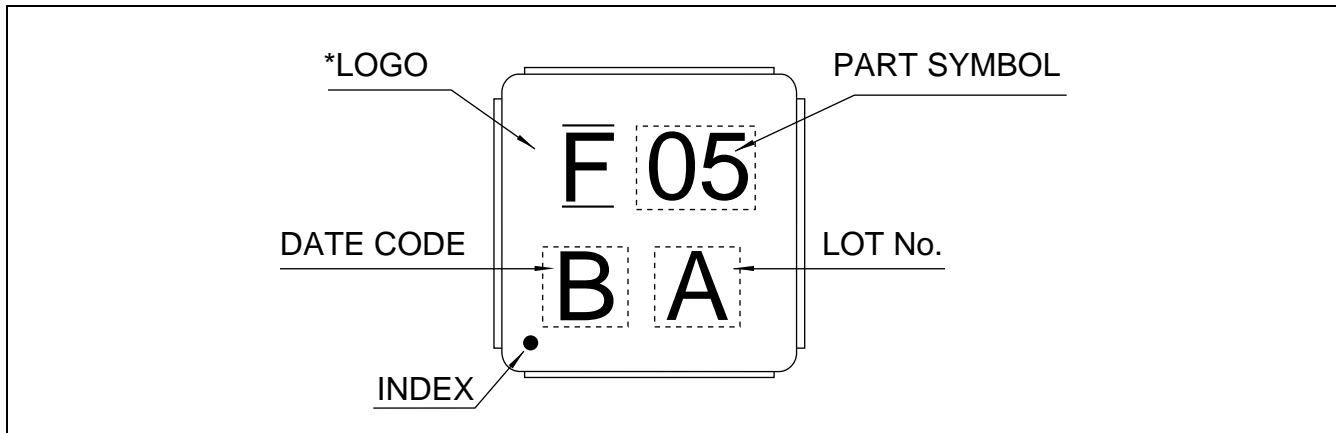

*For the following parts, "K" is marked in place of "F".

FAR-F5CE-836M50-K230
FAR-F5CE-836M50-K236
FAR-F5CE-881M50-K235
FAR-F5CE-947M50-K233
FAR-F5CE-897M50-K231
FAR-F5CE-942M50-K237
FAR-F5CE-906M50-K238

F5/F6 Series (K2 type)

■ PACKAGE DIMENSION

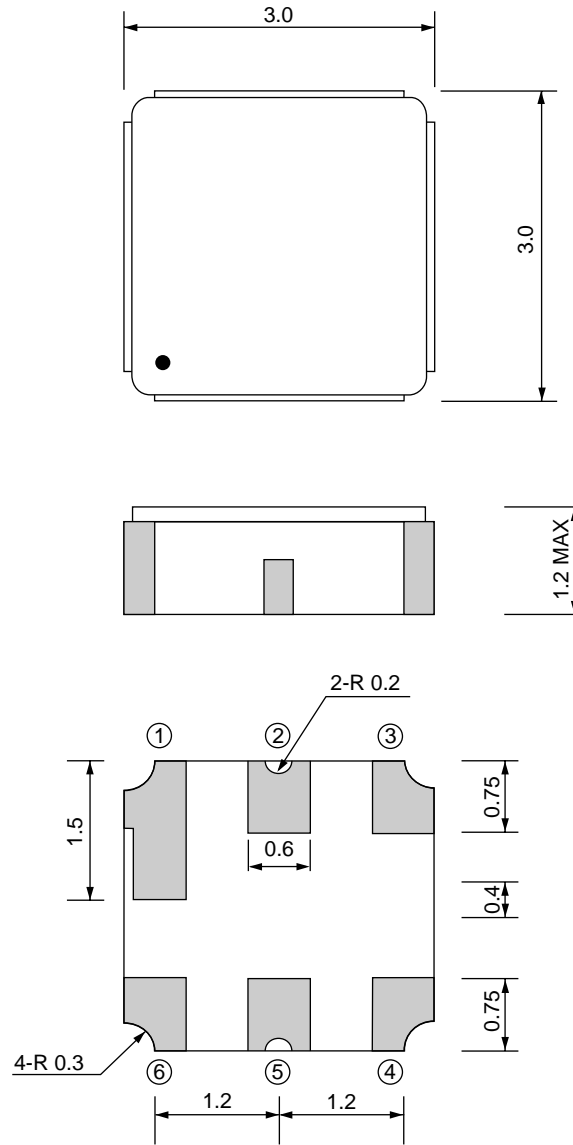

Dimensions in mm

RECOMMENDED LAND PATTERN

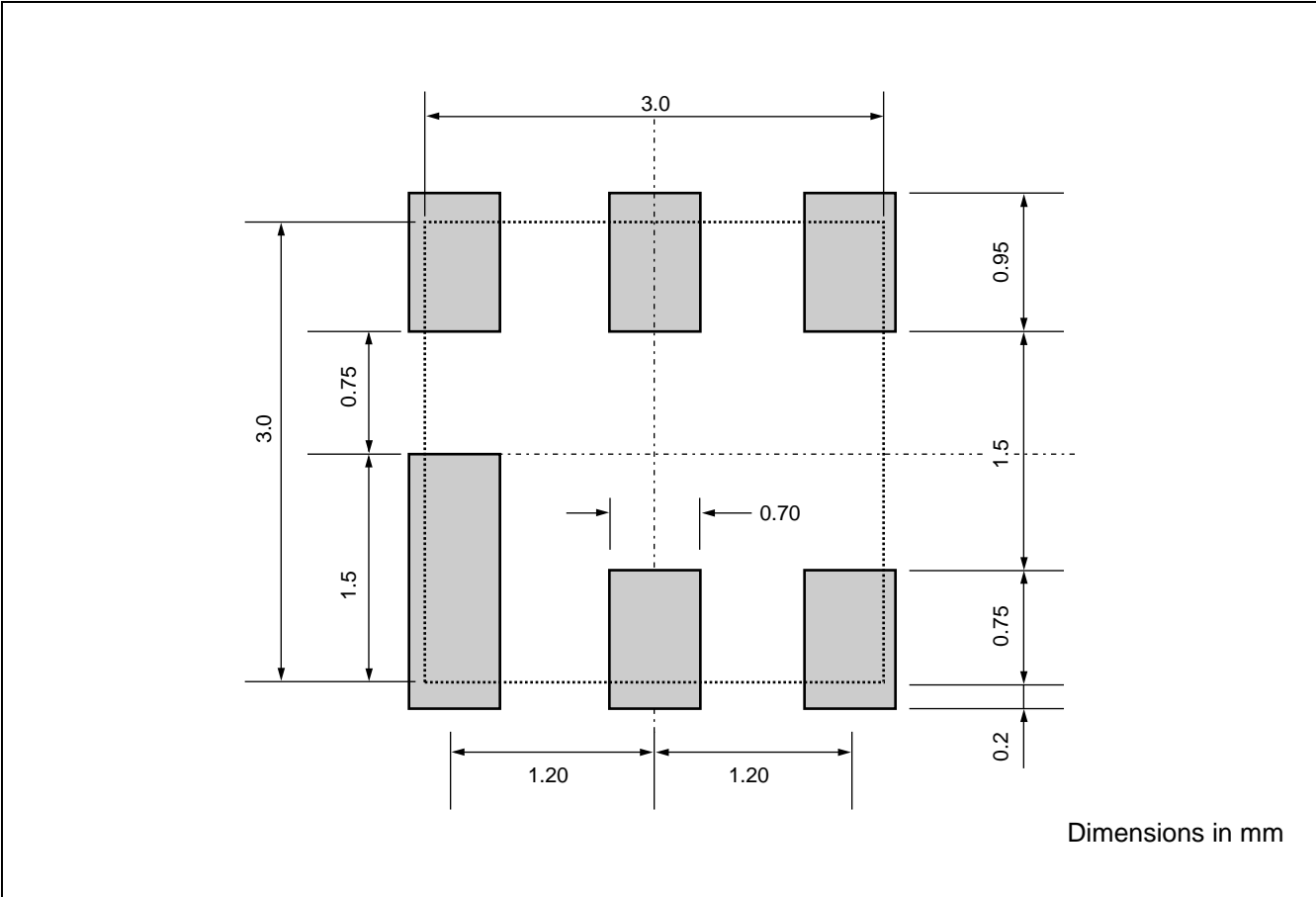

F5/F6 Series (K2 type)

■ PACKING : Reel type

1. Reel Dimensions

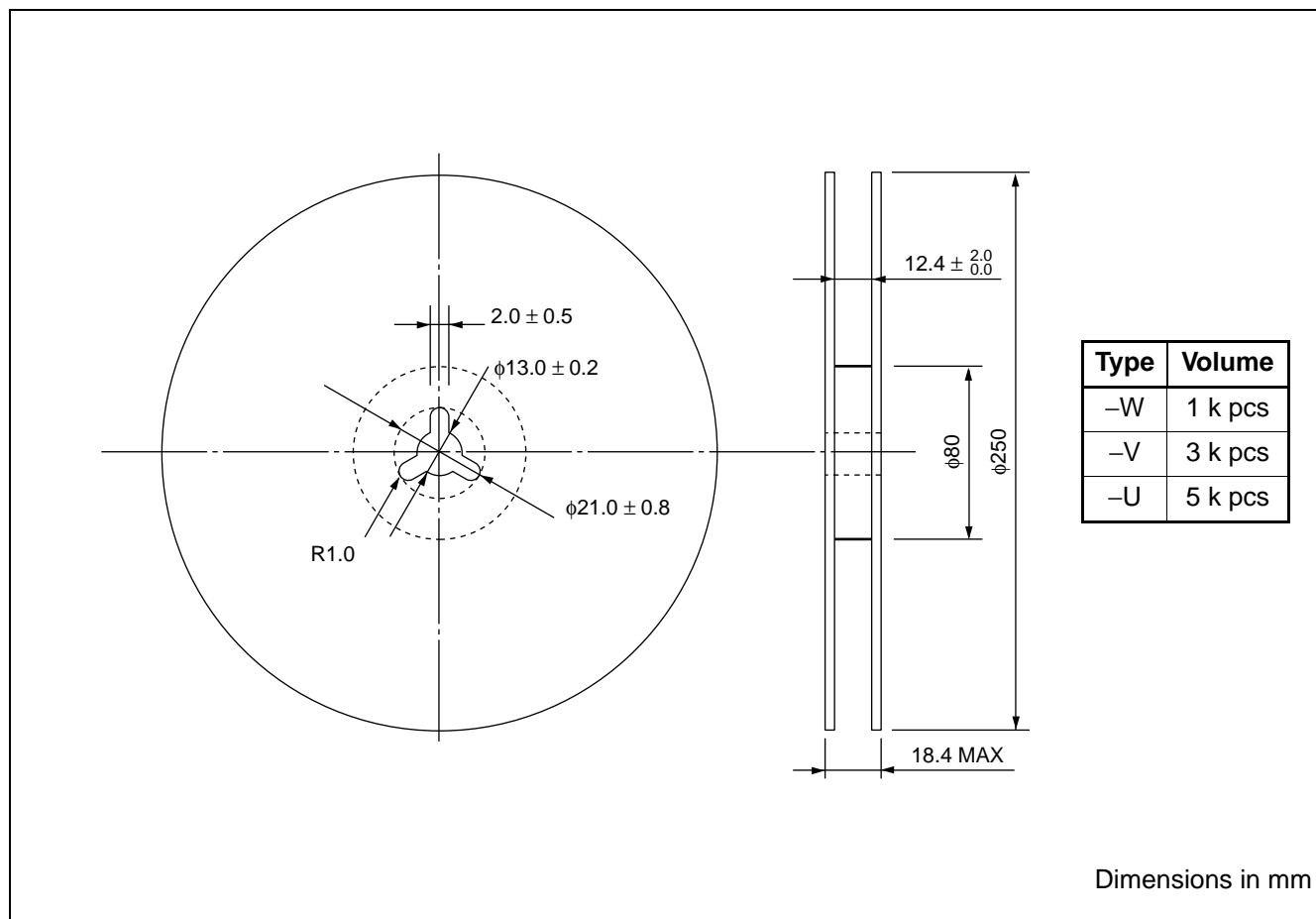

2. Packing Style

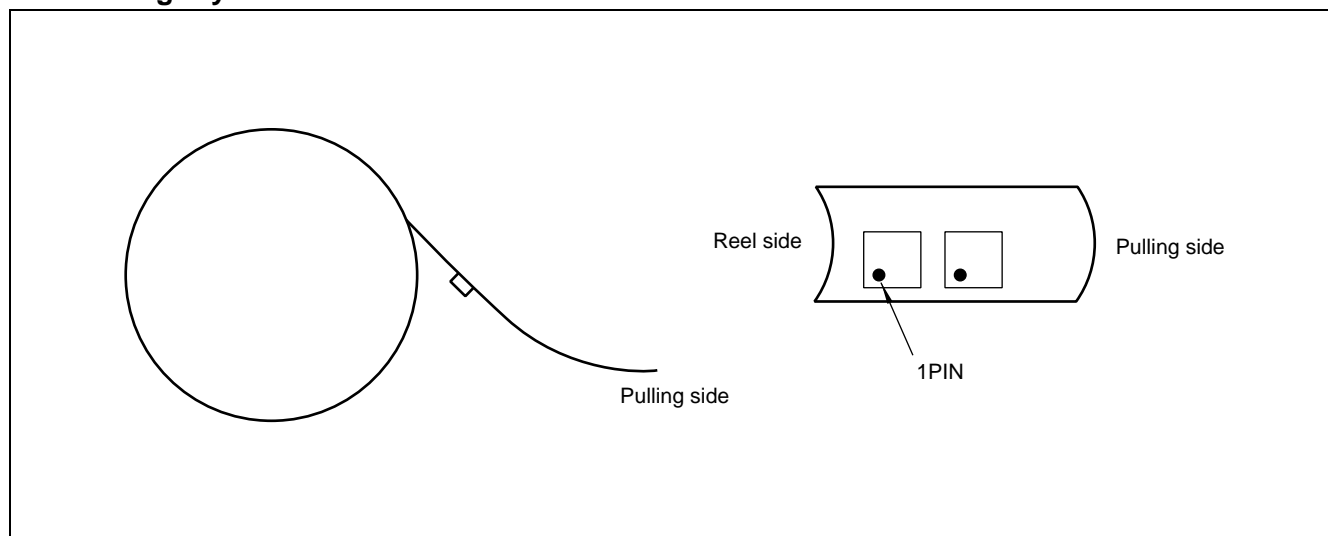

F5/F6 Series (K2 type)

3. Tape Dimensions

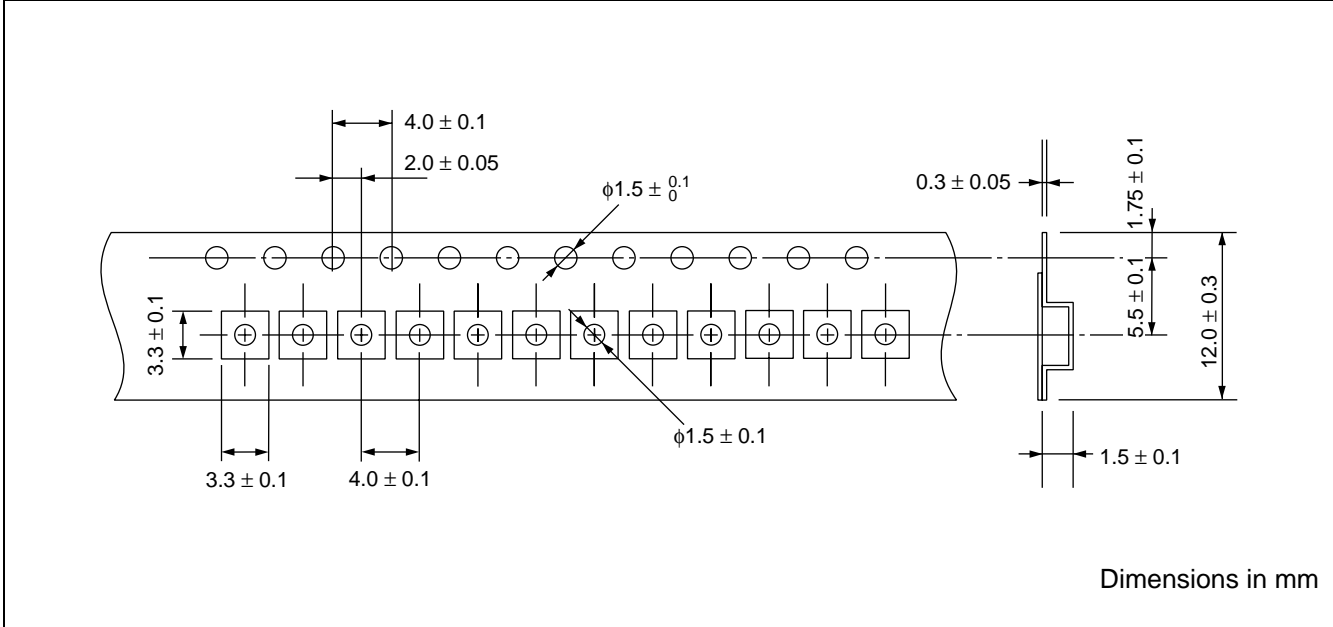

4. Peel strength of top cover tape

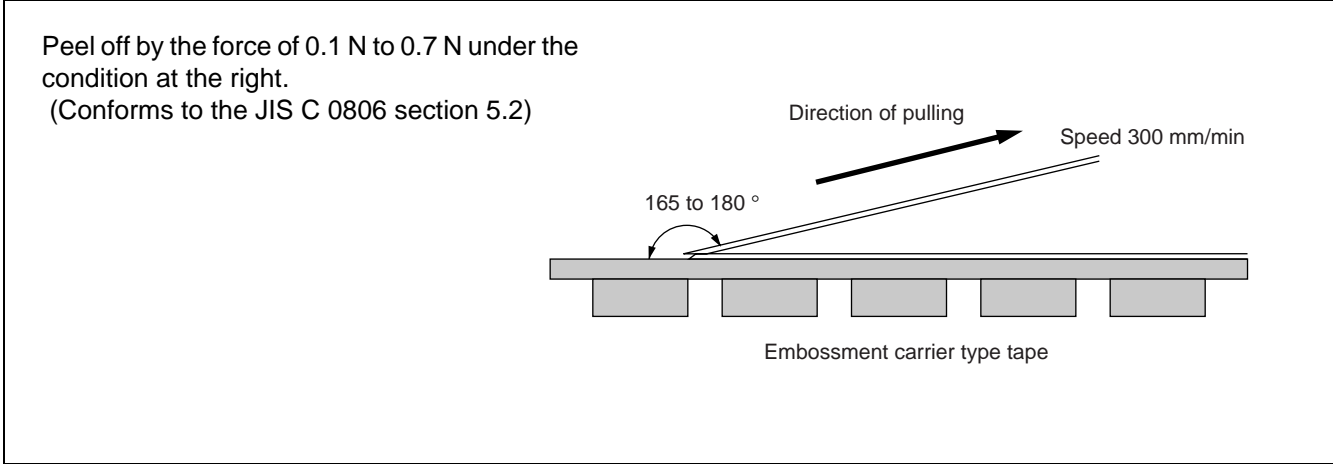

F5/F6 Series (K2 type)

RECOMMENDED REFLOW PROFILE

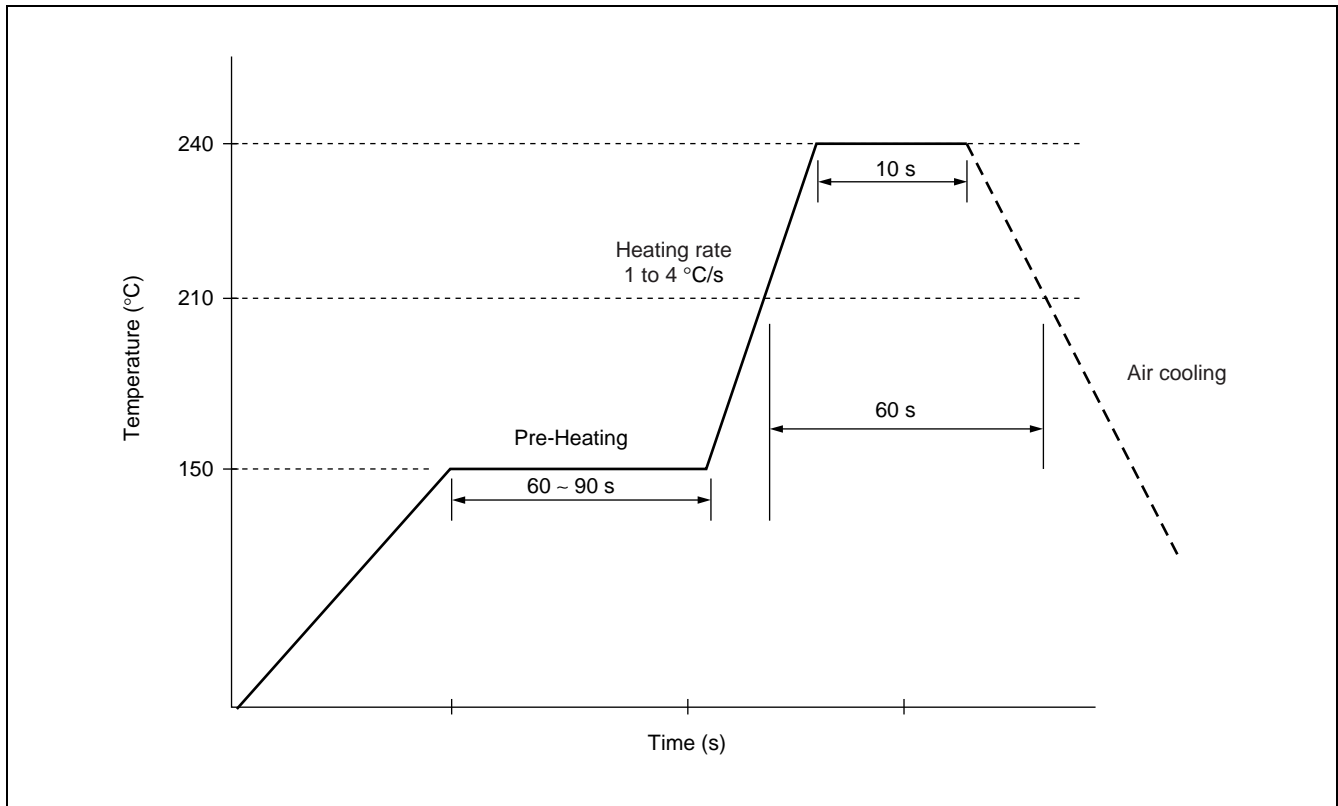

NOTE

A mass-produced product order is accepted by a unit of 1000.

F5/F6 Series (K2 type)

FUJITSU MEDIA DEVICES LIMITED

For further information please contact:

Japan

FUJITSU MEDIA DEVICE LIMITED
International Sales & Marketing DEPT.
Shin-Yokohama Square Bldg., 14F,
Shin-yokohama 2-3-12,
Kohoku-ku, Yokohama,
Kanagawa 222-0033, Japan
Tel: +81-45-471-0061
Fax: +81-45-471-0076

<http://www.fujitsu.co.jp/hypertext/fmd/English/index.html>

North and South America

FUJITSU MICROELECTRONICS, INC.
3545 North First Street,
San Jose, CA 95134-1804, U.S.A.
Tel: +1-408-922-9000
Fax: +1-408-922-9179

Customer Response Center
Mon. - Fri.: 7 am - 5 pm (PST)
Tel: +1-800-866-8608
Fax: +1-408-922-9179

<http://www.fujitsumicro.com/>

Europe

FUJITSU MICROELECTRONICS EUROPE GmbH
Am Siebenstein 6-10,
D-63303 Dreieich-Buchsschlag,
Germany
Tel: +49-6103-690-0
Fax: +49-6103-690-122

<http://www.fujitsu-fme.com/>

Asia Pacific

FUJITSU MICROELECTRONICS ASIA PTE. LTD.
#05-08, 151 Lorong Chuan,
New Tech Park,
Singapore 556741
Tel: +65-281-0770
Fax: +65-281-0220

<http://www.fmap.com.sg/>

F0011

© FUJITSU LIMITED Printed in Japan

All Rights Reserved.

The contents of this document are subject to change without notice. Customers are advised to consult with FUJITSU sales representatives before ordering.

The information and circuit diagrams in this document are presented as examples of semiconductor device applications, and are not intended to be incorporated in devices for actual use. Also, FUJITSU is unable to assume responsibility for infringement of any patent rights or other rights of third parties arising from the use of this information or circuit diagrams.

The contents of this document may not be reproduced or copied without the permission of FUJITSU LIMITED.

FUJITSU semiconductor devices are intended for use in standard applications (computers, office automation and other office equipments, industrial, communications, and measurement equipments, personal or household devices, etc.).

CAUTION:

Customers considering the use of our products in special applications where failure or abnormal operation may directly affect human lives or cause physical injury or property damage, or where extremely high levels of reliability are demanded (such as aerospace systems, atomic energy controls, sea floor repeaters, vehicle operating controls, medical devices for life support, etc.) are requested to consult with FUJITSU sales representatives before such use. The company will not be responsible for damages arising from such use without prior approval.

Any semiconductor devices have inherently a certain rate of failure. You must protect against injury, damage or loss from such failures by incorporating safety design measures into your facility and equipment such as redundancy, fire protection, and prevention of over-current levels and other abnormal operating conditions.

If any products described in this document represent goods or technologies subject to certain restrictions on export under the Foreign Exchange and Foreign Trade Control Law of Japan, the prior authorization by Japanese government should be required for export of those products from Japan.