

AEO/ALO Single Output 8th Brick: Baseplate or Open-Frame Module

The AEO_ALO04/12/20/25x48 series is Astec's Low Current 8th Brick industry standard offering. Operating from an input voltage range of 36V to 75V, the series provides 7 configured outputs starting from 1.2V all the way up to 12V. It delivers up to 25A max current for 1.8V and lower voltages at impressive levels of efficiency. It provides tight regulation and exhibits clean and monotonic output start up characteristics. The AEO_ALO series comes with industry standard features such as Input UVLO; non-latching OCP, OVP and OTP; Output Trim; Differential Remote Sense pins. Both baseplate (AEO) and open frame (ALO) construction are available as well as TH and SMT termination. With its wide operating temperature range of -40°C to 85°C ambient, the converters are deployable into almost any environment.



Special Features

- Industry Standard 8th Brick Footprint
- Baseplate or Open frame construction
- Low Ripple and Noise
- Regulation to zero load
- High Capacitive Load Start-up
- Fixed Switching Frequency
- Industry standard features: Input UVLO; Enable; non-latching OVP, OCP and OTP; Output Trim, Differential Remote Sense
- Meets Basic Insulation

Environmental Specifications

- -40°C to 85°C Operating Temperature
- -55°C to 125°C Storage Temperature
- MTBF > 1 million hours

Electrical Parameters

Input

Input Range	36-75 VDC
Input Surge	100V / 100ms

Control

Enable	TTL compatible
(Positive or Negative Logic Enable Options)	

Output

Load Current	Up to 25A max ($V_O \leq 1.8V$)
Line/Load Regulation	< 1% V_O
Ripple and Noise	20mV _{P-P} typical at 1.8V
Output Voltage	
Adjust Range	±10% V_O
Transient Response	2% Typical deviation 50% to 75% step load 250µs settling time (Typ)
Remote Sense	+10% V_O
Over Current Protection	120% (Typ)
Over Voltage Protection	130% (Typ)
Over Temperature Protection	110 °C

Safety

UL + cUL 60950, Recognized
 EN60950 through TUV-PS



Technical Reference Notes
AEO_ALO04/12/20/25x48 Series
(Single Output 8th Brick)



Electrical Specifications

ABSOLUTE MAXIMUM RATINGS

Stresses in excess of the absolute maximum ratings can cause permanent damage to the converter. Functional operation of the device is converter is not implied at these or any other conditions in excess of those given in the operational section of the specs. Exposure to absolute maximum ratings for extended period can adversely affect device reliability.

Parameter	Device	Symbol	Min	Typical	Max	Unit
Input Voltage Continuous Transient (100ms)	All	V _{in} V _{in trans}	-0.3 -	- -	75 100	Vdc
I/O Isolation Input-to-Output	All	-	1500	-	-	Vdc
Operating Temperature ¹	All	T _A	-40	-	85	°C
Storage Temperature	All	T _{STG}	-55	-	125	°C
Operating Humidity	All	-	10	-	85	%
Max Voltage at Enable Pin	All	-	-0.6	-	25	Vdc
Max Output Power	B (12V0) A (5V0) F (3V3) G (2V5) Y (1V8) M (1V5) K (1V2)	P _{O, MAX}	- - - - - - -	- - - - - - -	48.0 60.0 66.0 50.0 45.0 37.5 30.0	W

INPUT SPECIFICATIONS

Parameter	Device	Symbol	Min	Typical	Max	Unit
Operating Input Voltage Range	All	V _{IN}	36	48	75	Vdc
Input Under-Voltage Lock-out T _{ON} Threshold T _{OFF} Threshold	All		33 31	34 32	36 34	Vdc
Max Input Current ²	B (12V0) A (5V0) F (3V3) G (2V5) Y (1V8) M (1V5) K (1V2)	I _{in max}	- - - - - - -	- - - - - - -	1.7 2.3 2.4 1.9 1.8 1.6 1.4	A
Standing Loss V _{in} = V _{in nom}	B (12V0) A (5V0) F (3V3) G (2V5) Y (1V8) M (1V5) K (1V2)		- - - - - - -	- - - - - - -	5.75 4.00 4.00 4.00 3.00 2.50 2.00	W



Technical Reference Notes
AEO_ALO04/12/20/25x48 Series
(Single Output 8th Brick)



Electrical Specifications (continued)

INPUT SPECIFICATIONS

Parameter	Device	Symbol	Min	Typical	Max	Unit
Input Ripple Current ³	All	I_{II}	-	10	20	mAp-p
Inrush Current i^2t	All		-	0.01	-	A ² s

OUTPUT SPECIFICATIONS

Parameter	Device	Symbol	Min	Typical	Max	Unit
Output Voltage Set point $V_{IN} = V_{IN, MIN}$ to $V_{IN, MAX}$ $I_O = I_{O, MAX}$	B (12V0) A (5V0) F (3V3) G (2V5) Y (1V8) M (1V5) K (1V2)	$V_{O, SET}$	11.80 4.90 3.25 2.45 1.76 1.47 1.17	12.00 5.00 3.30 2.50 1.80 1.50 1.20	12.20 5.10 3.35 2.55 1.84 1.53 1.23	Vdc
Output Regulation Line $V_{IN} = V_{IN, MIN}$ to $V_{IN, MAX}$ Load $V_{IN} = V_{IN, NOM}$ $I_O = I_{O, MIN}$ to $I_{O, MAX}$ Temp $V_{IN} = V_{IN, NOM}$; $I_O = I_{O, MAX}$ ⁴	All	- - -	- - -	0.1 0.1 0.5	0.2 0.5 1.0	%
Output Current ⁴	B (12V0) A (5V0) F (3V3) G (2V5) Y (1V8) M (1V5) K (1V2)	I_O	0 0 0 0 0 0 0	- - - - - - -	4 12 20 20 25 25 25	A
Output Ripple and Noise ⁵ Peak-to-Peak $I_O = I_{O, MAX}$; $V_{IN} = V_{IN, NOM}$ BWL = 20 MHz; $T_A = 25^\circ\text{C}$	B (12V0) A (5V0) F (3V3) G (2V5) Y (1V8) M (1V5) K (1V2)	- - - - - - -	- - - - - - -	50 40 40 20 20 20 20	120 90 75 75 60 60 60	mVp-p



Technical Reference Notes
AEO_ALO04/12/20/25x48 Series
(Single Output 8th Brick)



Electrical Specifications (continued)

OUTPUT SPECIFICATIONS

Parameter	Device	Symbol	Min	Typical	Max	Unit
Output Current-limit Inception $V_O = 90\% V_{O,NOM}$; $T_A = 25^\circ C$ $V_{IN} = V_{IN,NOM}$ Non-latching / auto-recovery	B (12V0)	$I_{O, OCP}$	5.0	-	7.8	A
	A (5V0)		16.0	-	23.9	
	F (3V3)		23.5	-	30.0	
	G (2V5)		23.5	-	30.0	
	Y (1V8)		27.0	-	48.0	
	M (1V5)		27.0	-	48.0	
	K (1V2)		27.0	-	48.0	
External Load Capacitance $I_O = I_{O, MAX}$, resistive load	All	C_{EXT}	-	-	10,000	μF
	B (12V0)		-	-	1,500	
Capacitor ESR			4		-	$m\Omega$
Efficiency $V_{IN} = V_{IN,NOM}$; $I_O = I_{O, MAX}$ $T_A = 25^\circ C$	B (12V)	η	92.0	93.0	94.0	%
	A (5.0V)	η	92.0	93.0	94.0	
	F (3.3V)	η	90.0	91.0	93.0	
	G (2.5V)	η	89.0	90.0	92.0	
	Y (1.8V)	η	88.5	90.0	91.0	
	M (1.5V)	η	87.0	88.5	90.5	
	K (1.2V)	η	85.0	87.0	88.0	
Output Over Voltage Protection Non-latching / autorecovery	B (12V)	$V_{O, OVP}$	13.8	14.4	15.0	V
	A (5.0V)		5.80	6.00	6.20	
	F (3.3V)		3.80	4.00	4.30	
	G (2.5V)		2.90	3.00	3.20	
	Y (1.8V)		2.10	2.30	2.50	
	M (1.5V)		1.75	1.85	2.38	
	K (1.2V)		1.38	1.50	1.80	
Over Temperature Protection	AEO		110	-	120	$^\circ C$
	ALO		110	-	120	
Input to Output Turn-On Delay $V_{IN} = V_{IN,NOM}$ $I_O = I_{O, MAX}$	All	-	-	-	17	ms
	5V, 12V	-	-	-	20	
Enable to Output Turn-On Delay $V_{IN} = V_{IN,NOM}$ $I_O = I_{O, MAX}$	All	-	-	-	17	ms
		-	-	-	20	
Output Voltage Rise Time 10% to 90% of V_O $V_{IN} = V_{IN,NOM}$ $I_O = I_{O, MAX}$	All	-	-	3	9	ms
	5V	-	-	4	11	
	12V	-	-	9	16	
Switching Frequency	All	F_{SW}	380	450	520	kHz
Output Voltage Remote Sensing	All	-	-	-	10	$\%V_O$
Output Voltage Trim Range ⁶	All		90		110	$\%V_O$
Output Voltage Overshoot	All	-	-	0	3	$\%V_O$



Technical Reference Notes
AEO_ALO04/12/20/25x48 Series
(Single Output 8th Brick)



Electrical Specifications (continued)

OUTPUT SPECIFICATIONS

Parameter	Device	Symbol	Min	Typical	Max	Unit
Dynamic Response $di/dt = 0.1 \text{ A}/\mu\text{s}$						
Peak Deviation $\Delta I_O = 50\% \text{ to } 75\% \text{ of } I_{O_{max}}$	All	-	-	2	5	%
Settling Time $V_{ref} = V_{O_{nom}}$	All	-	-	-	250	μs
Peak Deviation $\Delta I_O = 50\% \text{ to } 25\% \text{ of } I_{O_{max}}$	All	-	-	2	5	%
Settling Time $V_{ref} = V_{O_{nom}}$	All	-	-	-	250	μs
Output Enable ON/OFF Open collector TTL compatible						
Positive Enable: Mod-ON	All	-	2.95	-	20	V
Mod-OFF	All	-	-0.5	-	1.20	V
Negative Enable: Mod-ON	All	-	-0.5	-	1.20	V
Mod-OFF	All	-	2.95	-	20	V

- Note:
1. Derating curves for both openframe and baseplate modules are based on derated component junction temperatures of 120°C or less where applicable.
 2. An input line fuse is recommended for use (e.g. Littlefuse type 314 – 4A max, 250V min or equivalent).
 3. Refer to Figure 1 for Input Ripple Current test measurement setup.
 4. Output derating applies at elevated temperature.
 5. Refer to Figure 2 for output ripple measurement setup.
 6. Refer to the output trim equations provided (Equations 1 and 2).

SAFETY AGENCY / MATERIAL RATING / ISOLATION

Parameter	Device					
Safety Approval	All	UL/cUL 60950, 3rd Edition – Recognized EN 60950 through TUV				
Material Flammability Rating	All	UL94V-0				
Parameter	Device	Symbol	Min	Typical	Max	Unit
Input to Output Capacitance	All		-	1000	-	pF
Input to Output Resistance	All		-	TBD	-	Ohms
Input to Output Insulation Type	All		-	Basic	-	-

Electrical Specifications (continued)

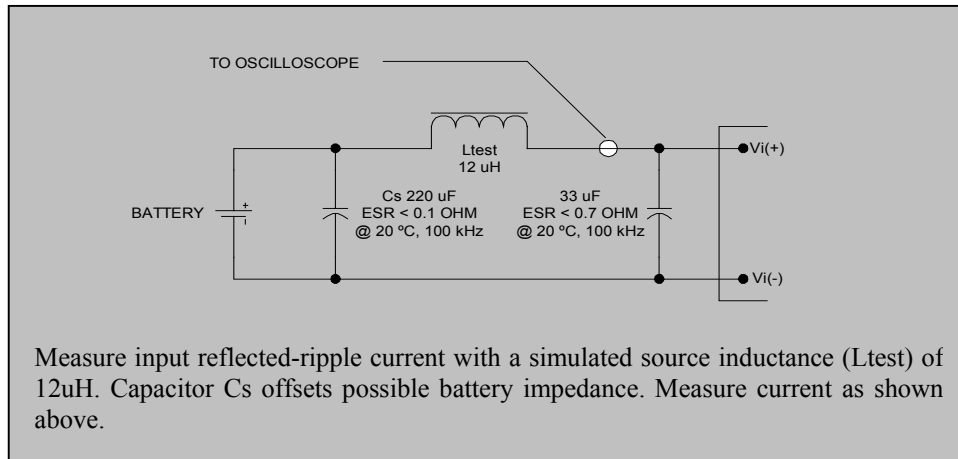

Figure 1. Input Reflected Ripple Current Measurement Setup.

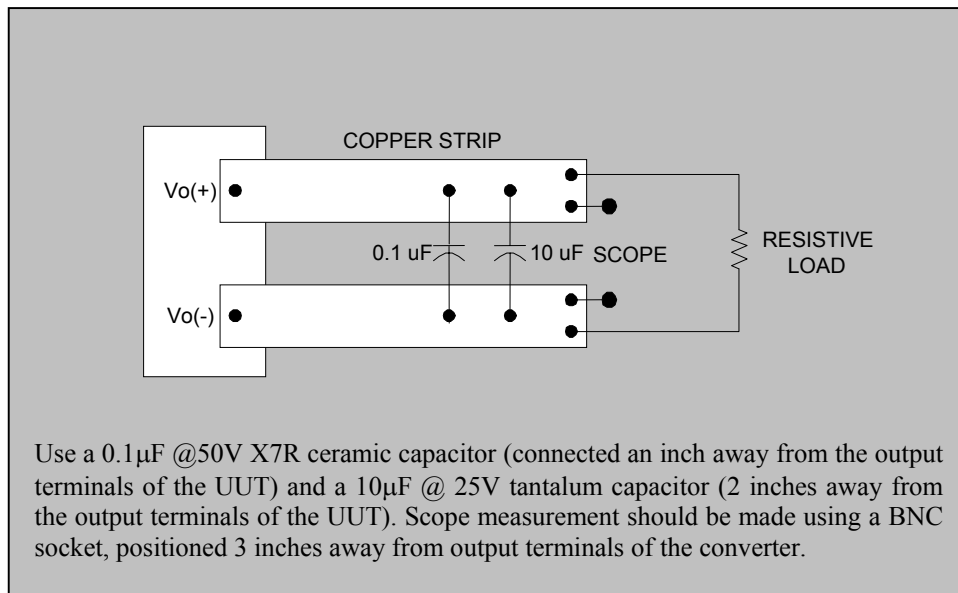

Figure 2. Peak to Peak Output Noise Measurement Setup.

Basic Operation and Features

INPUT UNDER VOLTAGE LOCKOUT

To prevent any instability to the converter, which may affect the end system, the converter have been designed to turn-on once V_{IN} is in the voltage range of 33 to 36VDC. Likewise, it has also been programmed to turn-off when V_{IN} drops down to 31 to 34VDC

OUTPUT VOLTAGE ADJUST/TRIM

The converter comes with a TRIM pin (PIN 6), which is used to adjust the output by as much as 90% to 110% of its set point. This is achieved by connecting an external resistor as described below.

To **INCREASE** the output, external R_{adj_up} resistor should be connected between TRIM PIN (Pin6) and +SENSE PIN (Pin 7). Please refer to Equation (1) for the required external resistance and output adjust relationship.

Equation (1a): 1.5V to 12V

$$R_{adj_up} = \left[\frac{5.1 \times V_{o_set} \times (100 + \Delta\%)}{1.225 \times \Delta\%} - \frac{510}{\Delta\%} - 10.2 \right] \text{ K}\Omega$$

Equation (1b): 1.2V

$$R_{adj_up} = \left[\frac{5.1 \times V_{o_set} \times (100 + \Delta\%)}{0.6 \times \Delta\%} - \frac{510}{\Delta\%} - 10.2 \right] \text{ K}\Omega$$

To **DECREASE** the output, external R_{adj_down} resistor should be connected between TRIM pin (Pin 6) and -SENSE PIN (Pin 5). Please refer to Equation (2) for the required external resistance and output adjust relationship.

Equation (2):

$$R_{adj_down} = \left(\frac{510}{\Delta\%} - 10.2 \right) \cdot \text{k}\Omega$$

Where: $\Delta\%$ = percent change in output voltage

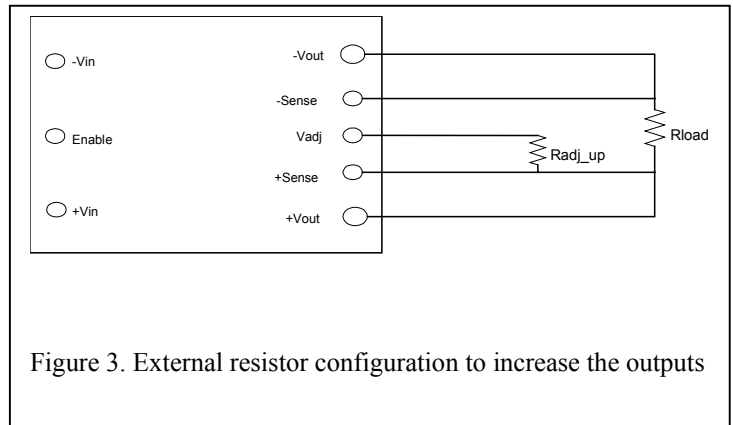

Figure 3. External resistor configuration to increase the outputs

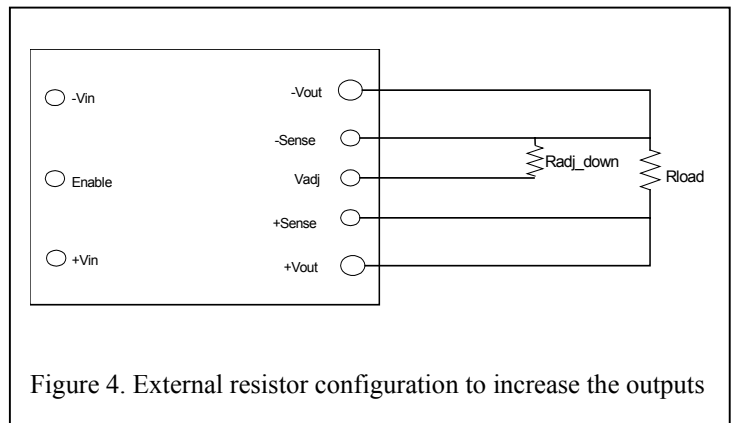

Figure 4. External resistor configuration to decrease the outputs



Technical Reference Notes

AEO_ALO04/12/20/25x48 Series

(Single Output 8th Brick)



Basic Operation and Features *(continued)*

OUTPUT ENABLE

The converter comes with an Enable pin (PIN 2), which is primarily used to turn ON/OFF the converter. Both a Positive (no "N" suffix required) and a Negative (suffix "N" required) Enable Logic options are being offered. Please refer to Table 2 for the Part Numbering Scheme.

For Positive Enable, the converter is turned on when the Enable pin is at logic HIGH or left open. The unit turns off when the Enable pin is at logic LOW or directly connected to $-V_{IN}$. On the other hand, the Negative Enable version turns unit on when the Enable pin is at logic LOW or directly connected to $-V_{IN}$. The unit turns off when the Enable pin is at Logic HIGH.

OUTPUT OVER VOLTAGE PROTECTION (OVP)

The Over Voltage Protection circuit is non-latching - auto recovery mode. The output of the converter is terminated under an OVP fault condition ($V_o > OVP$ threshold). The converter will attempt to restart until the fault is removed. There is a 100ms lockout period between restart attempts.

OVER CURRENT PROTECTION (OCP)

The Over Current Protection is non-latching - auto recovery mode. The converter shuts down once the output current reaches the OCP range. The converter will attempt to restart until the fault is removed. There is a 100ms lockout period between restart attempts.

OVER TEMPERATURE PROTECTION (OTP)

The Over Temperature Protection circuit will shutdown the converter once the average PCB temperature (See Figure 62B for OTP reference sense point) reaches the OTP range. This feature prevents the unit from overheating and consequently going into thermal runaway, which may further damage the converter and the end system. Such overheating may be an effect of operation outside the given power thermal derating conditions. Restart is possible once the temperature of the sensed location drops to less than 110°C.

REMOTE SENSE

The remote sense pins can be used to compensate for any voltage drops (per indicated max limits) that may occur along the connection between the output pins to the load. Pin 7 (+Sense) and Pin 5 (-Sense) should be connected to Pin 8 (+Vout) and Pin 4 (Return) respectively at the point where regulation is desired. The combination of remote sense and trim adjust cannot exceed 110% of V_o . When output voltage is trimmed up (through remote sensing and/or trim pin), output current must be derated and maximum output power must not be exceeded.

Performance Curves

12V @ 4A

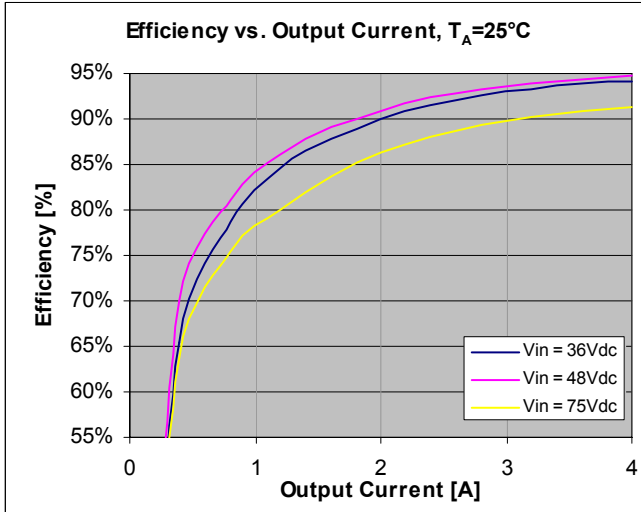

Figure 5. Efficiency vs. Load Current at $I_O = \text{Full Load}$, $T_A = 25^\circ\text{C}$ (ambient temperature).

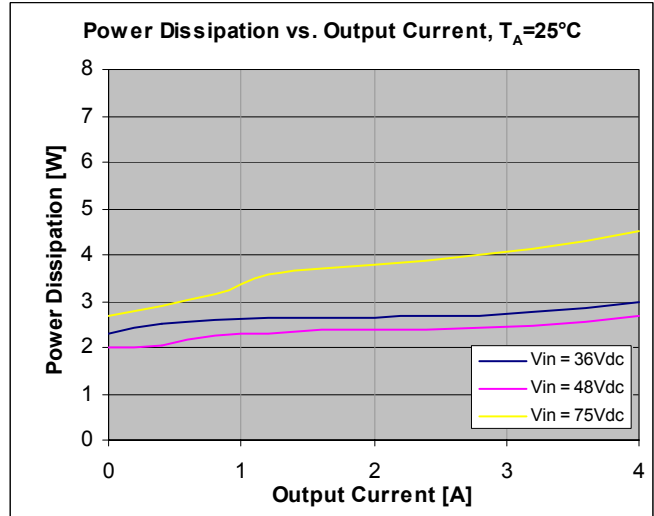

Figure 6. Power Dissipation vs. Load Current at $I_O = \text{Full Load}$, $T_A = 25^\circ\text{C}$ (ambient temperature).

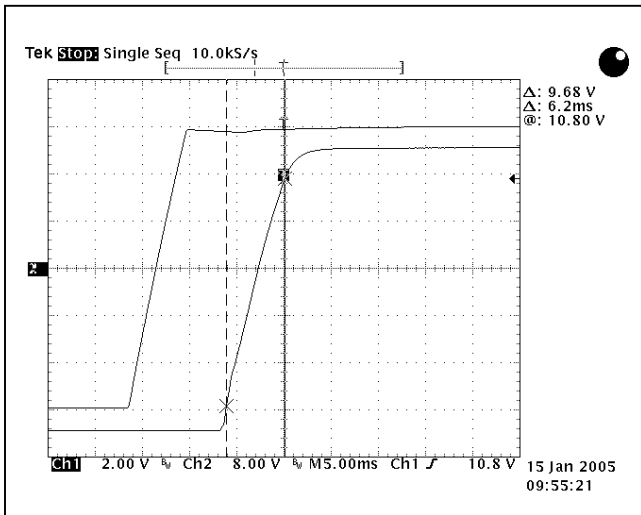

Figure 7. 12V_{OUT} Startup Characteristic at $V_{IN} = 48\text{Vdc}$, $I_O = \text{Full Load}$, $T_A = 25^\circ\text{C}$.

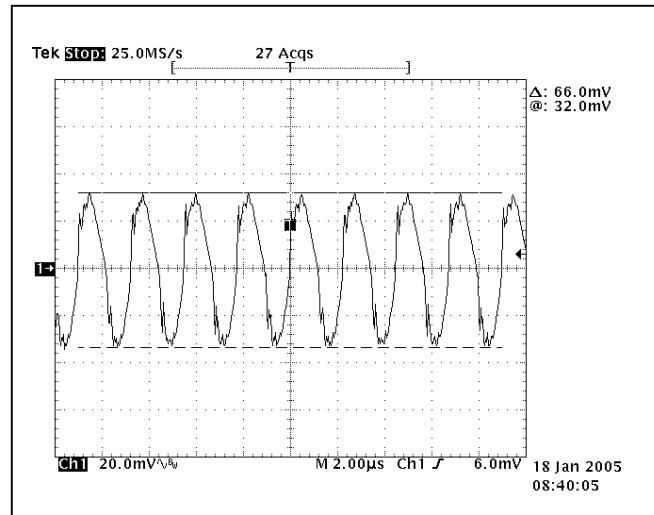

Figure 8. 12V_{OUT} Ripple Waveform at $V_{IN} = 48\text{Vdc}$, $I_O = \text{Full Load}$, $T_A = 25^\circ\text{C}$.

Performance Curves

12V @ 4A (continued)

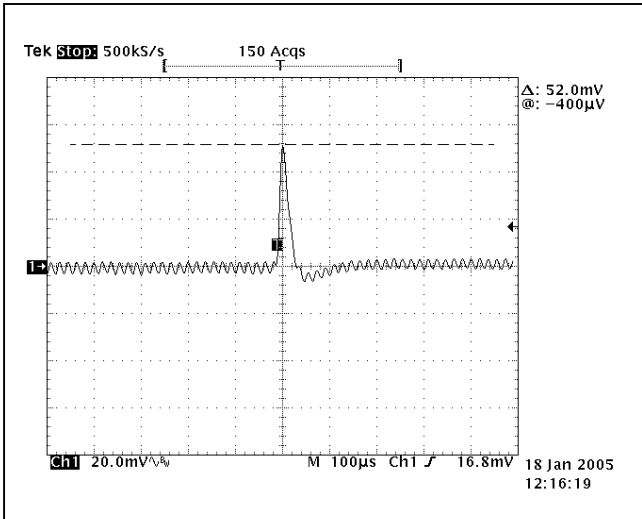

Figure 9. Transient Response at $T_A = 25^\circ\text{C}$, 12V_{OUT} Deviation (Hi-Lo).

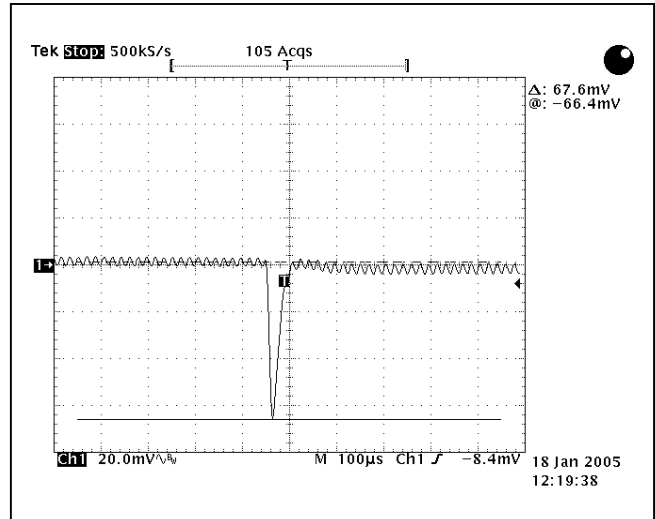

Figure 10. Transient Response at $T_A = 25^\circ\text{C}$, 12V_{OUT} Deviation (Lo-Hi).

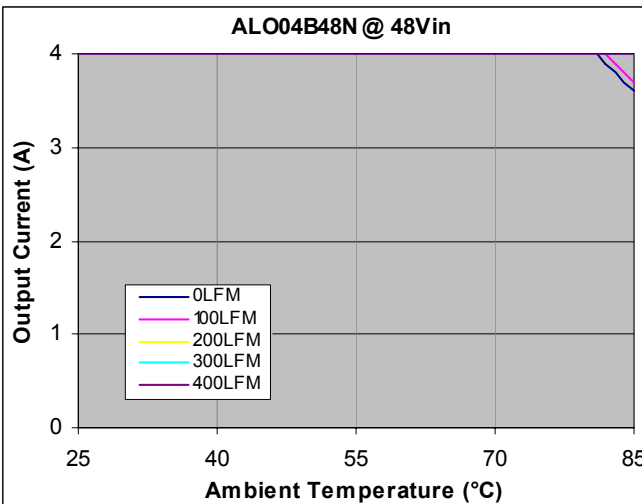

Figure 11. Output Current vs. Temperature for open frame version at $V_{IN} = 48\text{Vdc}$, $T_A = 25^\circ\text{C}$.

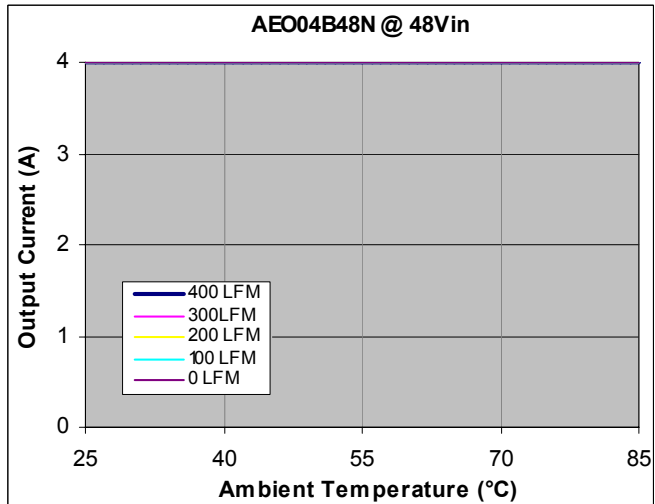

Figure 12. Output Current vs. Temperature for baseplate version at $V_{IN} = 48\text{Vdc}$, $T_A = 25^\circ\text{C}$.

Performance Curves

5V @ 12A

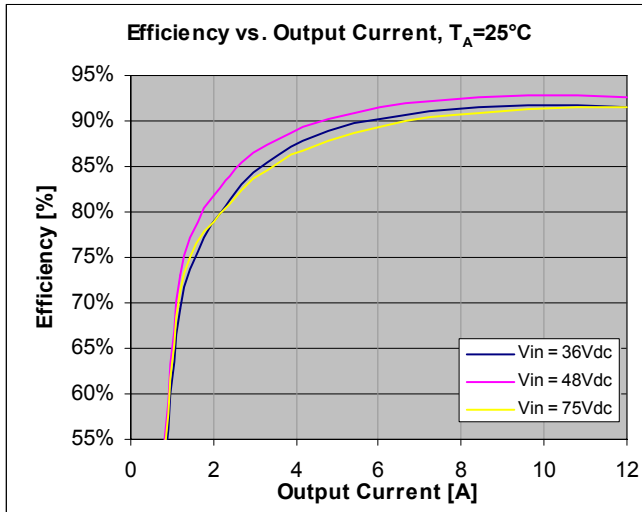

Figure 13. Efficiency vs. Load Current at $I_O = \text{Full Load}$, $T_A = 25^\circ\text{C}$ (ambient temperature).

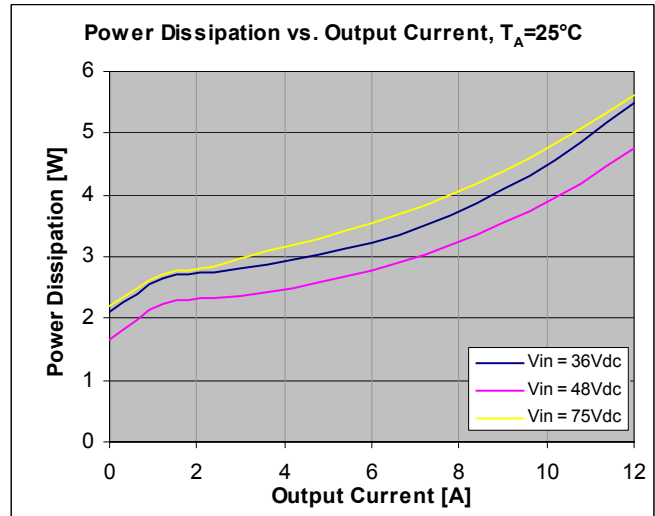

Figure 14. Power Dissipation vs. Load Current at $I_O = \text{Full Load}$, $T_A = 25^\circ\text{C}$ (ambient temperature).

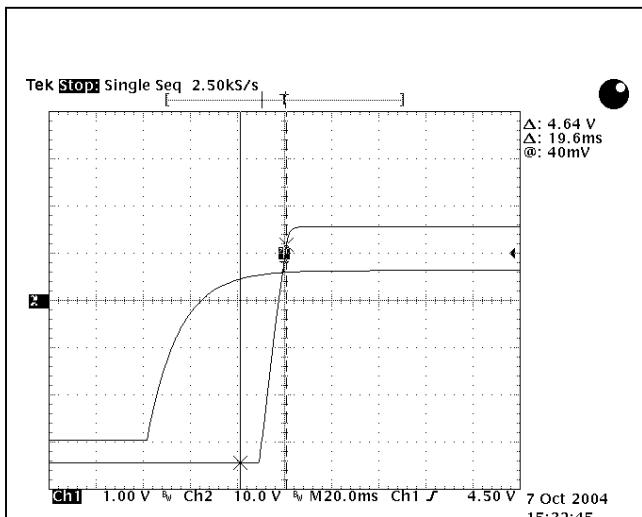

Figure 15. $5V_{OUT}$ Startup Characteristic at $V_{IN} = 48\text{Vdc}$, $I_O = \text{Full Load}$, $T_A = 25^\circ\text{C}$.

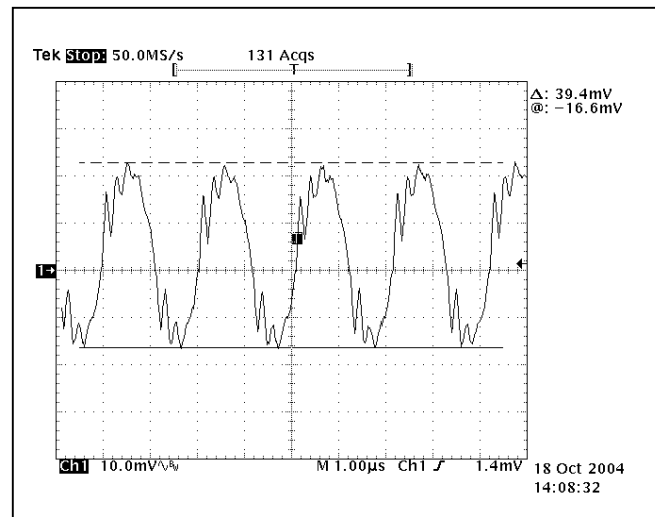

Figure 16. $5V_{OUT}$ Ripple Waveform at $V_{IN} = 48\text{Vdc}$, $I_O = \text{Full Load}$, $T_A = 25^\circ\text{C}$.

Performance Curves

5V @ 12A (continued)

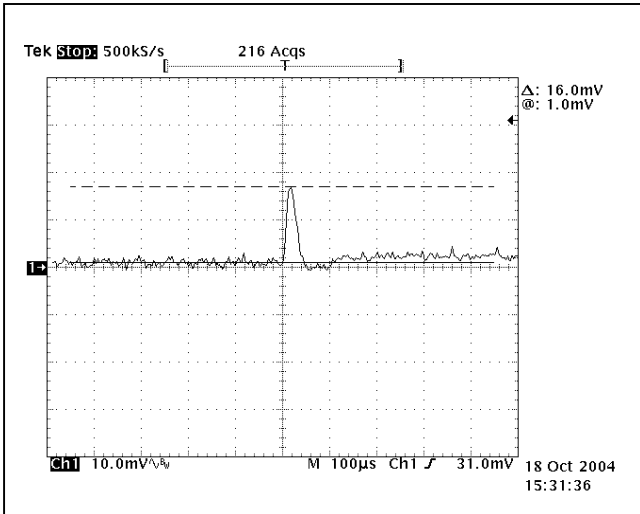

Figure 17. Transient Response at $T_A = 25^\circ\text{C}$, $5V_{\text{OUT}}$ Deviation (Hi-Lo).

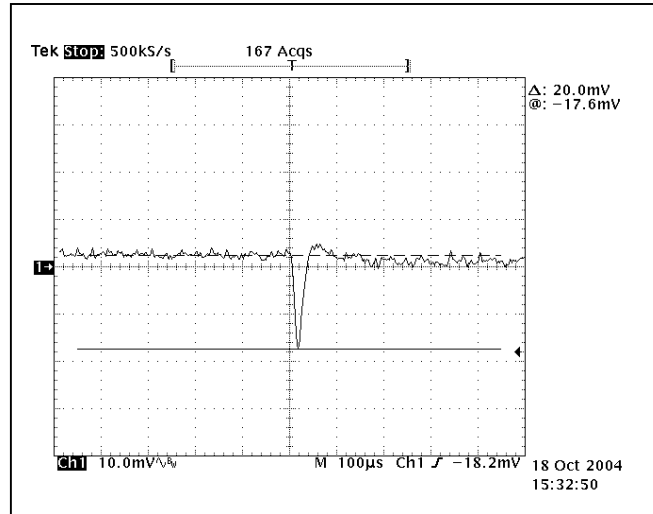

Figure 18. Transient Response at $T_A = 25^\circ\text{C}$, $5V_{\text{OUT}}$ Deviation (Lo-Hi).

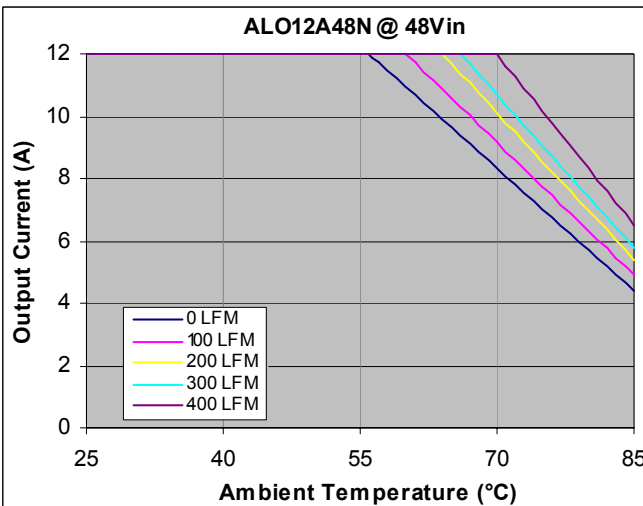

Figure 19. Output Current vs. Temperature for open frame version at $V_{\text{IN}} = 48\text{Vdc}$, $T_A = 25^\circ\text{C}$.

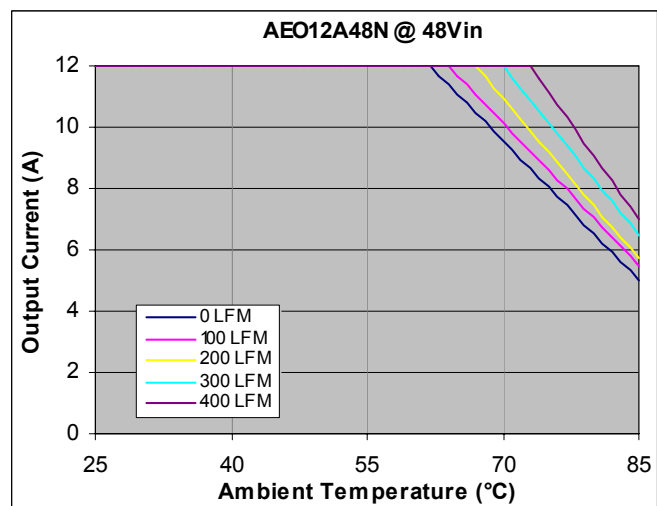

Figure 20. Output Current vs. Temperature for baseplate version at $V_{\text{IN}} = 48\text{Vdc}$, $T_A = 25^\circ\text{C}$.

Performance Curves

3.3V @ 20A

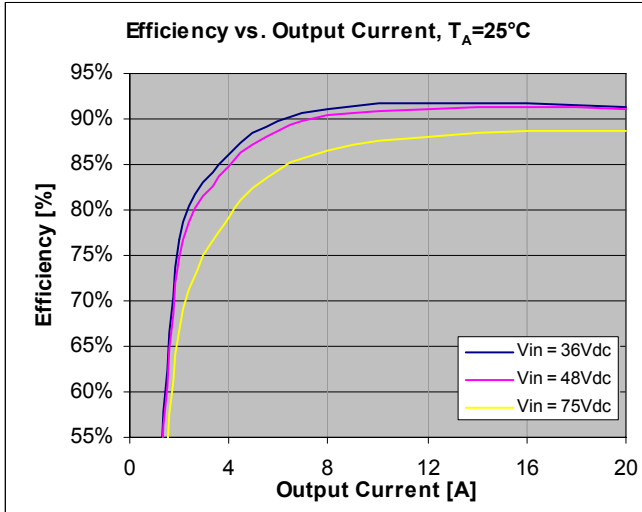

Figure 21. Efficiency vs. Load Current at $I_O = \text{Full Load}$, $T_A = 25^\circ\text{C}$ (ambient temperature).

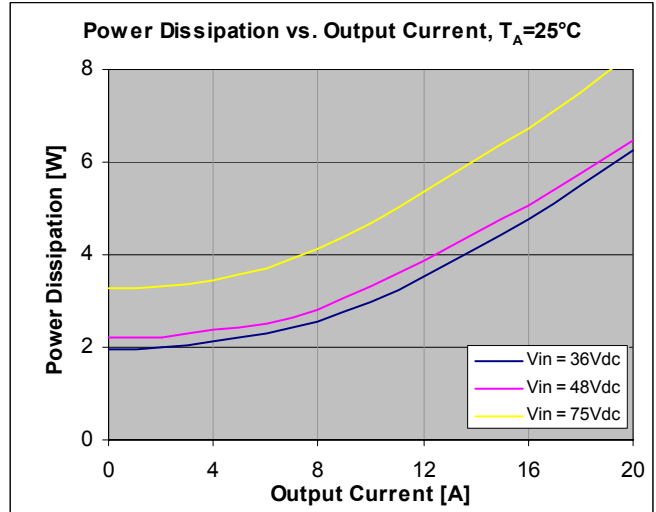

Figure 22. Power Dissipation vs. Load Current at $I_O = \text{Full Load}$, $T_A = 25^\circ\text{C}$ (ambient temperature).

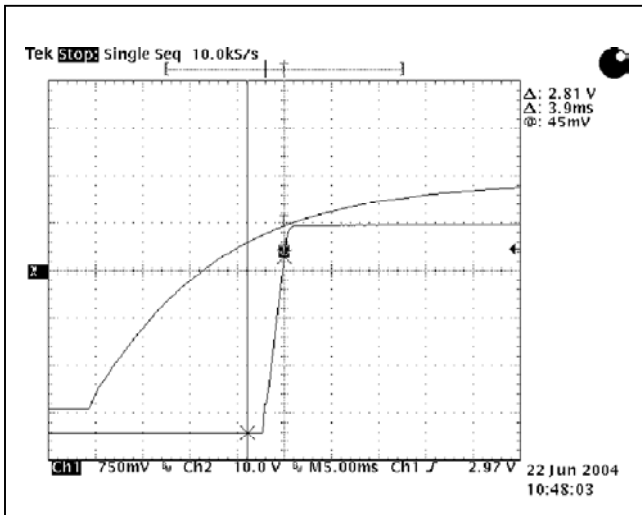

Figure 23. 3.3V_{OUT} Startup Characteristic at $V_{IN} = 48\text{Vdc}$, $I_O = \text{Full Load}$, $T_A = 25^\circ\text{C}$.

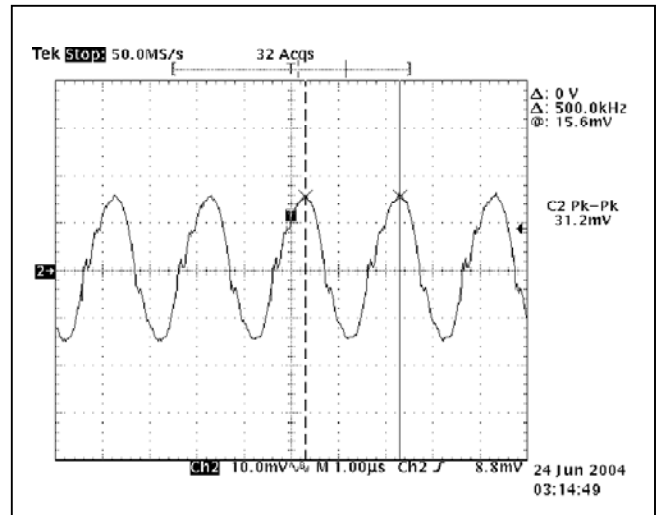

Figure 24. 3.3V_{OUT} Ripple Waveform at $V_{IN} = 48\text{Vdc}$, $I_O = \text{Full Load}$, $T_A = 25^\circ\text{C}$.

Performance Curves

3.3V @ 20A (continued)

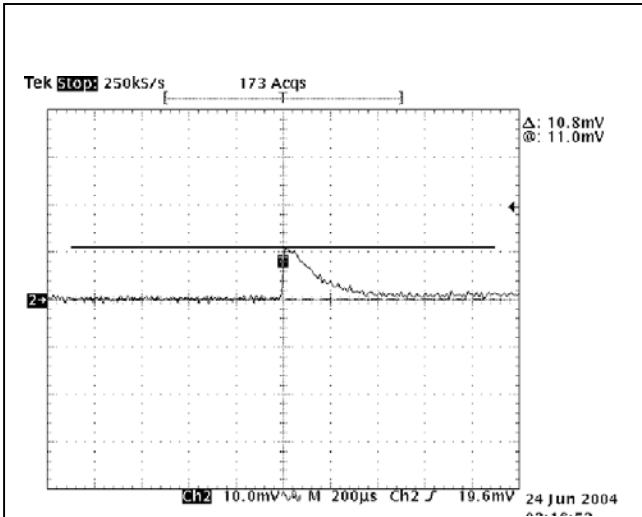

Figure 25. Transient Response at $T_A = 25^\circ\text{C}$, 3.3V_{OUT} Deviation (Hi-Lo).

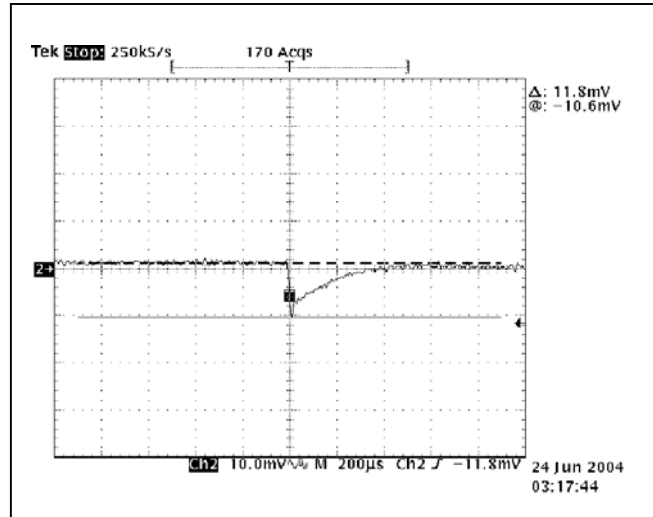

Figure 26. Transient Response at $T_A = 25^\circ\text{C}$, 3.3V_{OUT} Deviation (Lo-Hi).

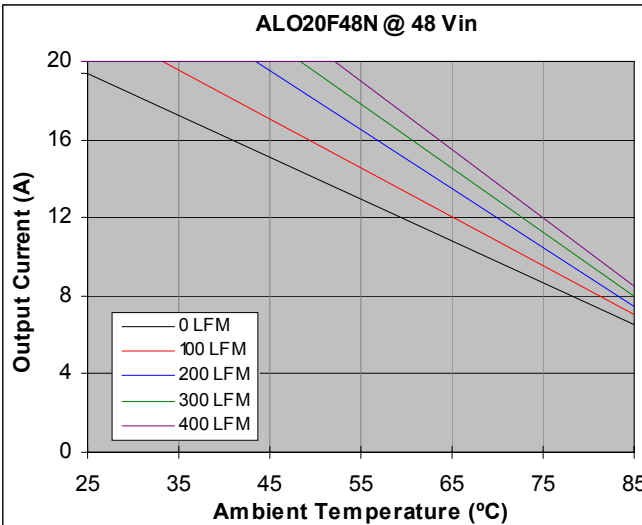

Figure 27. Output Current vs. Temperature for open frame version at $V_{IN} = 48\text{Vdc}$, $T_A = 25^\circ\text{C}$.

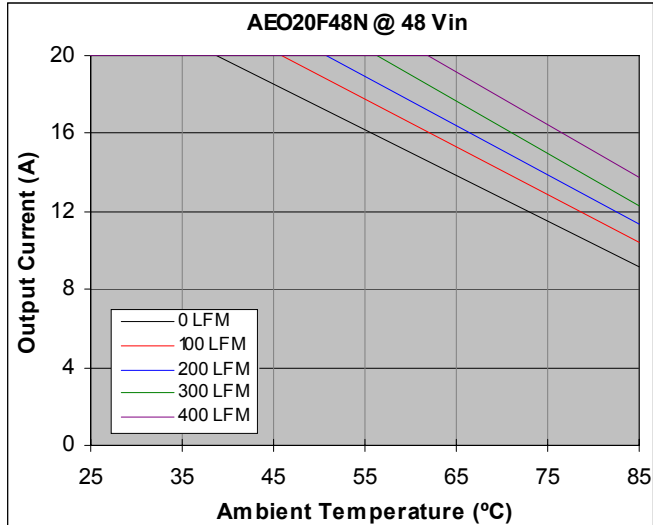

Figure 28. Output Current vs. Temperature for baseplate version at $V_{IN} = 48\text{Vdc}$, $T_A = 25^\circ\text{C}$.

Performance Curves

2.5V @ 20A

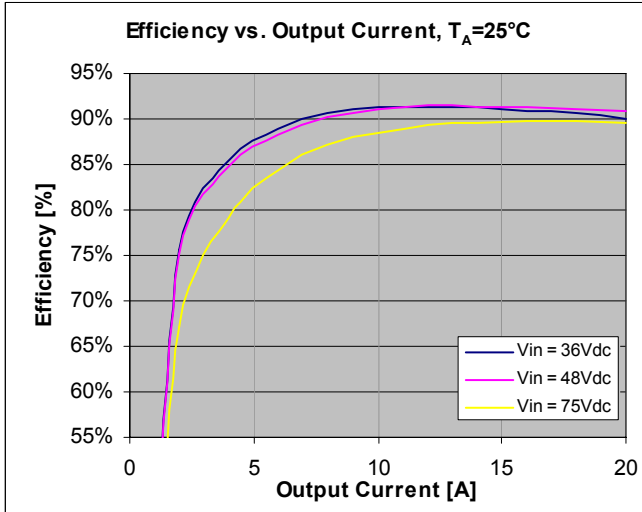

Figure 29. Efficiency vs. Load Current at $I_O = \text{Full Load}$, $T_A = 25^\circ\text{C}$ (ambient temperature).

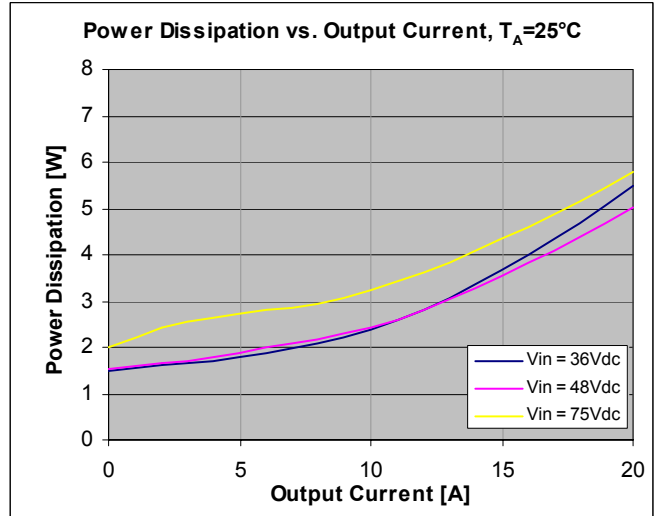

Figure 30. Power Dissipation vs. Load Current at $I_O = \text{Full Load}$, $T_A = 25^\circ\text{C}$ (ambient temperature).

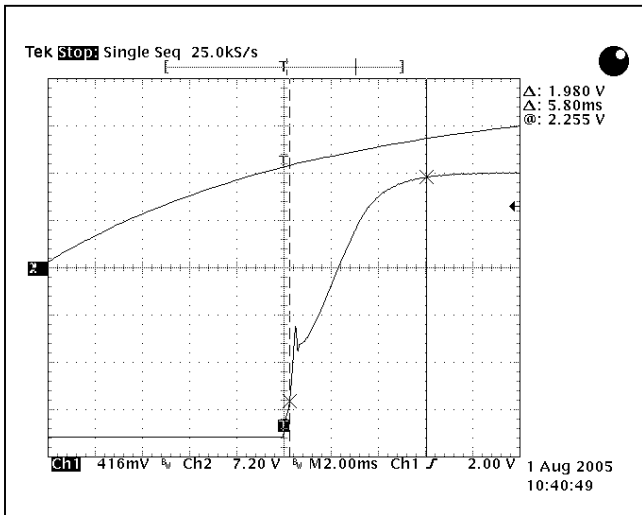

Figure 31. 2.5V_{OUT} Startup Characteristic at $V_{IN} = 48\text{Vdc}$, $I_O = \text{Full Load}$, $T_A = 25^\circ\text{C}$.

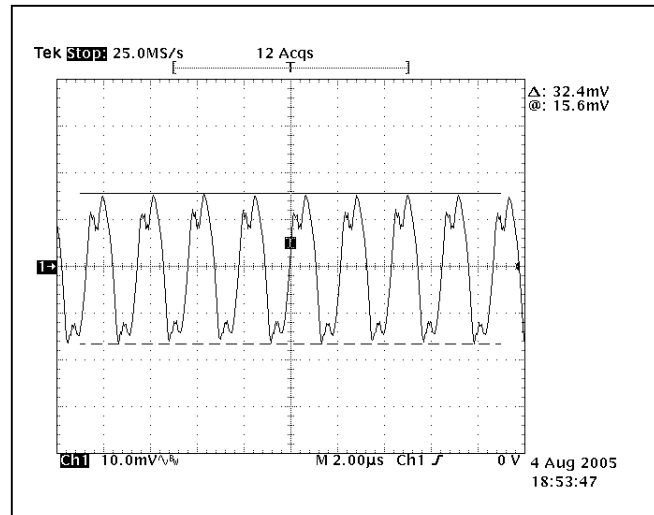

Figure 32. 2.5V_{OUT} Ripple Waveform at $V_{IN} = 48\text{Vdc}$, $I_O = \text{Full Load}$, $T_A = 25^\circ\text{C}$.

Performance Curves

2.5V @ 20A (continued)

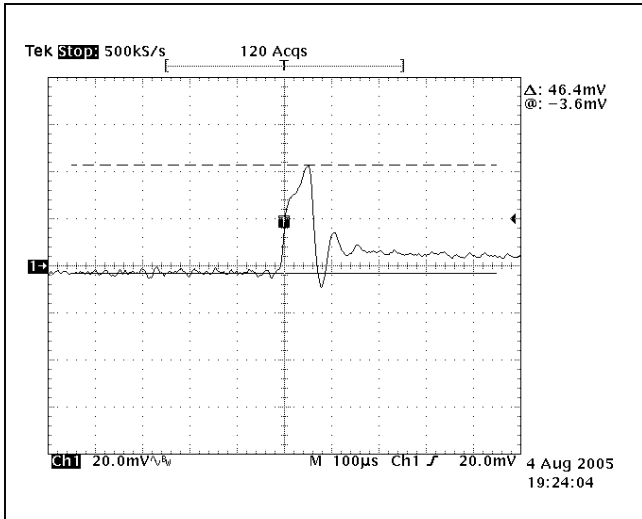

Figure 33. Transient Response at $T_A = 25^\circ\text{C}$, $2.5V_{OUT}$ Deviation (Hi-Lo).

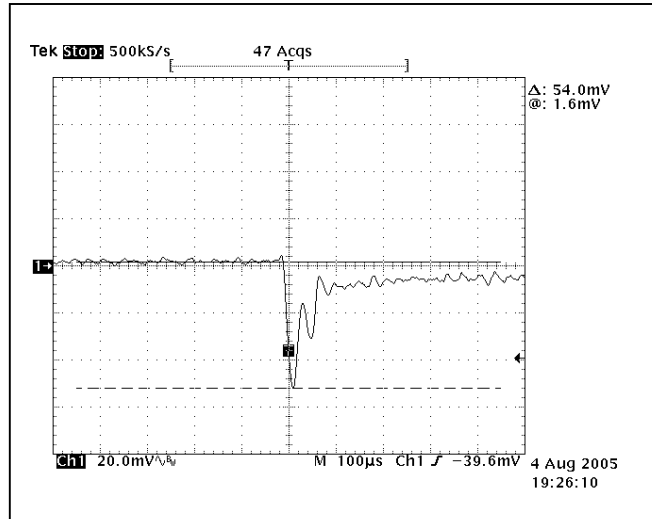

Figure 34. Transient Response at $T_A = 25^\circ\text{C}$, $2.5V_{OUT}$ Deviation (Lo-Hi).

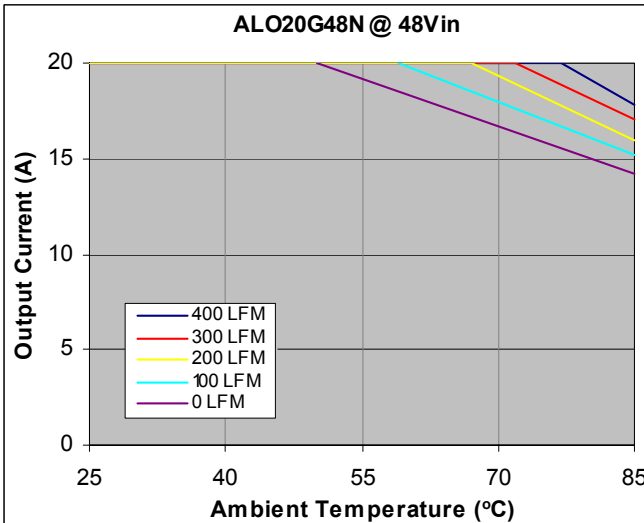

Figure 35. Output Current vs. Temperature for open frame version at $V_{IN} = 48\text{Vdc}$, $T_A = 25^\circ\text{C}$.

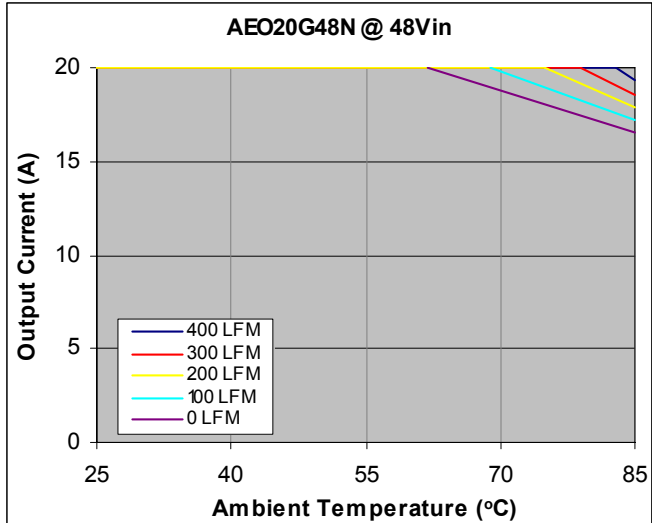

Figure 36. Output Current vs. Temperature for baseplate version at $V_{IN} = 48\text{Vdc}$, $T_A = 25^\circ\text{C}$.

Performance Curves

1.8V @ 25A

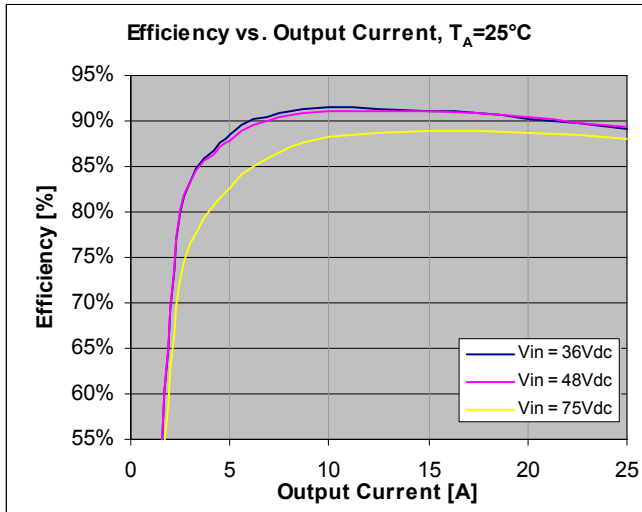

Figure 37. Efficiency vs. Load Current at $I_O = \text{Full Load}$, $T_A = 25^\circ\text{C}$ (ambient temperature).

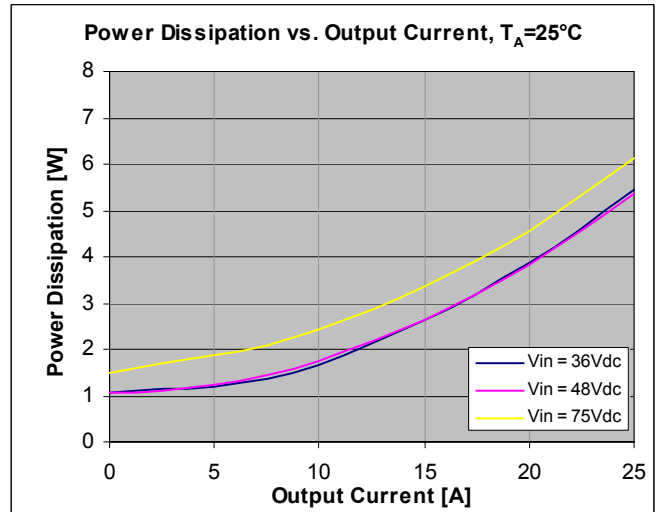

Figure 38. Power Dissipation vs. Load Current at $I_O = \text{Full Load}$, $T_A = 25^\circ\text{C}$ (ambient temperature).

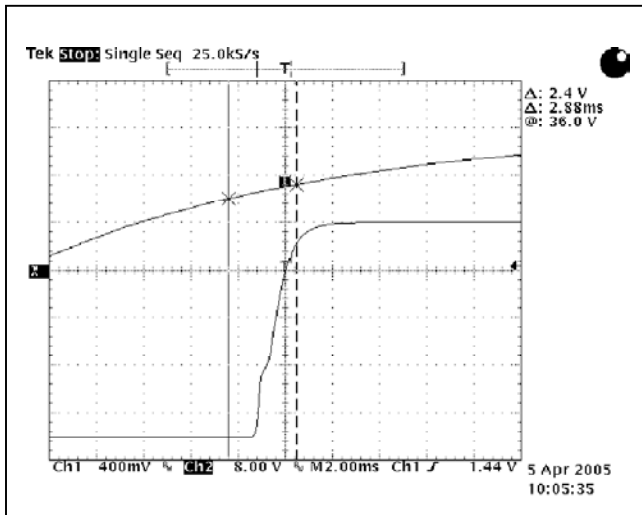

Figure 39. $1.8V_{OUT}$ Startup Characteristic at $V_{IN} = 48Vdc$, $I_O = \text{Full Load}$, $T_A = 25^\circ\text{C}$.

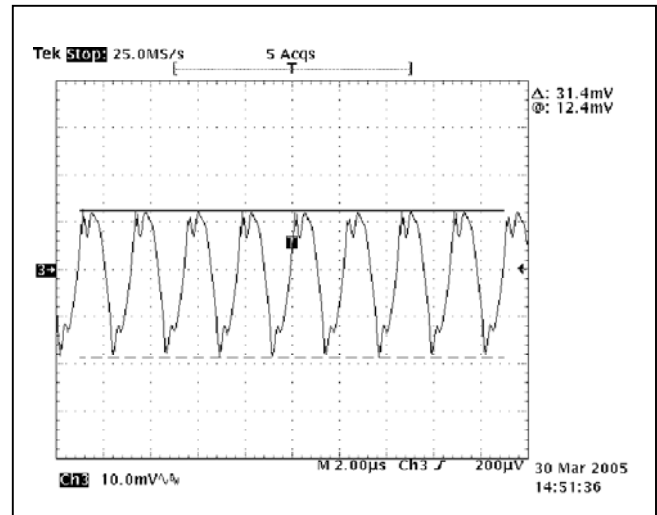

Figure 40. $1.8V_{OUT}$ Ripple Waveform at $V_{IN} = 48Vdc$, $I_O = \text{Full Load}$, $T_A = 25^\circ\text{C}$.

Performance Curves

1.8V @ 25A (continued)

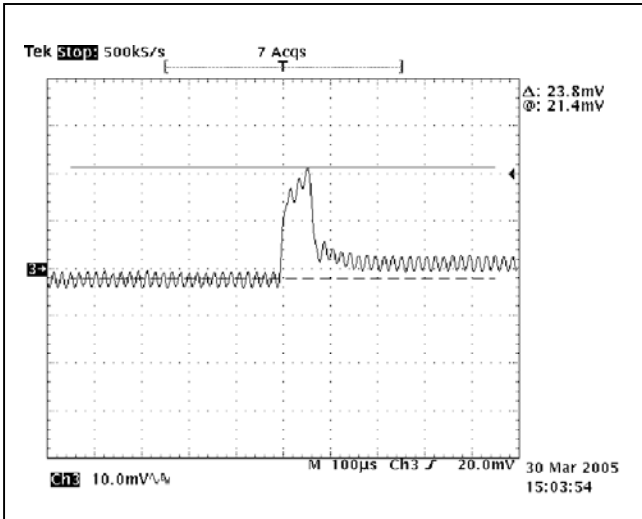

Figure 41. Transient Response at $T_A = 25^\circ\text{C}$, $1.8V_{OUT}$ Deviation (Hi-Lo).

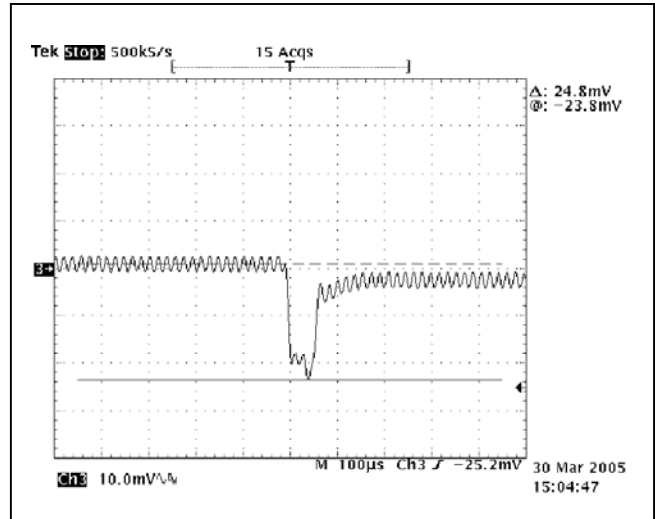

Figure 42. Transient Response at $T_A = 25^\circ\text{C}$, $1.8V_{OUT}$ Deviation (Lo-Hi).

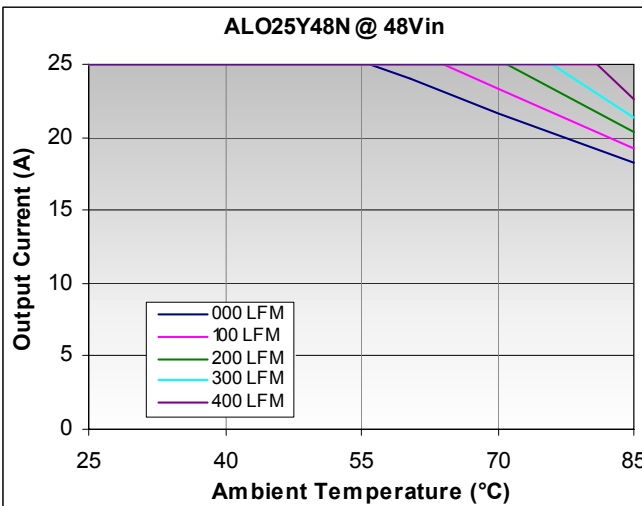

Figure 43. Output Current vs. Temperature for open frame version at $V_{IN} = 48V_{dc}$, $T_A = 25^\circ\text{C}$.

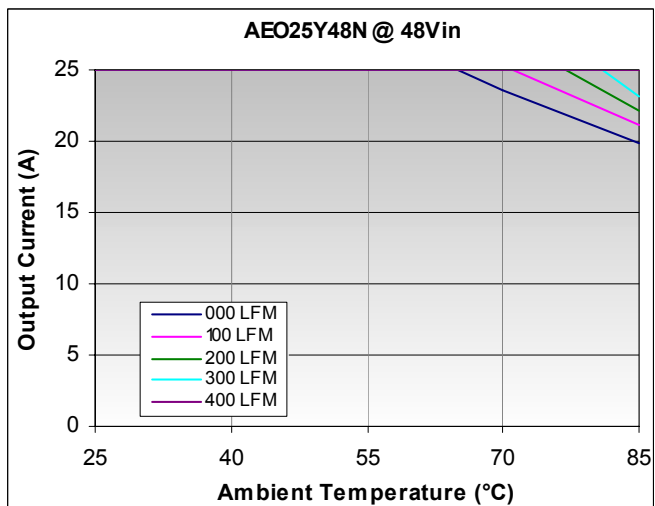

Figure 44. Output Current vs. Temperature for baseplate version at $V_{IN} = 48V_{dc}$, $T_A = 25^\circ\text{C}$.

Performance Curves

1.5V @ 25A

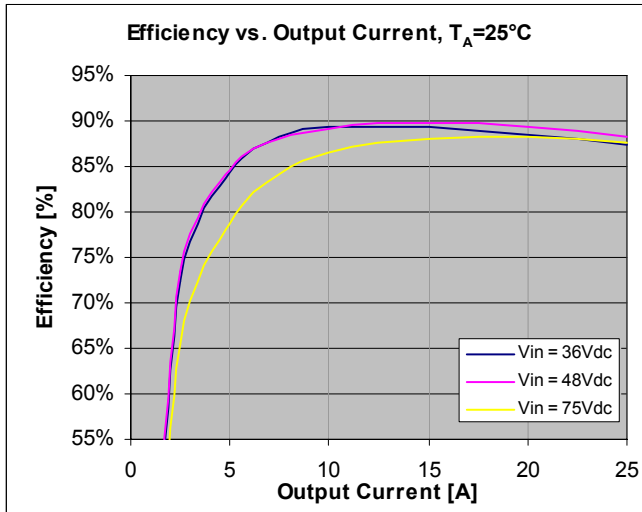

Figure 45. Efficiency vs. Load Current at $I_O = \text{Full Load}$, $T_A = 25^\circ\text{C}$ (ambient temperature).

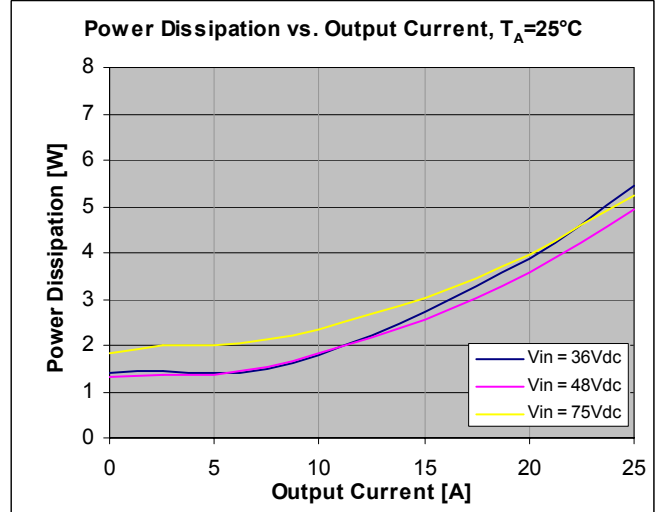

Figure 46. Power Dissipation vs. Load Current at $I_O = \text{Full Load}$, $T_A = 25^\circ\text{C}$ (ambient temperature).

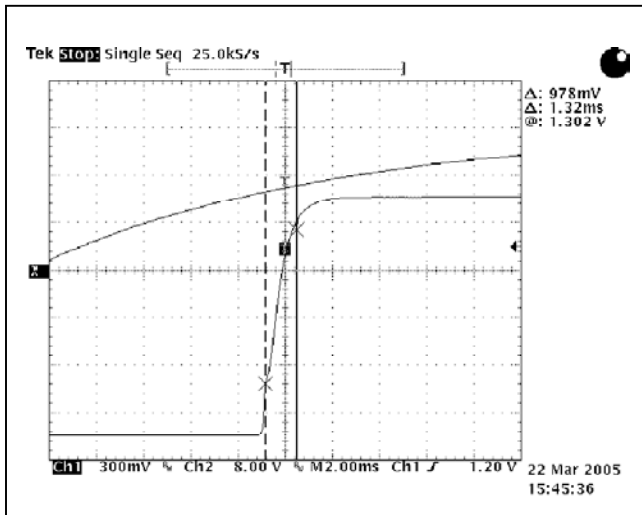

Figure 47. 1.5V_{OUT} Startup Characteristic at $V_{IN} = 48\text{Vdc}$, $I_O = \text{Full Load}$, $T_A = 25^\circ\text{C}$.

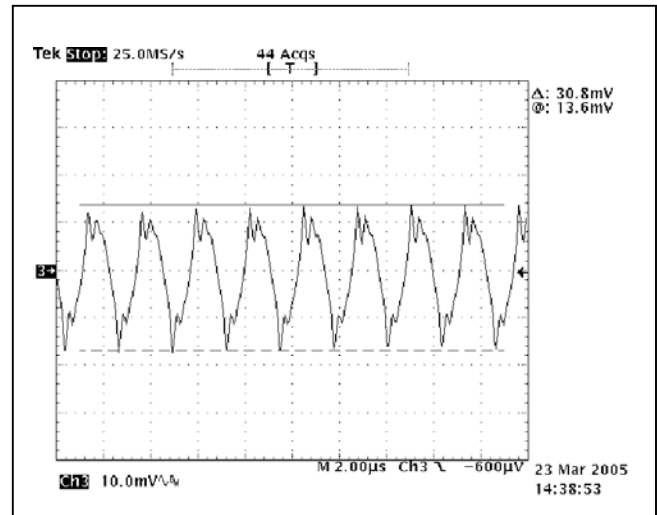

Figure 48. 1.5V_{OUT} Ripple Waveform at $V_{IN} = 48\text{Vdc}$, $I_O = \text{Full Load}$, $T_A = 25^\circ\text{C}$.

Performance Curves

1.5V @ 25A (continued)

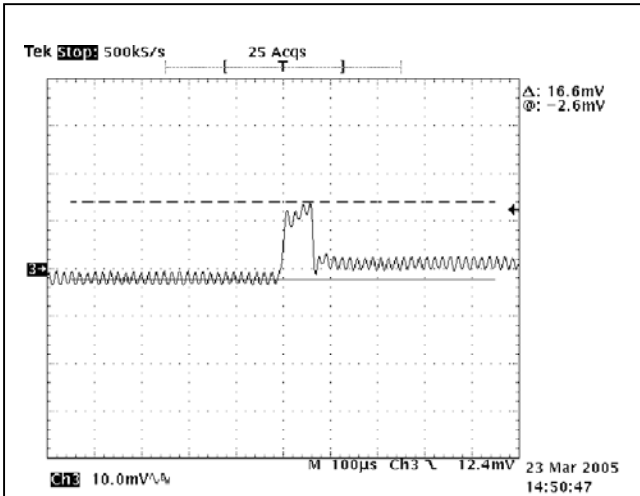

Figure 49. Transient Response at $T_A = 25^\circ\text{C}$, $1.5V_{\text{OUT}}$ Deviation (Hi-Lo).

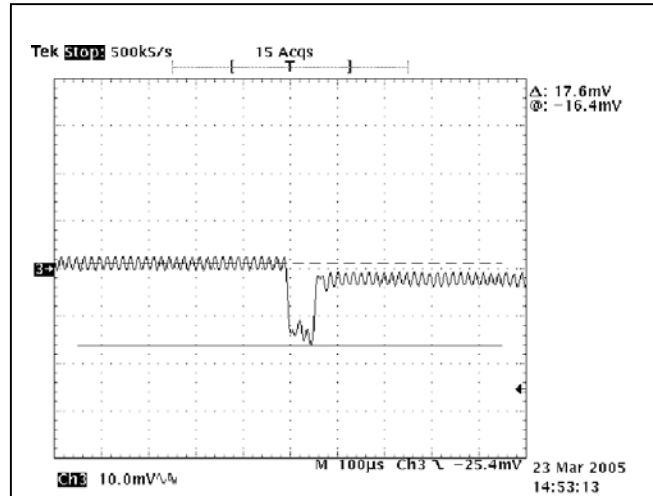

Figure 50. Transient Response at $T_A = 25^\circ\text{C}$, $1.5V_{\text{OUT}}$ Deviation (Lo-Hi).

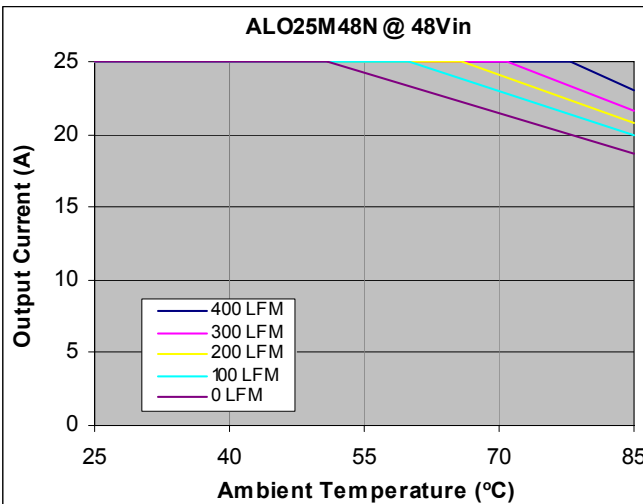

Figure 51. Output Current vs. Temperature for open frame version at $V_{\text{IN}} = 48\text{Vdc}$, $T_A = 25^\circ\text{C}$.

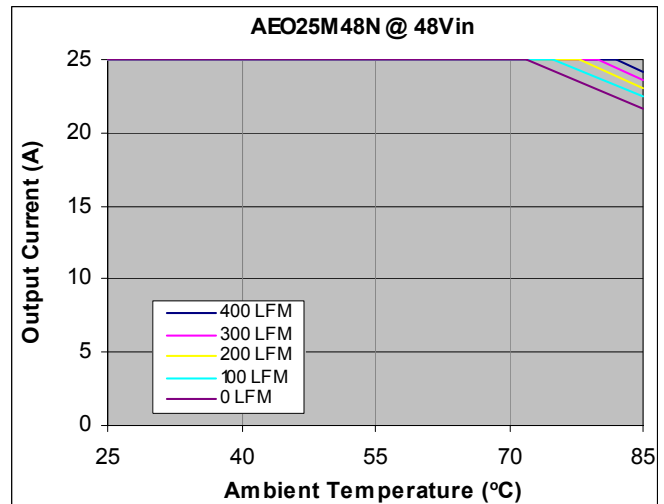

Figure 52. Output Current vs. Temperature for baseplate version at $V_{\text{IN}} = 48\text{Vdc}$, $T_A = 25^\circ\text{C}$.

Performance Curves

1.2V @ 25A

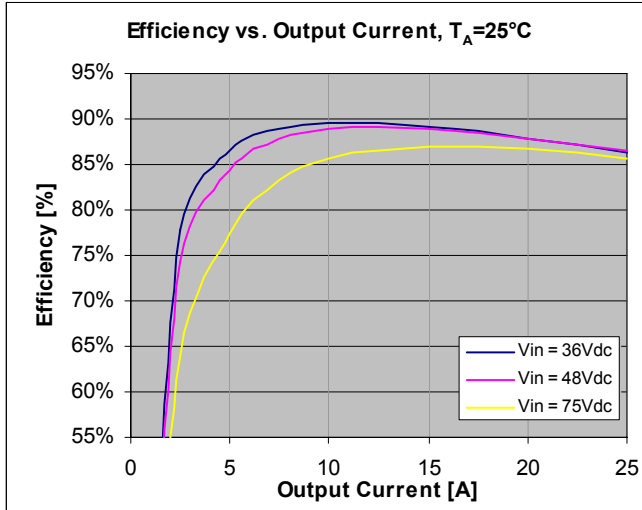

Figure 53. Efficiency vs. Load Current at $I_O = \text{Full Load}$, $T_A = 25^\circ\text{C}$ (ambient temperature).

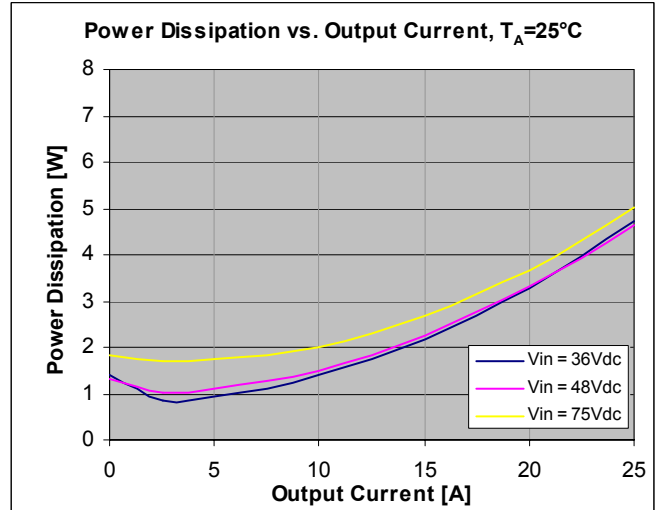

Figure 54. Power Dissipation vs. Load Current at $I_O = \text{Full Load}$, $T_A = 25^\circ\text{C}$ (ambient temperature).

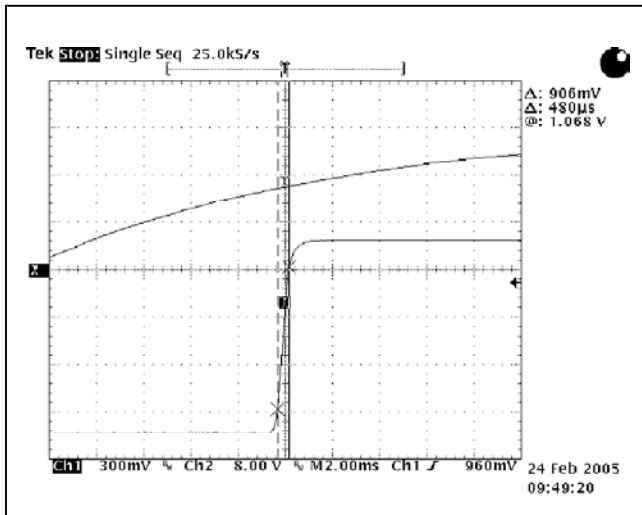

Figure 55. 1.2V_{OUT} Startup Characteristic at $V_{IN} = 48\text{Vdc}$, $I_O = \text{Full Load}$, $T_A = 25^\circ\text{C}$.

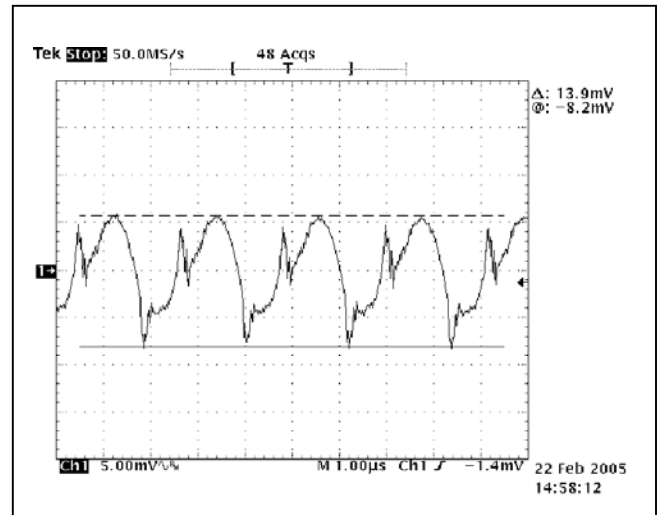

Figure 56. 1.2 V_{OUT} Ripple Waveform at $V_{IN} = 48\text{Vdc}$, $I_O = \text{Full Load}$, $T_A = 25^\circ\text{C}$.

Performance Curves

1.2 V @ 25A (continued)

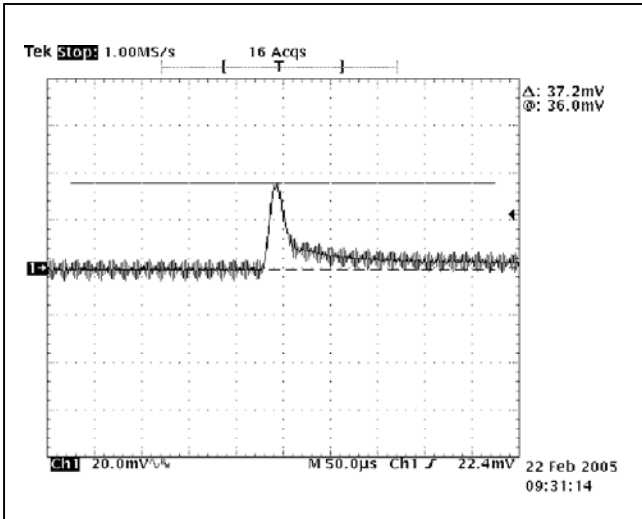

Figure 57. Transient Response at $T_A = 25^\circ\text{C}$, 1.2V_{OUT} Deviation (Hi-Lo).

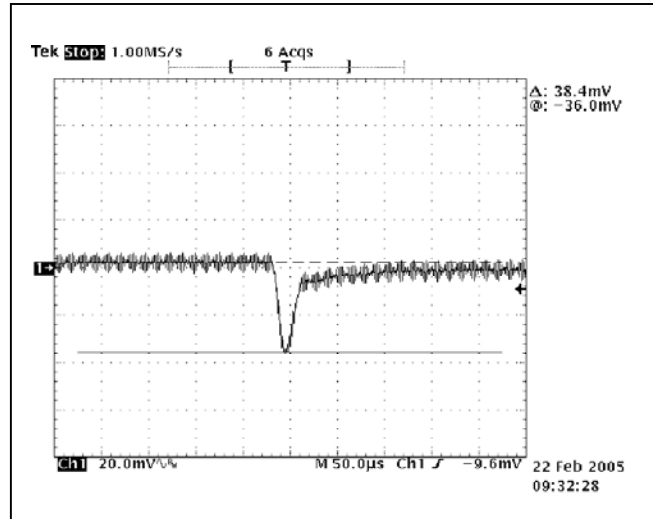

Figure 58. Transient Response at $T_A = 25^\circ\text{C}$, 1.2V_{OUT} Deviation (Lo-Hi).

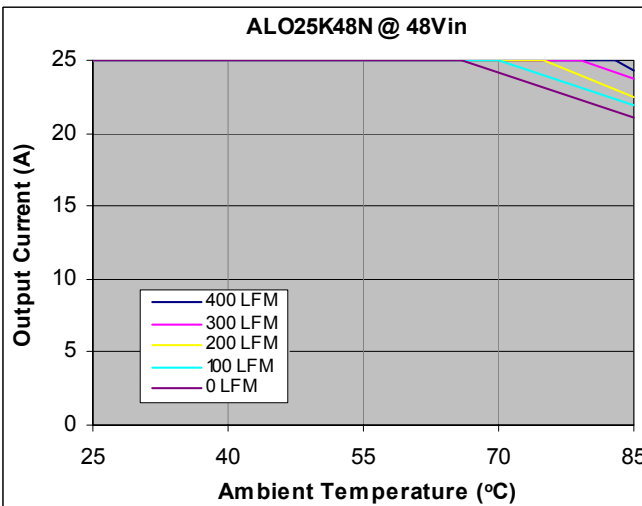

Figure 59. Output Current vs. Temperature for open frame version at $V_{IN} = 48\text{Vdc}$, $T_A = 25^\circ\text{C}$.

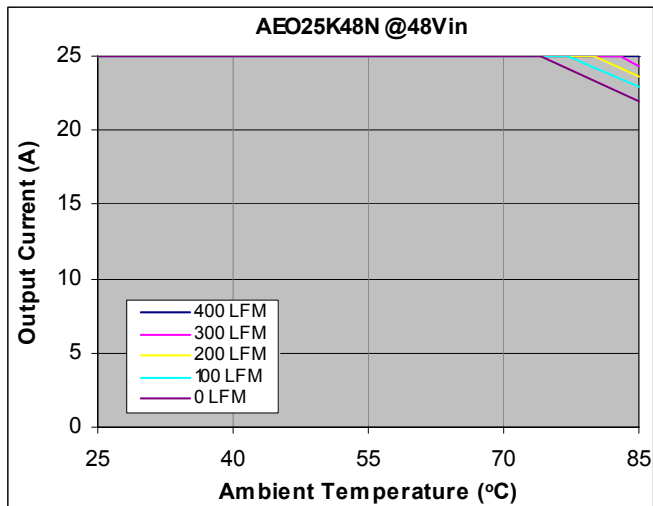

Figure 60. Output Current vs. Temperature for baseplate version at $V_{IN} = 48\text{Vdc}$, $T_A = 25^\circ\text{C}$.

Input Filter for FCC Class B Conducted Noise

A reference design for an input filter that can provide FCC Class B conducted noise levels is shown below (See Figure 61). Two common mode connected inductors are used in the circuit along with balanced bypass capacitors to shunt common mode currents into the ground plane. Shunting noise current back to the converter reduces the amount of energy reaching the input LISN for measurement.

The application circuit shown has an earth ground (frame ground) connected to the converter output (-) terminal. Such a configuration is common practice to accommodate safety agency requirements. Grounding an output terminal results in much higher conducted emissions as measured at the input LISN because a hard path for common mode current back to the LISN is created by the frame ground. “Floating” loads generally result in much lower measured emissions. The electrical equivalent of a floating load, for EMI measurement purposes, can be created by grounding the converter output (load) through a suitably sized inductor(s) while maintaining the necessary safety bonding.

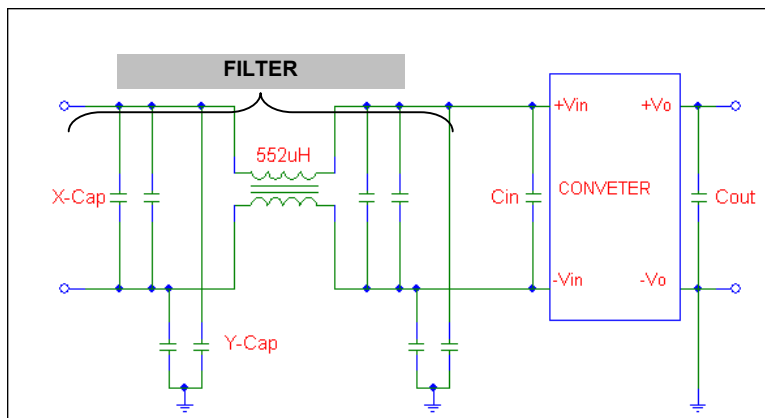

Figure 61: Class B Filter Circuit

PARTS LIST

CKT CODE	DESCRIPTION
Common Mode Choke	CTX01-15091 Cooper Electronic Technologies
X-Cap	0.47 μ F X 4pcs
Y-Cap	22 nF X 4 pcs
Cin	220 μ F X 1pc

Mechanical Specifications

Parameter	Device	Symbol	Min	Typ	Max	Unit
Dimension	All	L	-	2.30 [58.42]	-	in [mm]
		W	-	0.90 [22.90]	-	in [mm]
	AEO	H	-	-	0.40 [10.1]	in [mm]
	ALO	H	-	-	0.32 [8.2]	in [mm]
Weight	AEO		-	34.02 [1.2]	-	g [oz]
	ALO		-	22.68 [0.8]	-	g [oz]

PIN ASSIGNMENT

1	+V _{IN}	5	-SENSE
2	ENABLE	6	TRIM
3	-V _{IN}	7	+SENSE
4	-V _O	8	+V _O

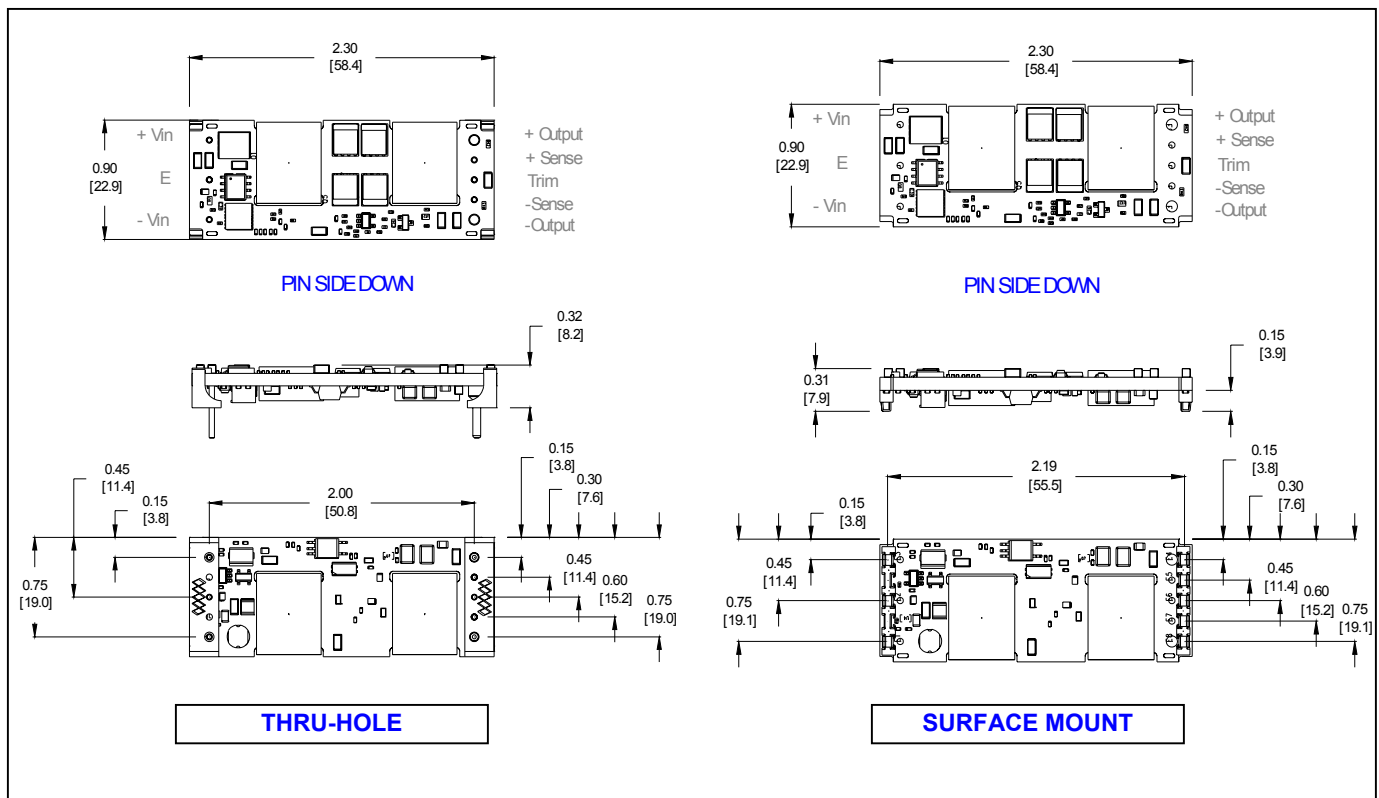

Figure 62A. ALO (Openframe) Mechanical outline.

Mechanical Specifications *(continued)*

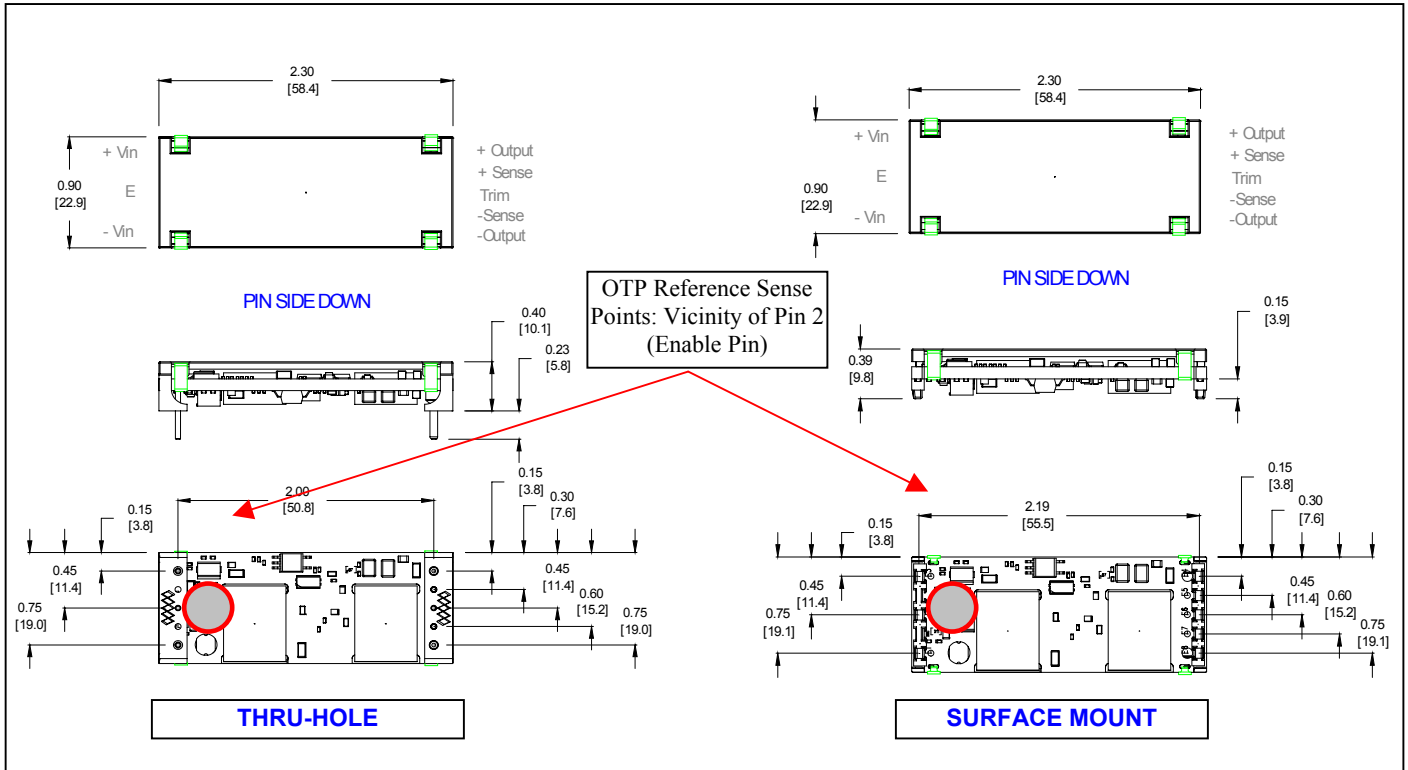

Figure 62B. (Baseplate) Mechanical Outline

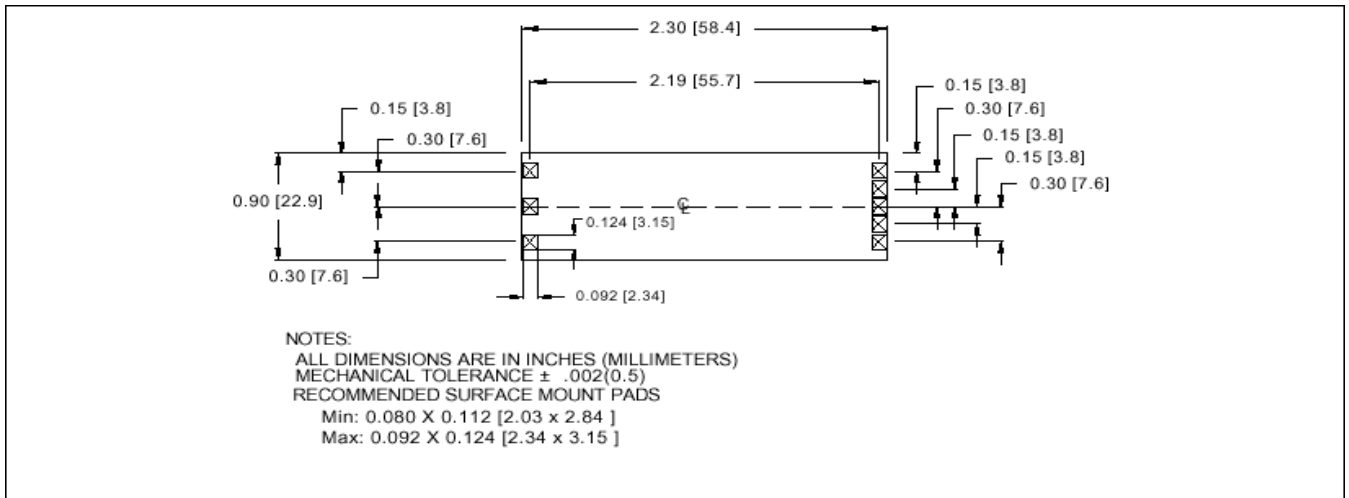

Figure 63. Recommended Pad layout for SMT (Suffix "S") version.



Technical Reference Notes

AEO_ALO04/12/20/25x48 Series (Single Output 8th Brick)



SOLDERING CONSIDERATIONS

The AEO (baseplate) series converters are compatible with standard wave soldering techniques. When wave soldering, the converter pins should be preheated for 20-30 seconds at 110°C and wave soldered at 260°C for less than 10 seconds.

When hand soldering, the iron temperature should be maintained at 425°C and applied to the converter pins for less than 5 seconds. Longer exposure can cause internal damage to the converter. Cleaning can be performed with cleaning solvent IPA or with water.

For SMT terminated modules, refer to Figure 64 for the recommended reflow profile.

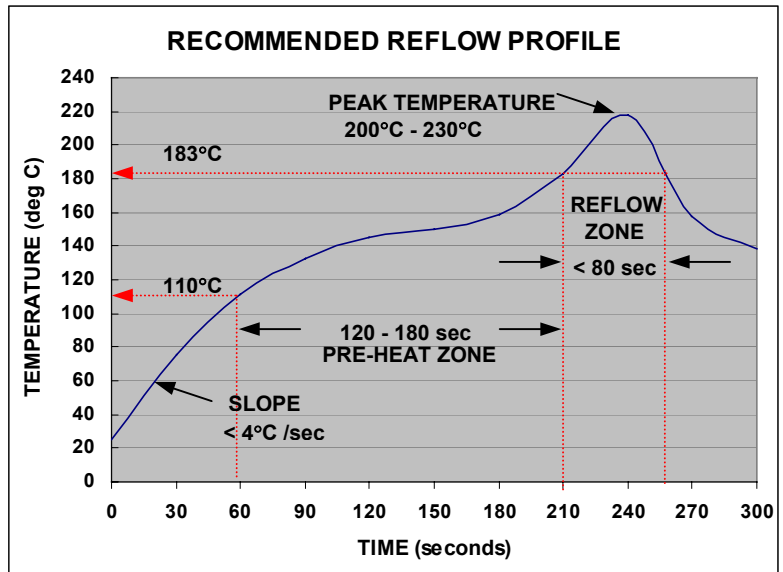

Figure 64. Recommended reflow profile for SMT modules.

TABLE 2: PART NUMBERING SCHEME

A	CONSTRUCTION	O	O/P CURRENT	O/P VOLTAGE	Vin	Enable	-	PIN LENGTH	TERMINATION
	w		xx	y	48	N	-	6	S
	L = Open frame E = Baseplate		04 = 4A 12 = 12A 20 = 20A 20 = 20A 25 = 25A 25 = 25A 25 = 25A	B =12V A =5V F =3.3V G =2.5V Y =1.8V M =1.5V K =1.2V		N = Negative Blank = Positive		6 = 3.7mm blank = 5mm default	S = SMT Termination Blank = thru-hole

Note: 1) For Through Hole termination: - Std pin length is 5mm nominal (min: 0.189 [4.8]; max: 0.205 [5.2] / in [mm])
 - “-6” option is 3.7mm nominal (min: 0.137 [3.5]; max: 0.152 [3.9] / in [mm])
 - Pins 4&8 diameter: $\varnothing = 0.062$ [1.57], others: $\varnothing = 0.04$ [1.0] (6X)

Please call 1-888-41-ASTEC for further inquiries or visit us at www.astecpower.com