



HJ2584

PNP EPITAXIAL PLANAR TRANSISTOR

Description

The HJ2584 is designed for use in low voltage and low drop out regulator applications.

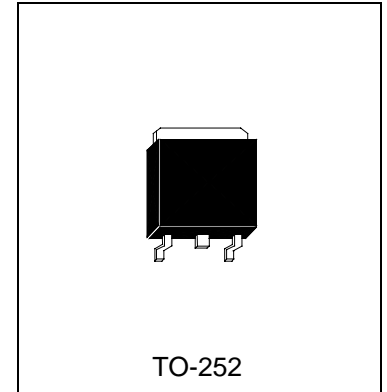

Absolute Maximum Ratings (Ta=25°C)

- Maximum Temperatures
 - Storage Temperature -55 ~ +150 °C
 - Junction Temperature +150 °C
- Maximum Power Dissipation
 - Total Power Dissipation (Tcase=25°C)..... 20 W
- Maximum Voltages and Currents
 - BVCBO Collector to Base Voltage..... -35 V
 - BVCEO Collector to Emitter Voltage..... -35 V
 - BVEBO Emitter to Base Voltage..... -5 V
 - IC Collector Current..... -10 A

Characteristics (Ta=25°C)

Symbol	Min.	Typ.	Max.	Unit	Test Conditions
BVCEO	-35	-	-	V	IC=-100uA
ICBO	-	-	-10	uA	VCB=-20V
ICEO	-	-	-20	uA	VCE=-15V
IEBO	-	-	-2	mA	VEB=-5V
*VCE(sat)	-	-	-1.5	V	IC=-10A, IB=-10mA
*VBE(on)	-	-	-2	V	IC=-5A, VCE=-1.7V
*hFE1	2	-	60	K	IC=-500mA, VCE=-1.7V
*hFE2	1	15	60	K	IC=-10A, VCE=-1.7V

*Pulse Test: Pulse Width ≤380us, Duty Cycle≤2%



Characteristics Curve

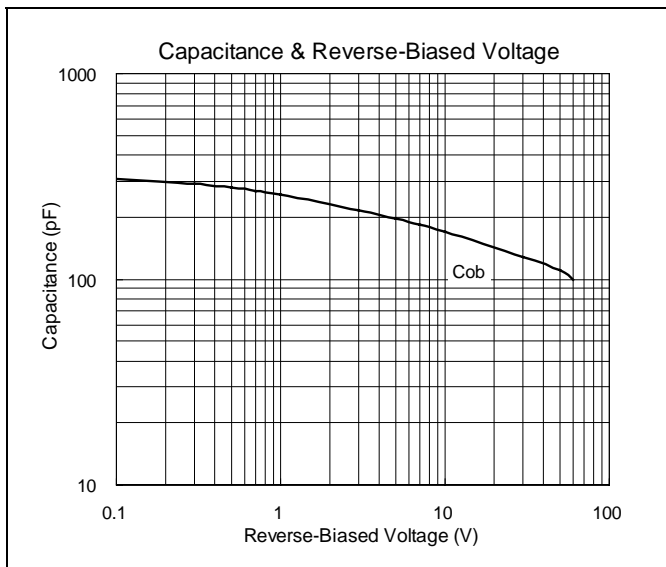
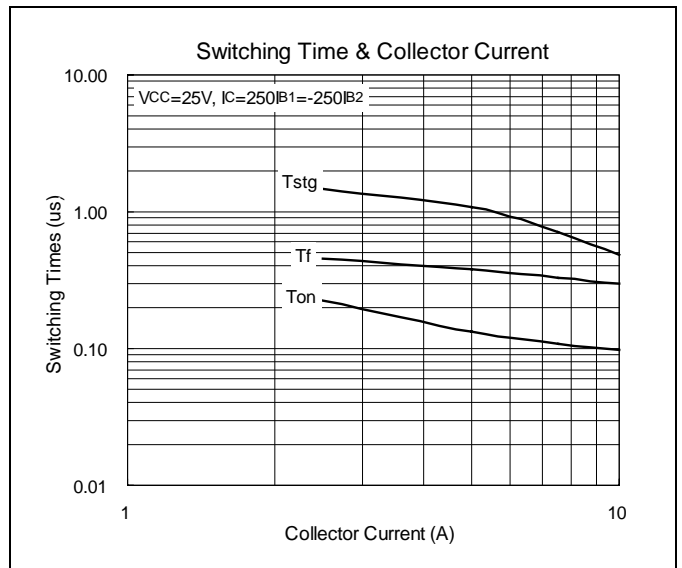
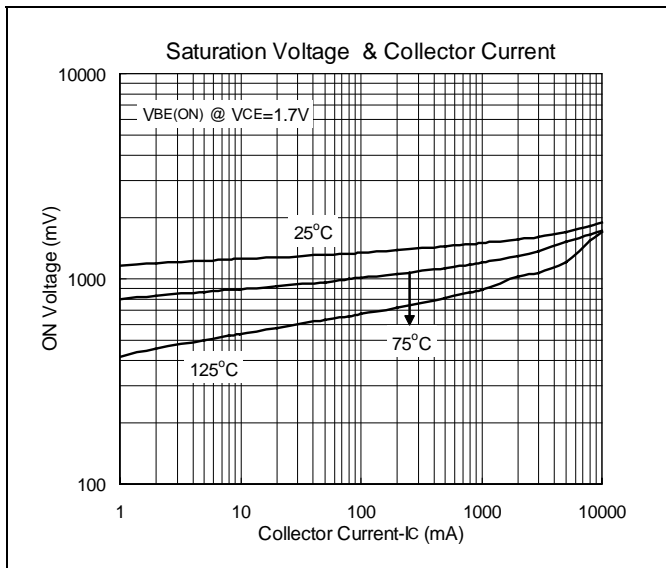
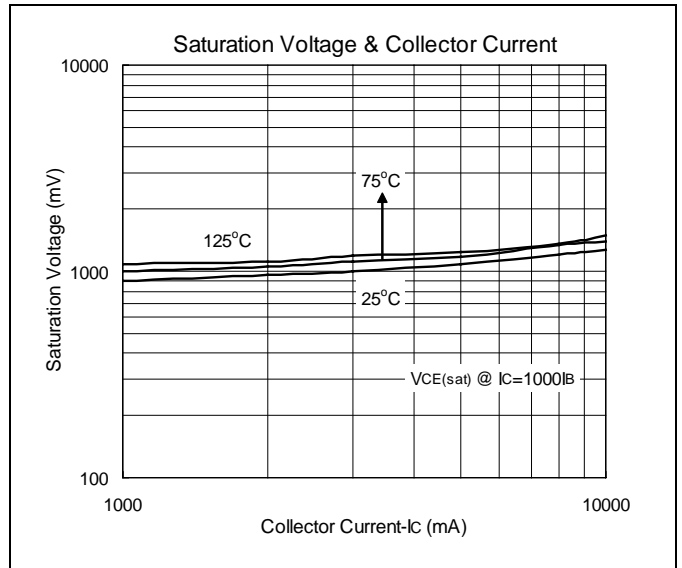
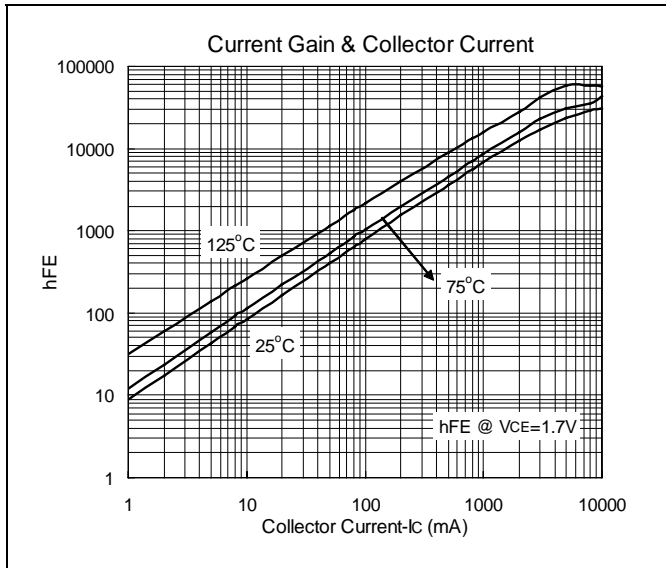



TO-252 Dimension

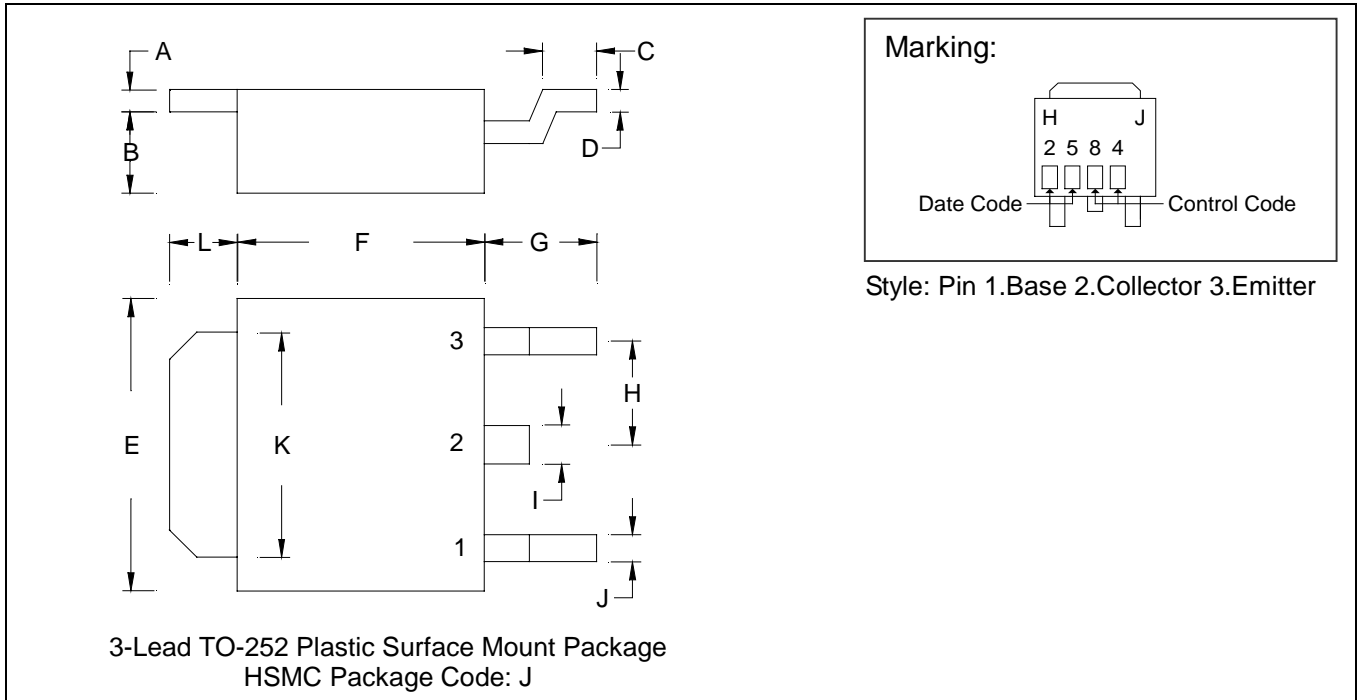

*: Typical

DIM	Inches		Millimeters		DIM	Inches		Millimeters	
	Min.	Max.	Min.	Max.		Min.	Max.	Min.	Max.
A	0.0177	0.0217	0.45	0.55	G	0.0866	0.1102	2.20	2.80
B	0.0650	0.0768	1.65	1.95	H	-	*0.0906	-	*2.30
C	0.0354	0.0591	0.90	1.50	I	-	0.0354	-	0.90
D	0.0177	0.0236	0.45	0.60	J	-	0.0315	-	0.80
E	0.2520	0.2677	6.40	6.80	K	0.2047	0.2165	5.20	5.50
F	0.2125	0.2283	5.40	5.80	L	0.0551	0.0630	1.40	1.60

- Notes: 1.Dimension and tolerance based on our Spec. dated May. 05,1996.
 2.Controlling dimension: millimeters.
 3.Maximum lead thickness includes lead finish thickness, and minimum lead thickness is the minimum thickness of base material.
 4.If there is any question with packing specification or packing method, please contact your local HSMC sales office.

Material:

- Lead: 42 Alloy; solder plating
- Mold Compound: Epoxy resin family, flammability solid burning class: UL94V-0

Important Notice:

- All rights are reserved. Reproduction in whole or in part is prohibited without the prior written approval of HSMC.
- HSMC reserves the right to make changes to its products without notice.
- **HSMC semiconductor products are not warranted to be suitable for use in Life-Support Applications, or systems.**
- HSMC assumes no liability for any consequence of customer product design, infringement of patents, or application assistance.

Head Office And Factory:

- **Head Office** (Hi-Sincerity Microelectronics Corp.): 10F.,No. 61, Sec. 2, Chung-Shan N. Rd. Taipei Taiwan R.O.C.
 Tel: 886-2-25212056 Fax: 886-2-25632712, 25368454
- **Factory 1:** No. 38, Kuang Fu S. Rd., Fu-Kou Hsin-Chu Industrial Park Hsin-Chu Taiwan. R.O.C
 Tel: 886-3-5983621~5 Fax: 886-3-5982931