

PLEASE CHECK WWW.MOLEX.COM FOR LATEST PART INFORMATION

Part Number: [0522710769](#)
Status: **Active**
Description: 1.00mm (.039") Pitch FFC/FPC Connector, Right Angle, SMT, ZIF, Bottom Contact Style, 7 Circuits, Lead-free, Gold Contact Plating

Documents:

[3D Model](#) [Product Specification PS-52271-054 \(PDF\)](#)
[Drawing \(PDF\)](#) [RoHS Certificate of Compliance \(PDF\)](#)

General

Product Family FFC/FPC Connectors
 Series [52271](#)
 Product Name N/A

Physical

Circuits (Loaded) 7
 Color - Resin Natural
 Contact Position Bottom
 Durability (mating cycles max) 30
 Entry Angle 90° Angle
 Flammability 94V-0
 Mated Height (in) 0.118 In
 Mated Height (mm) 3.00 mm
 Material - Metal Phosphor Bronze
 Material - Plating Mating Gold
 Material - Plating Termination Tin
 Material - Resin Nylon
 Number of Rows 1
 Orientation Right Angle
 PCB Locator No
 PCB Retention Yes
 Packaging Type Embossed Tape on Reel
 Pitch - Mating Interface (in) 0.039 In
 Pitch - Mating Interface (mm) 1.00 mm
 Polarized to PCB Yes
 Stackable No
 Temperature Range - Operating -20°C to +85°C
 Termination Interface: Style Surface Mount
 Wire/Cable Type FFC/FPC

Electrical

CSA LR19980
 Current - Maximum 0.5A
 UL E29179
 Voltage - Maximum 50V AC (RMS)/DC

Material Info

Reference - Drawing Numbers

Product Specification PS-52271-054
 Product Specification RPS-52271-076
 Product Specification RPS-52271-078
 Product Specification RPS-52271-079
 Product Specification RPS-52271-081
 Product Specification RPS-52271-082
 Product Specification RPS-52271-083
 Product Specification RPS-52271-084
 Product Specification RPS-52271-086

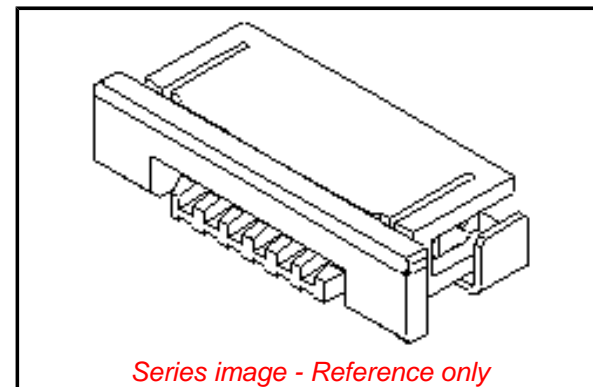

Series image - Reference only

EU RoHS

**ELV and RoHS
 Compliant**
**REACH SVHC
 Contains SVHC: No**
**Halogen-Free
 Status
 Not Reviewed**

China RoHS



**Need more information on product
 environmental compliance?**

Email productcompliance@molex.com
 Please visit the [Contact Us](#) section for any
 non-product compliance questions.

Search Parts in this Series
[52271 Series](#)

Product Specification
Product Specification
Sales Drawing
Sales Drawing

RPS-52271-088
RPS-52271-090
SD-52271-038
SD-52271-039

This document was generated on 11/05/2009

PLEASE CHECK WWW.MOLEX.COM FOR LATEST PART INFORMATION