

The products listed in this catalog are only a few of the thousands of variations that TUSONIX produces. For custom component design, please contact the factory direct.

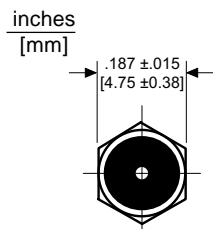

#8-32 UNC-2A Pi, C & L Filters and Feed-Thru Capacitors



STYLE 1

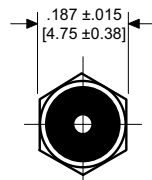
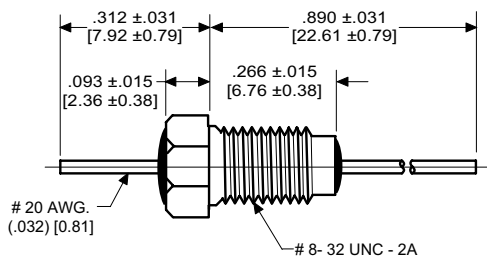

STYLE 2

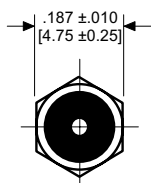
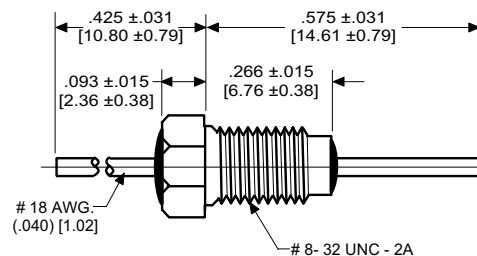

STYLE 3

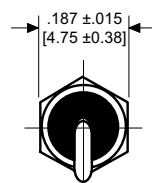
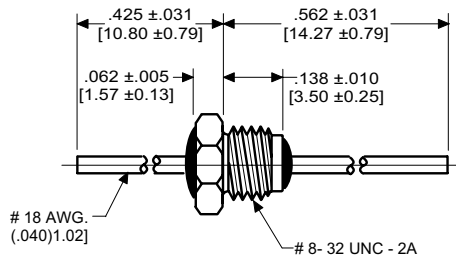

STYLE 4

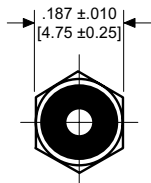
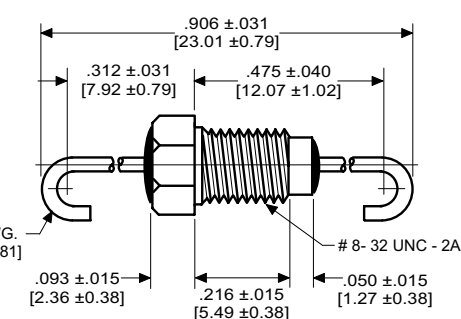

STYLE 5

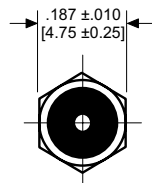
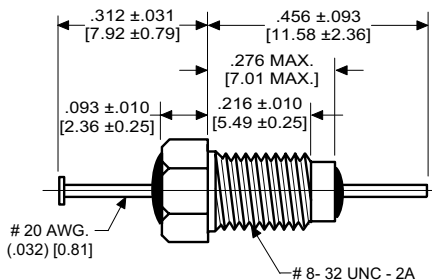

STYLE 6

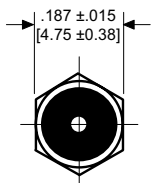
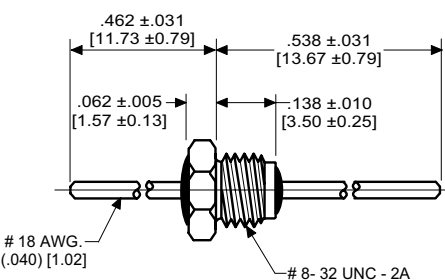

STYLE 7

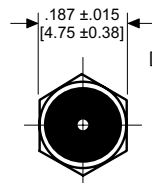
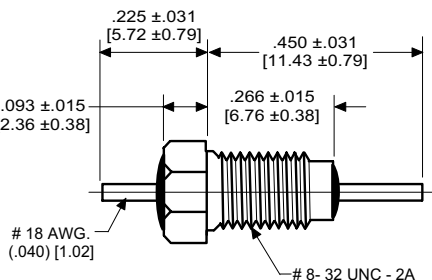

STYLE 8

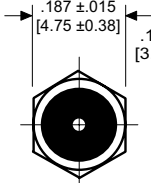
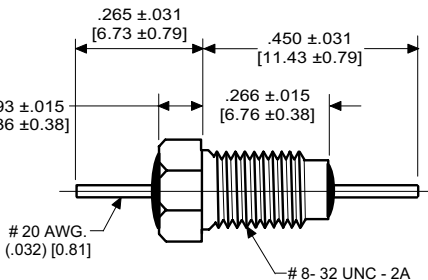

STYLE 9

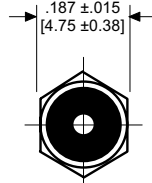
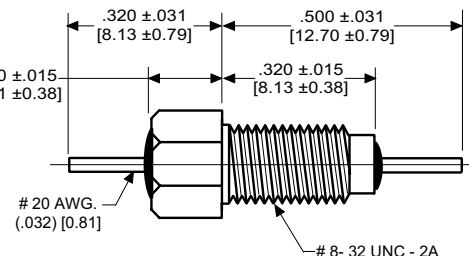

STYLE 10

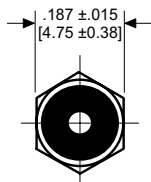
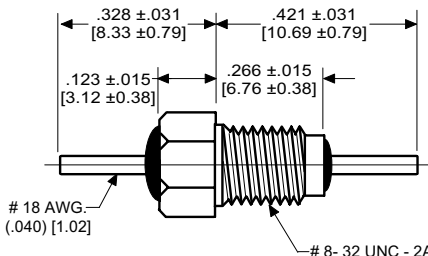

STYLE 11

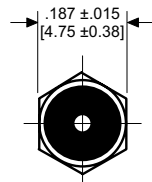
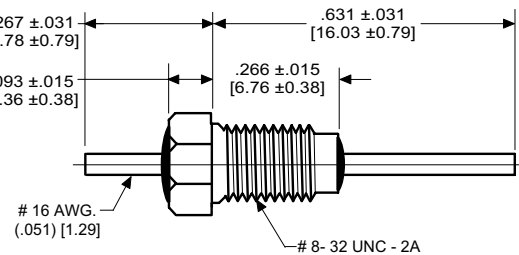

STYLE 12

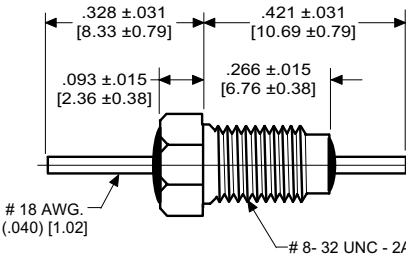

#8-32 UNC-2A Pi, C & L Filters and Feed-Thru Capacitors

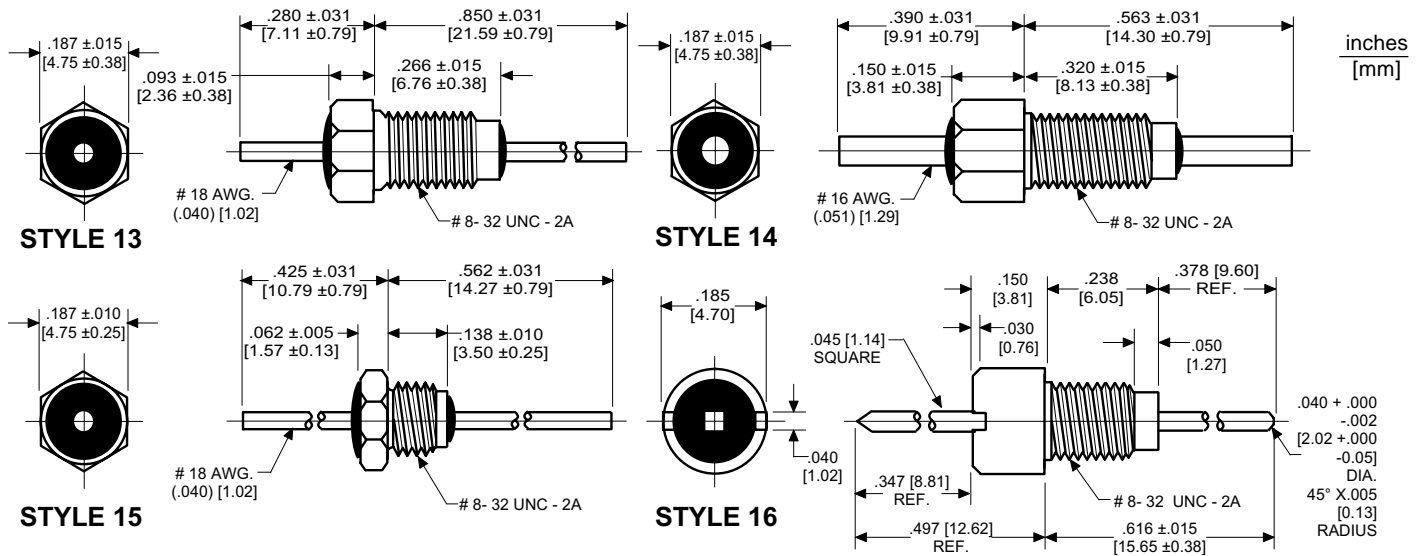

Series Number	Temperature Range	WVdc	MAX. Cap. (Nominal) (pF)
2425	Z5, Y5, X5	200	10,000
	X7	100	10,000

Notes:

- ◆ Turret Lead
- ▽ #18 AWG Lead 0.040 Dia.
- Typical Insertion Loss
- No hex nut or Lockwasher

Please see Temperature Characteristics and EIA Codes on page 25.

TUSONIX Part Number	MIL-PRF-15733 Number	Style	Notes	Circuit	Working Voltage (dc)		Capacitance (pF)	Capacitance Tolerance	Current (A)	Minimum No-Load Insertion Loss (dB) at 25°C per MIL-Std-220							
					85°C	125°C				1MHz	10MHz	100MHz	1GHz	10GHz			
Pi Configuration																	
4251-001	--	8	--	Pi	--	50	15,000	GMV	10	5	18	65	70	--			
4201-048	--	16	□	Pi	200	100	100	GMV	15	--	--	5	32	--			
4201-047	--	16	□	Pi	200	100	1000	GMV	15	--	4	37	60	--			
4201-502	/61-0008	5	--	Pi	--	100	1000	GMV	10	--	--	65	70	70			
4201-000	--	1	--	Pi	200	100	1500	GMV	10	--	5	45	65	70			
4201-001	--	1	◆	Pi	200	100	1500	GMV	10	--	5	45	65	70			
4201-004	--	1	▽	Pi	200	100	1500	GMV	15	--	5	38	63	70			
4201-006	--	1	◆▽	Pi	200	100	1500	GMV	15	--	5	38	63	70			
4201-501	/28-0001	1	◆	Pi	--	100	1500	GMV	10	--	--	45	60	60			
4201-503	/28-0002	4	--	Pi	--	100	1500	GMV	10	--	--	45	60	60			
4201-003	--	2	--	Pi	200	100	2000	GMV	15	--	5	38	63	70			
4201-050	--	1	--	Pi	200	100	5500	GMV	10	--	14	55	70	70			
4201-051	--	1	◆	Pi	200	100	5500	GMV	10	--	14	55	70	70			
4201-053	--	1	◆▽	Pi	200	100	5500	GMV	15	--	14	55	65	65			
4201-083	--	9	--	Pi	200	100	10,000	+80-20%	10	--	18	65	70	70			
4251-004	--	9	--	Pi	100	100	28,000	GMV	10	10	38	75	75	75			
4205-002	--	3	--	Pi	250	125	65	+100-0%	15	--	--	3	16	45			
4205-018	--	6	--	Pi	250	125	65	+100-0%	15	--	--	3	16	45			
4205-017	--	6	--	Pi	250	125	1500	GMV	15	--	5	35	60	60			
4205-001	--	15	--	Pi	250	125	1500	GMV	15	--	5	35	60	60			
4251-000	--	7	--	Pi	185	125	3000	+100-0%	15	--	10	30	65	65			
4251-002	--	9	--	Pi	200	125	12,000	GMV	10	5	28	65	70	70			
C Configuration																	
2425-018-X5U0-101M	--	11	●●◆	C	200	100	100	±20%	20	--	--	3	20	28			
2425-544-X7R0-101M	--	11	●●◆	C	200	100	100	±20%	20	--	--	3	20	28			
2425-018-X5U0-102M	--	11	●●◆	C	200	100	1000	±20%	20	--	3	20	35	40			
2425-544-X7R0-102P	--	11	●●◆	C	200	100	1000	+100-0%	20	--	3	20	35	40			
2425-018-X5W0-502M	--	11	●●◆	C	200	100	5000	±20%	20	--	15	30	45	50			
2425-601-X5W0-103Z	--	14	●●◆	C	200	100	10,000	+80-20%	20	--	20	35	50	55			
4404-001	--	1	◆	C	100	100	27,000	GMV	10	10	30	45	55	--			
4404-002	--	12	--	C	140	100	50,000	GMV	10	15	34	45	60	--			
4404-003	--	10	--	C	--	100	100,000	GMV	10	20	38	47	65	--			
L Configuration																	
4404-050	--	13	--	L	--	100	22,000	GMV	10	7	27	43	60	--			

Drawings not to scale.

Please Note: All bushing style filters include hex nut and lock washer unless otherwise noted.