

Features

- 1.6 dB Noise Figure
- Single +4 V Bias @ 60 mA
- Fully internally matched to 50 Ω
- Lead-Free 3 mm 16-Lead PQFN Package
- Halogen-Free “Green” Mold Compound
- RoHS* Compliant and 260°C Reflow Compatible

Description

The MAAL-010528 is a high performance X-band GaAs LNA, housed in a miniature, lead-free 3 mm PQFN surface mount plastic package. This MMIC operates from 8 to 12 GHz providing a nominal gain of 20 dB with excellent gain flatness, high OIP3 linearity of 26 dBm, and a mid-band noise figure of 1.6 dB. The part features a self-bias architecture which requires only a single, positive supply. The device is internally matched to 50 Ω input/ output and is well suited to multiple applications including Vsat, radar and microwave radios due to the part's ease of use and excellent performance parameters.

Ordering Information ^{1,2}

Part Number	Package
MAAL-010528-TR0500	500 piece reel
MAAL-010528-001SMB	Sample Board

1. Reference Application Note M513 for reel size information.
2. All sample boards include 5 loose parts.

* Restrictions on Hazardous Substances, European Union Directive 2002/95/EC.

Functional Schematic

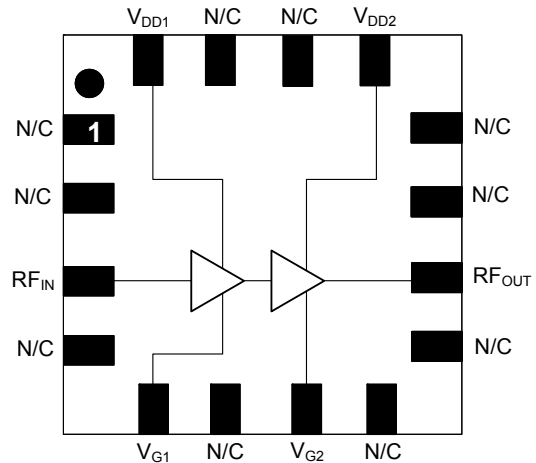

Pin Configuration

Pin No.	Pin Name	Description
1	N/C	No Connection
2	N/C	No Connection
3	RF _{IN}	RF Input
4	N/C	No Connection
5 ^{3,4}	V _{G1}	Gate Voltage 1
6	N/C	No Connection
7 ^{3,4}	V _{G2}	Gate Voltage 2
8	N/C	No Connection
9	N/C	No Connection
10	RF _{OUT}	RF Output
11	N/C	No Connection
12	N/C	No Connection
13	V _{DD2}	Bias Voltage 2
14	N/C	No Connection
15	N/C	No Connection
16	V _{DD1}	Bias Voltage 1
Paddle ⁵	RF and DC Ground	

3. For self-bias, external components C7 through C12 are optional. No V_G bias is needed. If C7 through C12 are removed, traces must also be removed.
4. For optional adjustment of self-bias, apply D.C. gate voltage between -1 V and +0.3 V. External components C7 through C12 are required.
5. The exposed pad centered on the package bottom must be connected to RF and DC ground.

Electrical Specifications: $T_A = 25^\circ\text{C}$, $V_{DD} = 4\text{ V}$, $Z_0 = 50\ \Omega$

Parameter	Test Conditions	Units	Min.	Typ.	Max.
Gain	8 - 12 GHz	dB	17.5	20	—
Noise figure	8 GHz 10 GHz 12 GHz	dB	—	1.5 1.8 2.1	2.0 2.3 2.8
Input Return Loss	8 - 12 GHz	dB	—	10	—
Output Return Loss	8 - 12 GHz	dB	—	13	—
P1dB	8 - 12 GHz	dBm	—	14	—
OIP3	8 - 12 GHz	dBm	—	26	—
Current	—	mA	—	60	75

Absolute Maximum Ratings^{6,7}

Parameter	Absolute Maximum
Input Power	+22 dBm
Operating Voltage	6 V
Operating Temperature	-40°C to +85°C
Storage Temperature	-65°C to +150°C

6. Exceeding any one or combination of these limits may cause permanent damage to this device.
7. M/A-COM Technology Solutions does not recommend sustained operation near these survivability limits.

Handling Procedures

Please observe the following precautions to avoid damage:

Static Sensitivity

Gallium Arsenide Integrated Circuits are sensitive to electrostatic discharge (ESD) and can be damaged by static electricity. Proper ESD control techniques should be used when handling these HBM Class 1B devices.

Recommended PCB

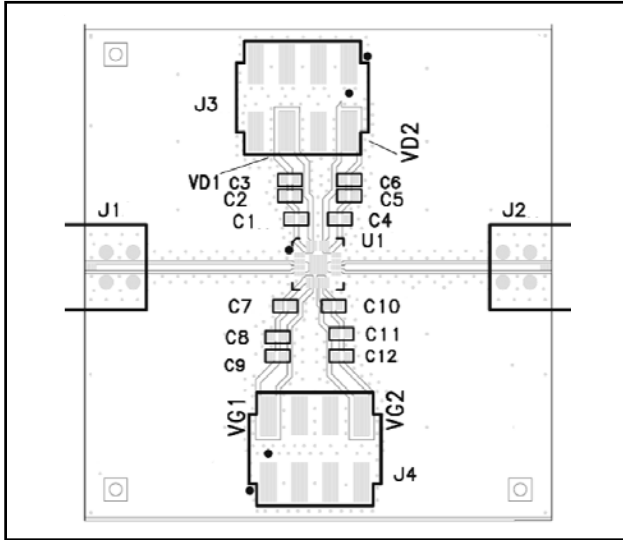

Parts List

Component	Value	Package
C1, C4, C7, C10	2.2 pF	0402
C2, C5, C8, C11	100 pF	0402
C3, C6, C9, C12	0.01 μ F	0402

Application Schematic^{8,9}

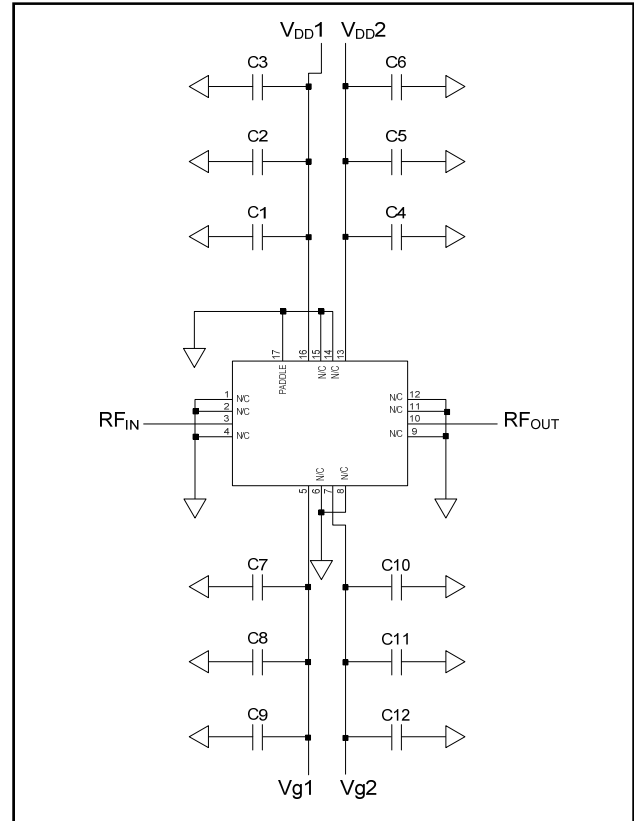

- For self-bias, external components C7 through C12 are optional. No V_G bias is needed. If C7 through C12 are removed, traces must also be removed.
- For optional adjustment of self-bias, apply D.C. gate voltage between -1 V and $+0.3$ V. External components C7 through C12 are required.

Typical Performance Curves

Wide-Band Gain and Return Loss

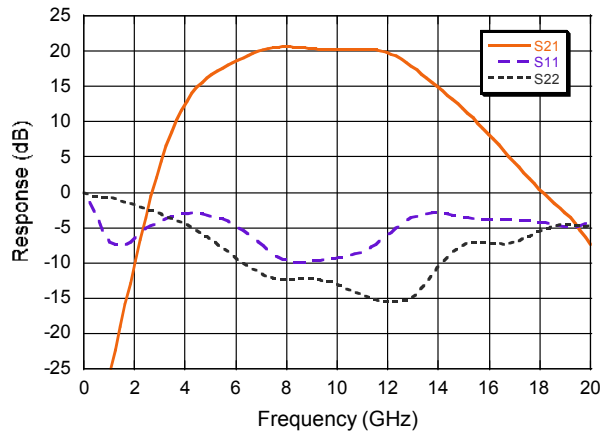

Small-Signal Gain vs. Temperature

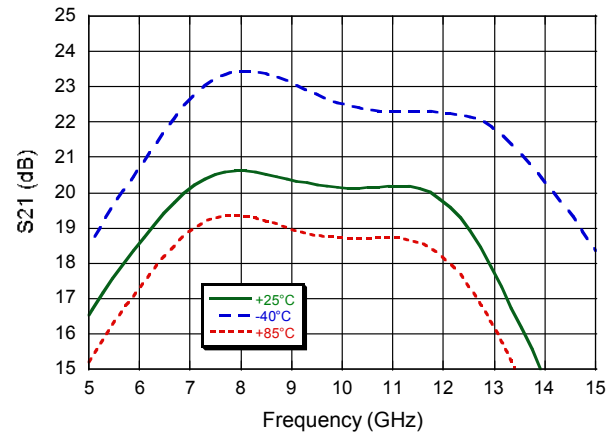

Input Return Loss vs. Temperature

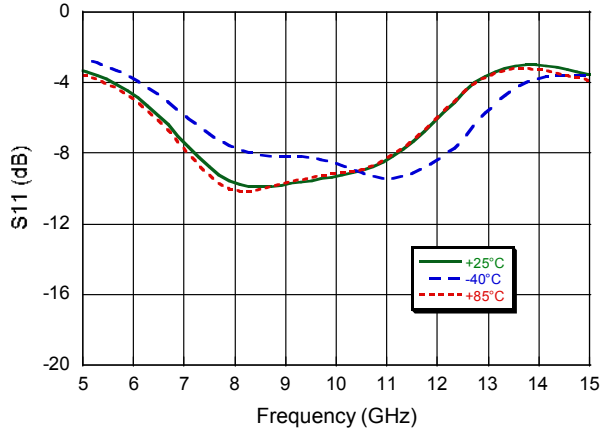

Output Return Loss vs. Temperature

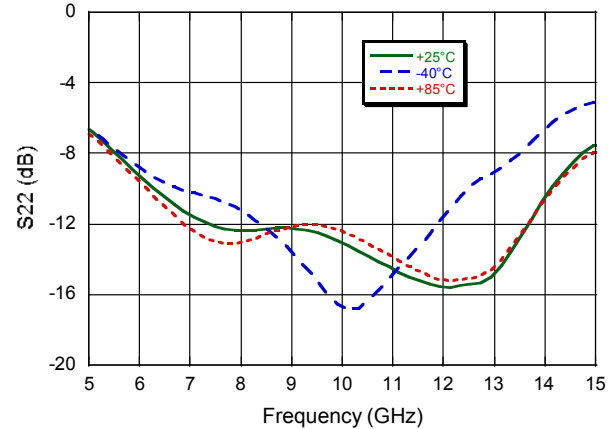

Noise Figure vs. Temperature

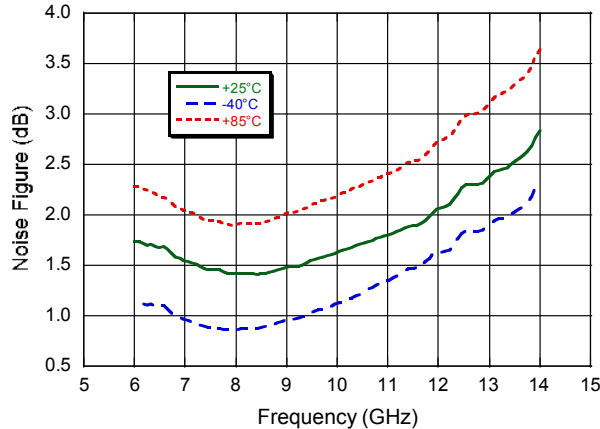

Noise Figure vs. Supply Voltage

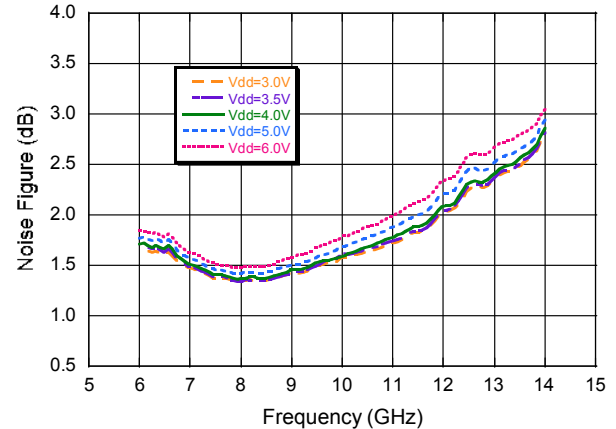

Typical Performance Curves

Small-Signal Gain vs. Supply Voltage

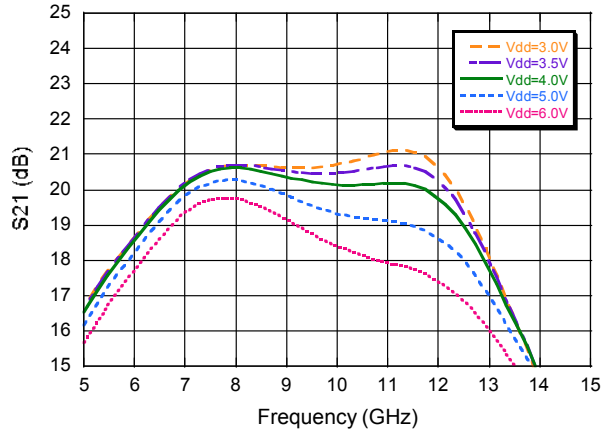

Input Return Loss vs. Supply Voltage

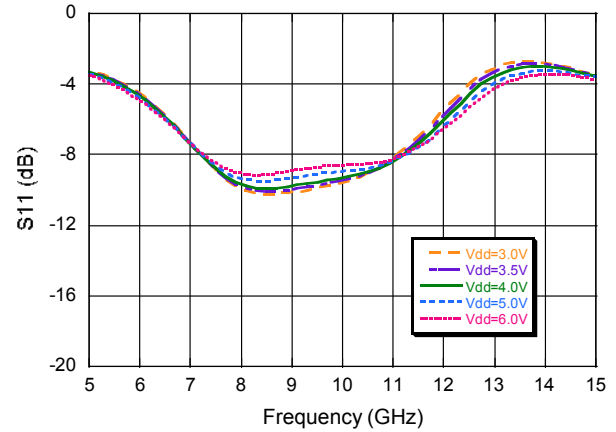

Output Return Loss vs. Supply Voltage

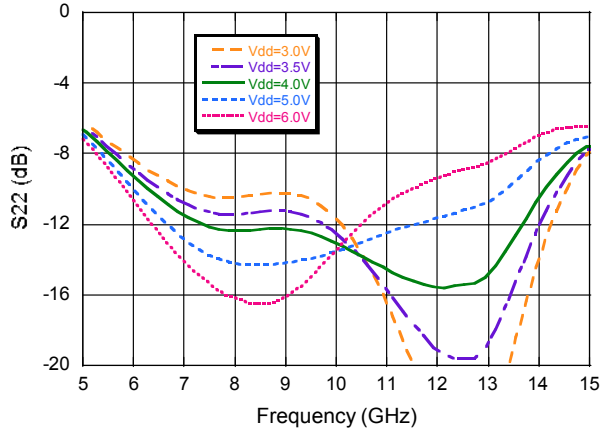

P1dB vs. Temperature

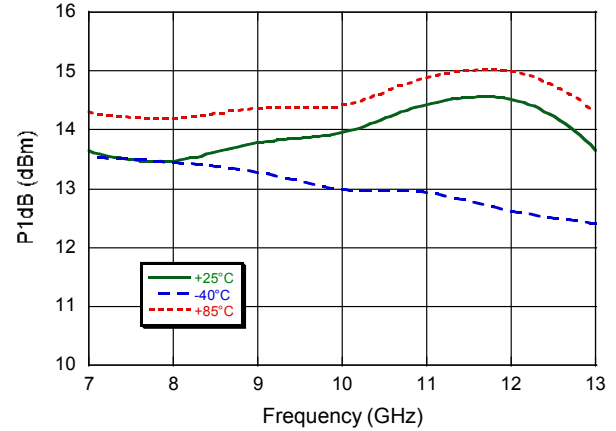

Large-Signal Gain vs. Voltage @ 10 GHz

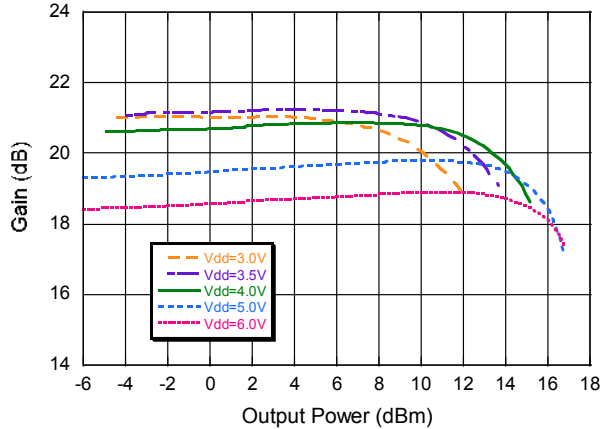

Large-Signal Gain vs. Temperature @ 10 GHz

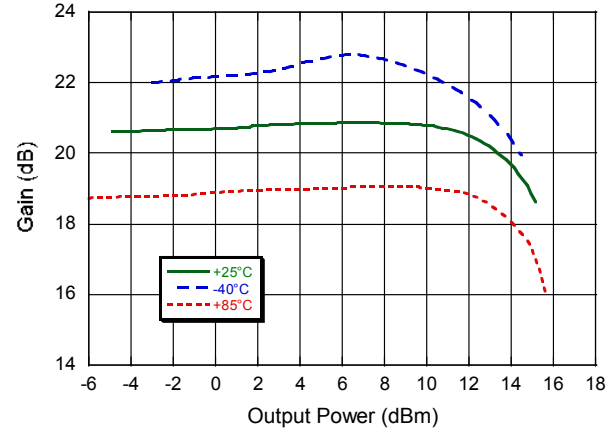

Typical Performance Curves

Output IP3 vs. Supply Voltage

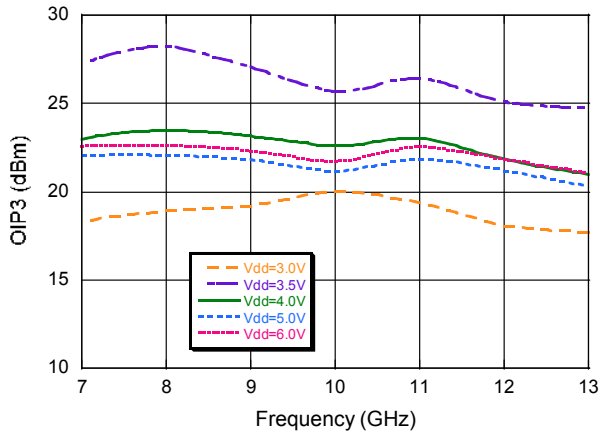

Output IP3 vs. Temperature @ 10 GHz

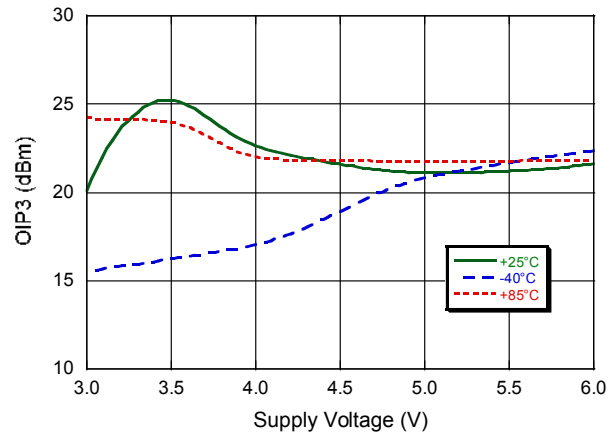

Output IP3 vs. Temperature for $V_{DD} = 3\text{ V}$

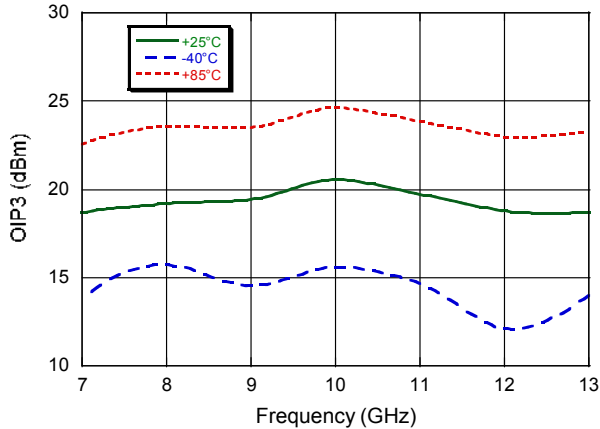

Output IP3 vs. Temperature for $V_{DD} = 4\text{ V}$

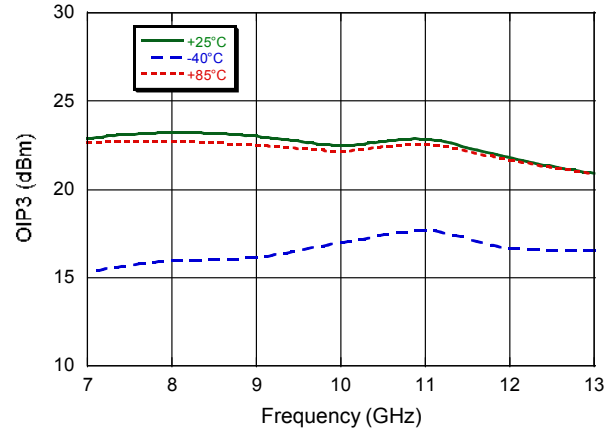

Output IP3 vs. Temperature for $V_{DD} = 5\text{ V}$

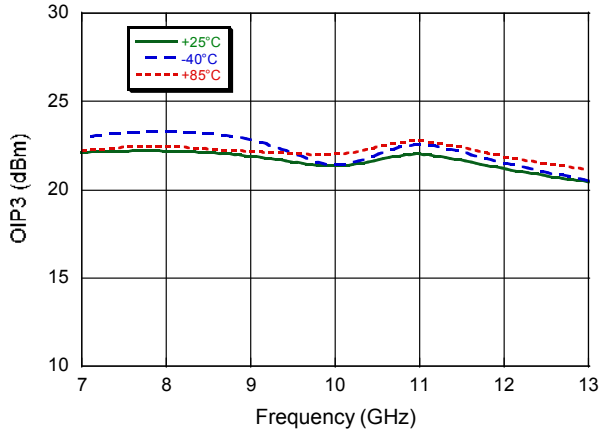

Typical Bias Current vs. Supply Voltage

$V_{DD1} = V_{DD2}$ (V)	I_{DD1} (mA)	I_{DD2} (mA)
3	14.6	43.4
4	15.2	44.5
5	15.6	45.0
6	15.8	45.1

Lead-Free 3 mm 16-Lead PQFN[†]

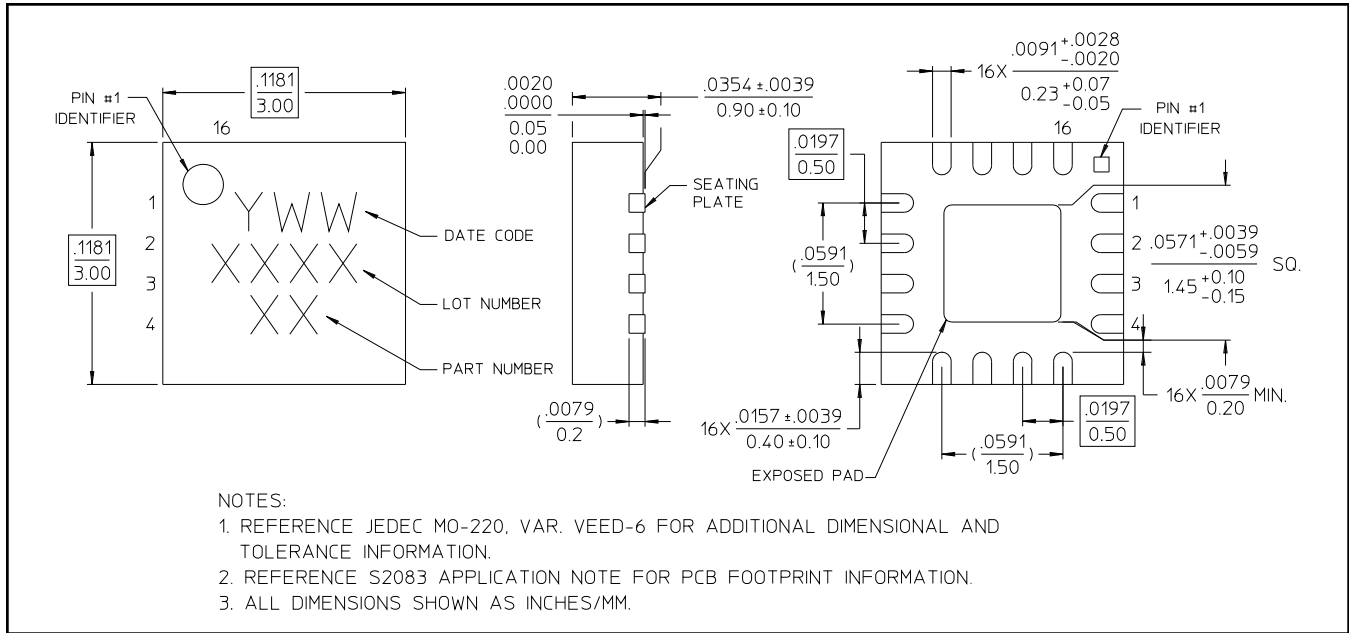

[†] Reference Application Note S2083 for lead-free solder reflow recommendations.
 Meets JEDEC moisture sensitivity level 1 requirements.
 Plating is 100% matte tin plating over copper

Mouser Electronics

Authorized Distributor

Click to View Pricing, Inventory, Delivery & Lifecycle Information:

[MACOM:](#)

[MAAL-010528-TR500](#) [MAAL-010528](#)