



AOB420, AOB420L (Green Product)
N-Channel Enhancement Mode Field Effect Transistor

General Description

The AOB420 uses advanced trench technology to provide excellent $R_{DS(ON)}$, low gate charge and low gate resistance. This device is ideally suited for use as a high side switch in CPU core power conversion. AOB420L (Green Product) is offered in a Lead Free package.

Features

- V_{DS} (V) = 30V
- I_D = 110A
- $R_{DS(ON)} < 6.5m\Omega$ ($V_{GS} = 10V$)
- $R_{DS(ON)} < 10.0m\Omega$ ($V_{GS} = 4.5V$)

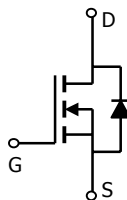
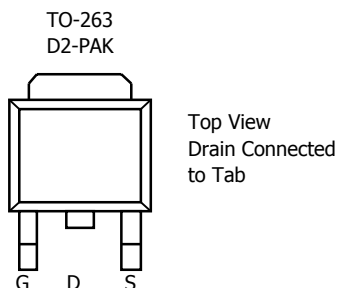

Absolute Maximum Ratings $T_A=25^\circ C$ unless otherwise noted

Parameter	Symbol	Maximum	Units
Drain-Source Voltage	V_{DS}	30	V
Gate-Source Voltage	V_{GS}	± 20	V
Continuous Drain Current ^{B,G}	I_D	$T_C=25^\circ C^G$	A
		$T_C=100^\circ C^B$	
Pulsed Drain Current	I_{DM}	200	
Avalanche Current ^C	I_{AR}	30	A
Repetitive avalanche energy $L=0.1mH^C$	E_{AR}	120	mJ
Power Dissipation ^B	P_D	$T_C=25^\circ C$	W
		$T_C=100^\circ C$	
Power Dissipation ^A	P_{DSM}	$T_A=25^\circ C$	W
		$T_A=70^\circ C$	
Junction and Storage Temperature Range	T_J, T_{STG}	-55 to 175	$^\circ C$

Thermal Characteristics

Parameter	Symbol	Typ	Max	Units
Maximum Junction-to-Ambient ^A	$R_{\theta JA}$	8.1	12	$^\circ C/W$
Maximum Junction-to-Ambient ^A		Steady-State	33	40
Maximum Junction-to-Lead ^C	$R_{\theta JL}$	1	1.5	$^\circ C/W$

Electrical Characteristics (T_J=25°C unless otherwise noted)

Symbol	Parameter	Conditions	Min	Typ	Max	Units
STATIC PARAMETERS						
BV _{DSS}	Drain-Source Breakdown Voltage	I _D =250μA, V _{GS} =0V	30			V
I _{DSS}	Zero Gate Voltage Drain Current	V _{DS} =24V, V _{GS} =0V T _J =55°C			1 5	μA
I _{GSS}	Gate-Body leakage current	V _{DS} =0V, V _{GS} =±20V			100	nA
V _{GS(th)}	Gate Threshold Voltage	V _{DS} =V _{GS} , I _D =250μA	1.5	2.15	2.5	V
I _{D(ON)}	On state drain current	V _{GS} =10V, V _{DS} =5V	110			A
R _{DS(ON)}	Static Drain-Source On-Resistance	V _{GS} =10V, I _D =30A T _J =125°C		5.05 7.7	6.5 11	mΩ
		V _{GS} =4.5V, I _D =30A		8.2	10	mΩ
g _{FS}	Forward Transconductance	V _{DS} =5V, I _D =30A		60		S
V _{SD}	Diode Forward Voltage	I _S =1A, V _{GS} =0V		0.72	1	V
I _S	Maximum Body-Diode Continuous Current				110	A
DYNAMIC PARAMETERS						
C _{iss}	Input Capacitance			1320		pF
C _{oss}	Output Capacitance	V _{GS} =0V, V _{DS} =15V, f=1MHz		533		pF
C _{rss}	Reverse Transfer Capacitance			154		pF
R _g	Gate resistance	V _{GS} =0V, V _{DS} =0V, f=1MHz		0.95		Ω
SWITCHING PARAMETERS						
Q _g (10V)	Total Gate Charge			25.5		nC
Q _g (4.5V)	Total Gate Charge	V _{GS} =4.5V, V _{DS} =15V, I _D =30A		13.3		nC
Q _{gs}	Gate Source Charge			3.2		nC
Q _{gd}	Gate Drain Charge			6.7		nC
t _{D(on)}	Turn-On Delay Time			7.7		ns
t _r	Turn-On Rise Time	V _{GS} =10V, V _{DS} =15V, R _L =0.5Ω,		28		ns
t _{D(off)}	Turn-Off Delay Time	R _{GEN} =3Ω		22.2		ns
t _f	Turn-Off Fall Time			20.7		ns
t _{rr}	Body Diode Reverse Recovery Time	I _F =30A, dI/dt=100A/μs		30.7		ns
Q _{rr}	Body Diode Reverse Recovery Charge	I _F =30A, dI/dt=100A/μs		21.8		nC

A: The value of R_{θJA} is measured with the device mounted on 1in² FR-4 board with 2oz. Copper, in a still air environment with T_A=25°C. The Power dissipation P_{DSM} is based on steady-state R_{θJA} and the maximum allowed junction temperature of 150°C. The value in any a given application depends on the user's specific board design, and the maximum temperature fo 175°C may be used if the PCB or heatsink allows it.

B. The power dissipation P_D is based on T_{J(MAX)}=175°C, using junction-to-case thermal resistance, and is more useful in setting the upper dissipation limit for cases where additional heatsinking is used. It is used to determine the current rating, when this rating falls below the package limit.

C: Repetitive rating, pulse width limited by junction temperature T_{J(MAX)}=175°C.

D. The R_{θJA} is the sum of the thermal impedance from junction to case R_{θJC} and case to ambient.

E. The static characteristics in Figures 1 to 6 are obtained using <300μs pulses, duty cycle 0.5% max.

F. These tests are performed with the device mounted on 1 in² FR-4 board with 2oz. Copper, in a still air environment with T_A=25°C. The SOA curve provides a single pulse rating.

G. The maximum current rating is limited by the package current capability.

THIS PRODUCT HAS BEEN DESIGNED AND QUALIFIED FOR THE CONSUMER MARKET. APPLICATIONS OR USES AS CRITICAL COMPONENTS IN LIFE SUPPORT DEVICES OR SYSTEMS ARE NOT AUTHORIZED. AOS DOES NOT ASSUME ANY LIABILITY ARISING OUT OF SUCH APPLICATIONS OR USES OF ITS PRODUCTS. AOS RESERVES THE RIGHT TO IMPROVE PRODUCT DESIGN, FUNCTIONS AND RELIABILITY WITHOUT NOTICE

TYPICAL ELECTRICAL AND THERMAL CHARACTERISTICS

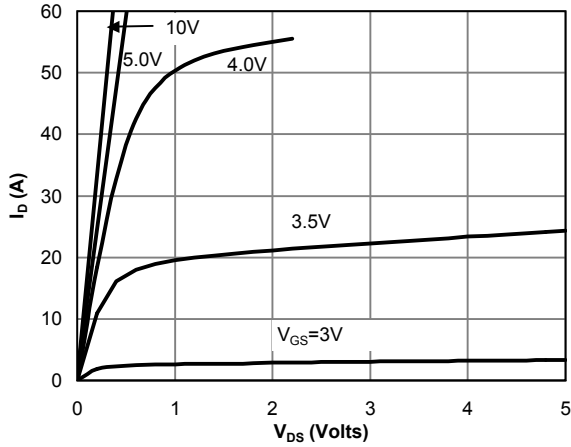

Fig 1: On-Region Characteristics

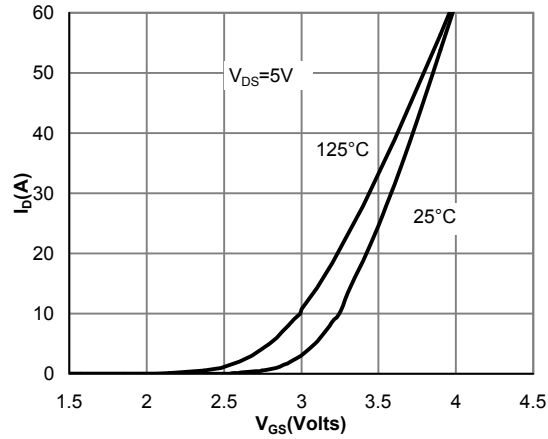

Figure 2: Transfer Characteristics

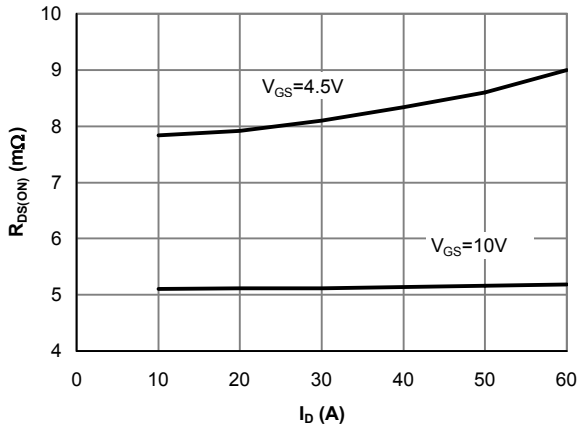

Figure 3: On-Resistance vs. Drain Current and Gate Voltage

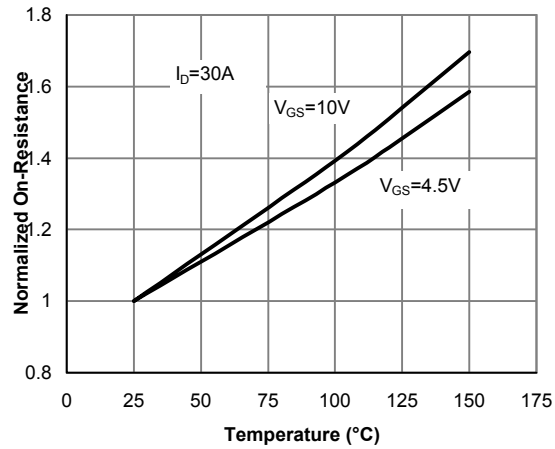

Figure 4: On-Resistance vs. Junction Temperature

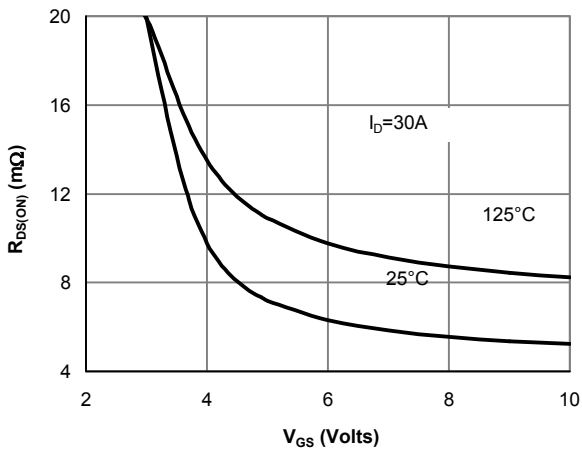

Figure 5: On-Resistance vs. Gate-Source Voltage

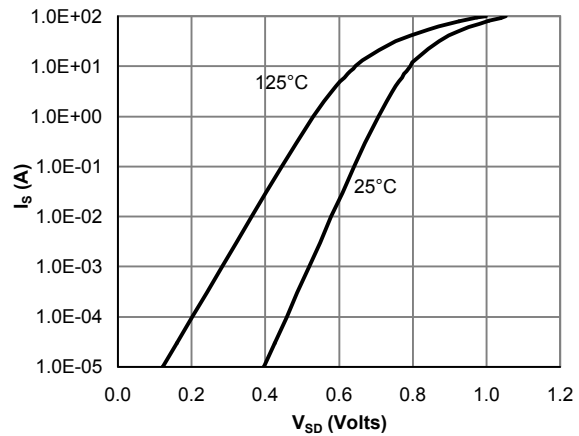

Figure 6: Body-Diode Characteristics

TYPICAL ELECTRICAL AND THERMAL CHARACTERISTICS

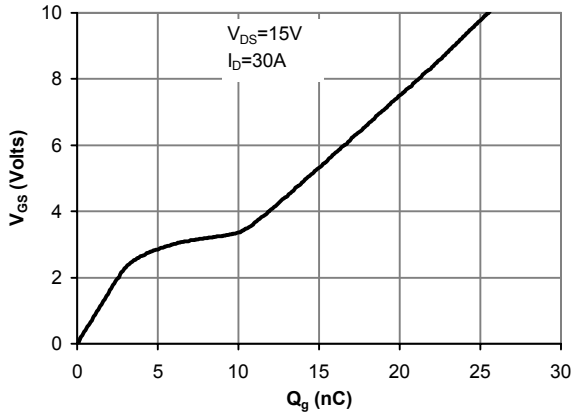

Figure 7: Gate-Charge Characteristics

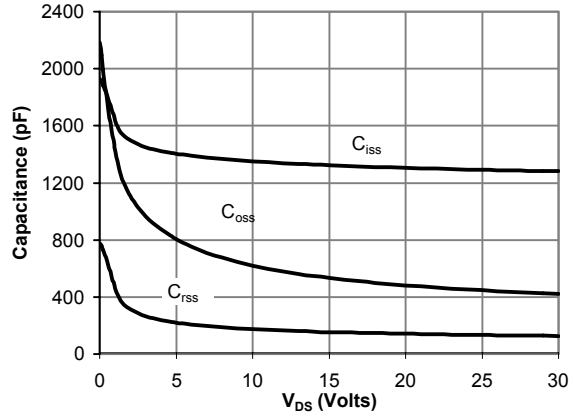

Figure 8: Capacitance Characteristics

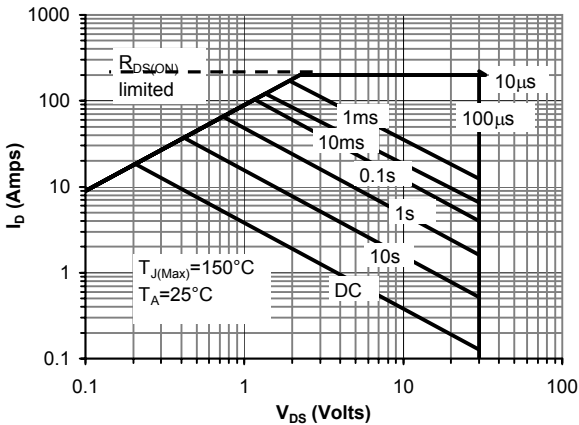

Figure 9: Maximum Forward Biased Safe Operating Area (Note F)

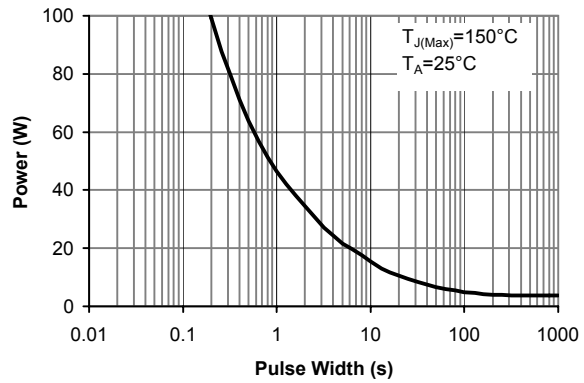

Figure 10: Single Pulse Power Rating Junction-to-Ambient (Note F)

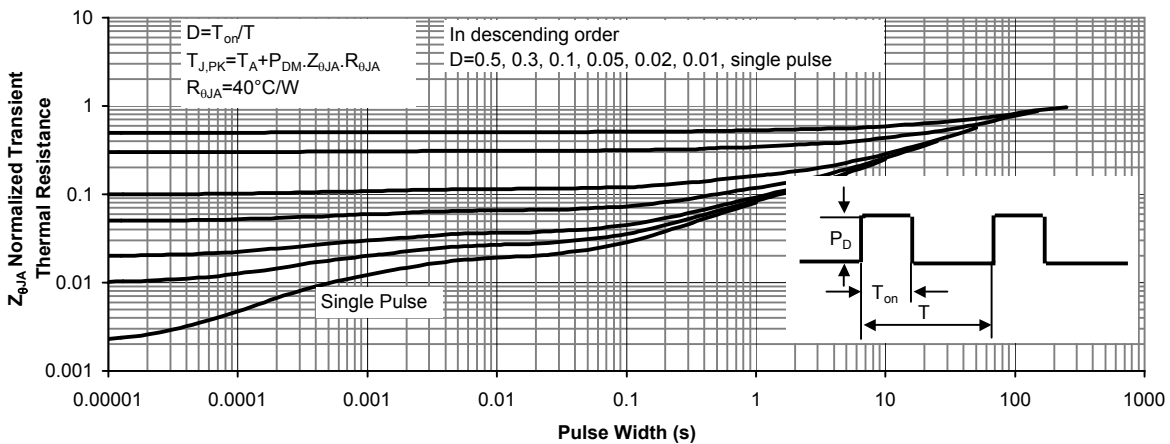
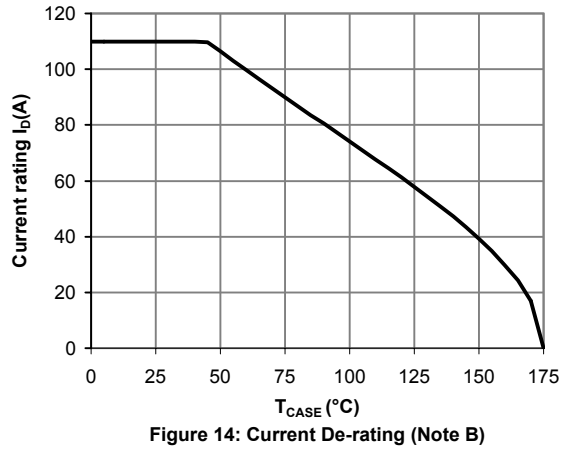
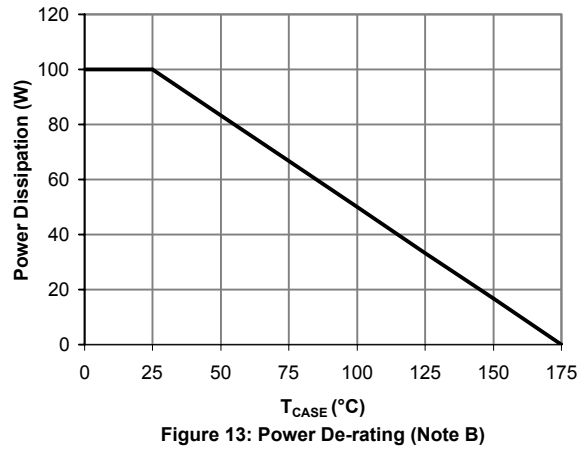
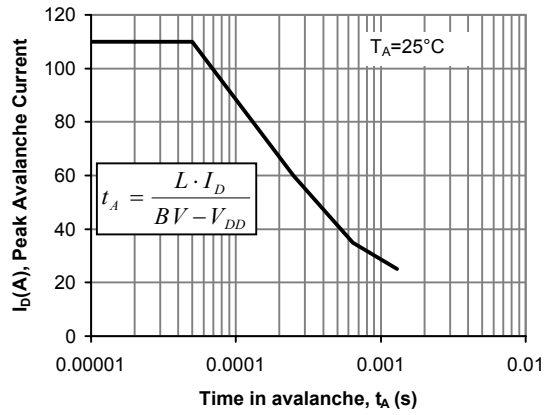

Figure 11: Normalized Maximum Transient Thermal Impedance (Note F)

TYPICAL ELECTRICAL AND THERMAL CHARACTERISTICS





ALPHA & OMEGA
SEMICONDUCTOR, LTD.

Document No.	PD-00081
Version	rev C
Title	AOB420 Marking Description

D2PAK PACKAGE MARKING DESCRIPTION

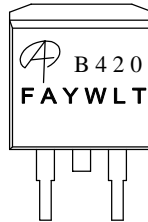

Standard product

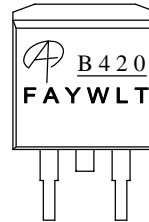

Green product

NOTE:
LOGO - AOS LOGO
B420 - PART NUMBER CODE.
F&A - FOUNDRY AND ASSEMBLY LOCATION
Y - YEAR CODE
W - WEEK CODE.
L T - ASSEMBLY LOT CODE

PART NO.	DESCRIPTION	CODE
AOB420	Standard product	B420
AOB420L	Green product	<u>B420</u>



D2PAK TO-263 PACKAGE OUTLINE

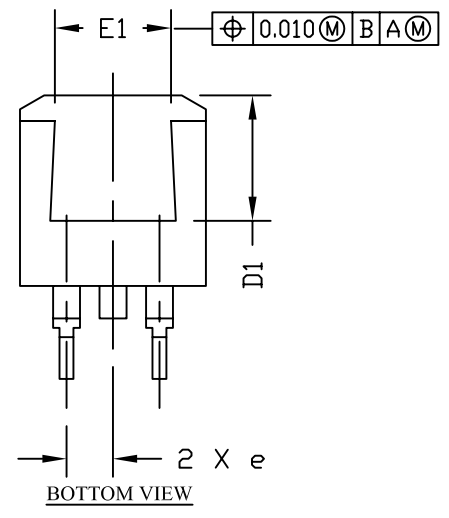
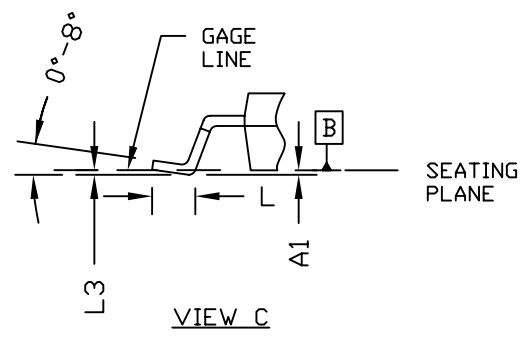
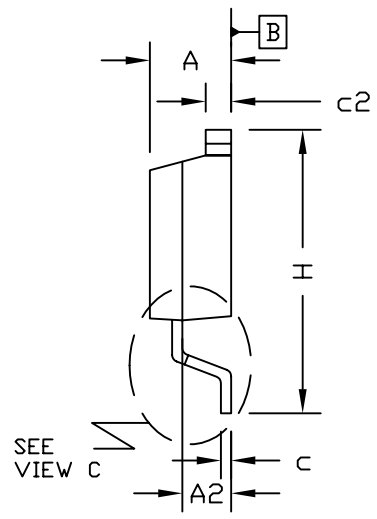
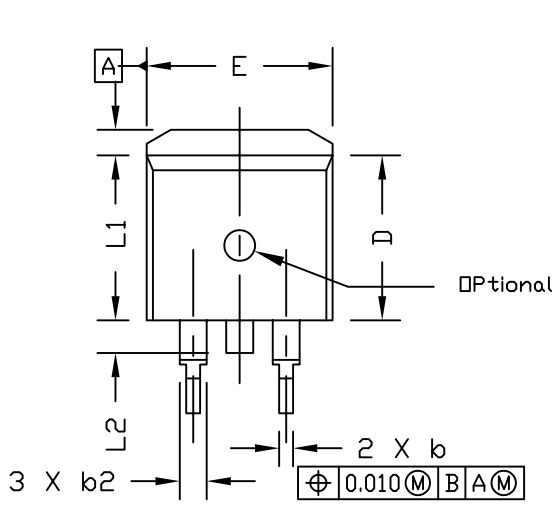

RECOMMENDED LAND PATTERN

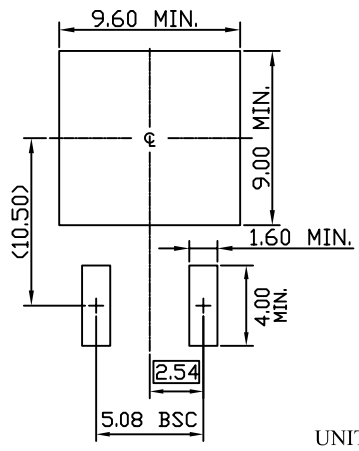

UNIT: mm

SYMBOLS	DIMENSIONS IN MILLIMETERS			DIMENSIONS IN INCHES		
	MIN	NOM	MAX	MIN	NOM	MAX
A	4.24	4.45	4.72	0.167	0.175	0.186
A1	0.00	---	0.30	0.000	---	0.012
A2	2.52	2.67	2.82	0.099	0.105	0.111
b	0.69	0.81	1.06	0.027	0.032	0.042
b2	1.07	1.27	1.47	0.042	0.050	0.058
c	0.30	0.38	0.56	0.012	0.015	0.022
c2	1.15	1.27	1.45	0.045	0.050	0.057
D	8.30	9.14	9.65	0.327	0.360	0.380
D1	---	---	6.93	---	---	0.273
e	2.54 BSC			0.100 BSC.		
E	9.70	10.03	10.54	0.382	0.395	0.415
E1	6.22	---	---	0.245	---	---
H	14.20	15.24	15.80	0.559	0.600	0.622
L	2.29	2.54	2.79	0.090	0.100	0.110
L1	1.40 BSC			0.055 BSC.		
L2	1.27	1.52	1.78	0.50	0.60	0.070
L3	0.25 BSC			0.010 BSC.		

NOTE:

- PACKAGE BODY SIDES EXCLUDE MOLD FLASH AND GATE BURRS. MOLD FLASH SHOULD BE LESS THAN 6 MILS.
- TOLERANCE 0.10 MILLIMETERS UNLESS OTHERWISE SPECIFIED.
- DIMENSION L IS MEASURED IN GAGE LINE.
- CONTROLLING DIMENSION IS MILLIMETER.
CONVERTED INCH DIMENSIONS ARE NOT NECESSARILY EXACT.
- REFER TO JEDEC TO-263 AB.



TO-263 (D2PAK) Carrier Tape

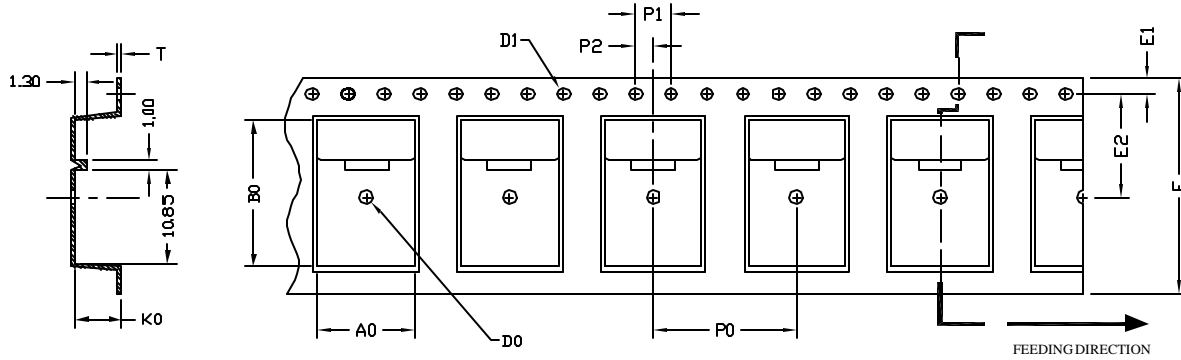

UNIT: MM

PACKAGE	A0	B0	K0	D0	D1	E	E1	E2	P0	P1	P2	T
TO-263(D2PAK) (24 mm)	10.80 ±0.10	16.30 ±0.10	4.85 ±0.10	1.50 ±0.10	1.50 MIN.	24.00 ±0.30	1.75 ±0.10	11.50 ±0.10	16.00 ±0.10	4.00 ±0.10	2.00 ±0.10	0.35 ±0.05

TO-263 (D2PAK) Reel

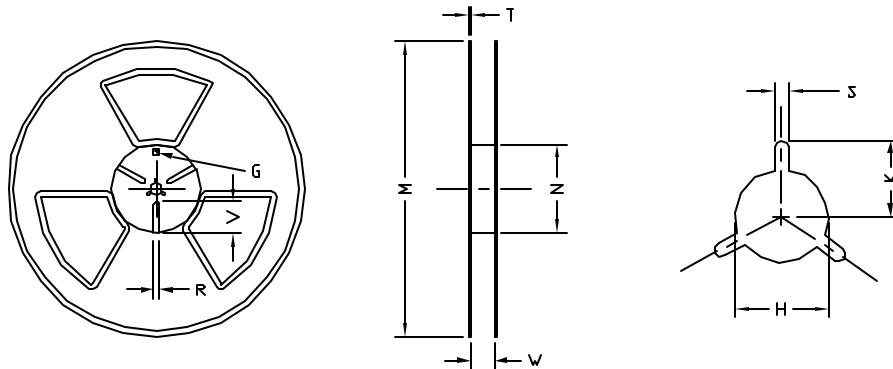

UNIT: MM

TAPE SIZE	REEL SIZE	M	N	W	T	H	K	S	G	R	V
24 mm	ø330	ø330.00 ±0.10	ø99.50 ±0.10	25.50 ±0.50	2.30	ø13.50 ±0.10	10.60	2.50 ±0.10	---	---	---

TO-263 (D2PAK)

Leader / Trailer
& Orientation

